

CC 68.1250-1

1375 US TON CAPACITY





February 2022. Unless otherwise specified, all information in this brochure refers to a standard crane equipment, and it is intended as general information only. No liability is assumed. Errors reserved. Product specifications and prices are subject to changes without notice. The photographs and/or drawings in this brochure are for illustrative purposes only. For correct and safe crane operation, the original operating manual and lifting capacity charts are essential. Failure to follow the corresponding Operator's Manual when using our equipment or failure to otherwise act responsibly may result in property damage, serious injury or death. The sole warranty applicable with respect to our equipment is the standard warranty as per general terms and conditions of sales and service (ask your local Tadano dealer for details), and Tadano makes no other warranty, express or implied. All rights reserved. Any use of the trademarks, logos, brand names and model names used herein is prohibited.

© Tadano Ltd. 2022

Contents

Specifications	7
Working speeds.....	8
Hook block system	9
Hook block	9
Number of lines	9-10
Counterweight.....	10
Basic crane dimensions.....	11-13
Superlift configurations.....	14
Transportation	15-16
Boom heads.....	16
Erection / lowering of the boom systems to the ground	17
Boom combinations	18-21
Main boom	23
SH, SH/LH, LH.....	24-27
SSL, SSL/LSL, SSL/LSL S1	28-35
Fixed fly jib	37
SH+LF	38-41
SH/LH+LF.....	42-50
SH/LH+LF3 S3	52-54
SSL+LF, SSL/LSL S1+LF	56-77
Luffing fly jib	79
SW	80-84
SWSL, SFSL.....	86-113
Fixed fly jib with SL	115
SFVL, LFVL	116-117
Notes to Lifting Capacity	118
Technical description	120-121

Key



Track



Counterweight + central ballast (ZB)



Superlift counterweight



Central ballast



Superlift radius



Possible load of hook block



Weight of hook block



Load radius



Main boom



Fly jib



Main boom angle



Fly jib angle



Hook block



Hoist 1



Hoist 2



Hoist 3



Jib luffing



Boom derricking



Boom hoist



Travel speed



Working speeds



Slewing



Max. line pull



Rope diameter



Rope length



Number of lines



Number of sheaves



Wind speed in ft/s (feet per second)

Key



Distance head sheave axle – hook ground

S: heavy

L: light

H/HA: Main boom

HI: Luffing jib

W: Luffing fly jib

F: Fixed fly jib

SL: Superlift

V: Vessellift

SGL: Heavy base length

Highlights

Excellent lifting capacities throughout all working ranges, especially with luffing fly jib

Max. load moment 114.700 ft-kips (2185,000 lb @ 52.5 ft)

Two redundant operating drivelines

Highly simplified assembly processes for short rigging times

Hydraulic quick-connection

Innovative IC-1 crane control system with touchscreen

Superlift radius infinitely variable during operation from 49.2 – 78.7 ft (+ 78.7 – 98.4 ft)

Variable offset of main boom with SW and SWSL configurations

Powerful Quadro-Drive as standard

Hydraulic assisted pinning of boom sections is standard

PC outrigger optional

SPECIFICATIONS









Specifications







Working speeds (infinitely variable)				
				
	max. 361 ft/min	53.700 lbf	1.26"	4068 ft
	max. 361 ft/min	53.700 lbf	1.26"	4068 ft
	max. 328 ft/min	53.700 lbf	1.26"	2297 ft
	max. 361 ft/min		1.26"	
	max. 164 ft/min		1.26"	
	max. 344 ft/min		1.26"	
	1,2 rpm			
	max. 0.68 mph			













1) top layer

Specifications















Hook block system					
					
2 x 625	2756,200 lb 1389,200 lb 1389,200 lb 727,700 lb	2 x 15 2 x 7 15 7	2 x 31 2 x 15 31 15	64,000 lb 41,900 lb 41,900 lb 19,800 lb	25.9 ft 19.4 ft 19.4 ft 19.4 ft
1000	2205,000 lb 1102,500 lb 1102,500 lb 551,200 lb	2 x 11 2 x 5 11 5	2 x 23 2 x 11 23 11	39,700 lb 24,300 lb 17,600 lb 16,800 lb (12,800 lb*)	22.0 ft 23.6 ft (21.3 ft*) 23.6 ft (21.3 ft*) 23.6 ft (19.7 ft*)
800	1764,000 lb 1102,500 lb 1102,500 lb 551,200 lb	2 x 11 2 x 5 11 5	2 x 19 2 x 11 23 11	35,300 lb 24,300 lb 17,600 lb 16,800 lb (12,800 lb*)	21.3 ft 23.6 ft (21.3 ft*) 23.6 ft (21.3 ft*) 23.6 ft (19.7 ft*)

* with optional equipment 1102,500 lb hook

Hook block					
					
2 x 125	551,200 lb	2 x 3	2 x 6	10,600 lb – 26,200 lb	17.7 ft
2 x 95	418,900 lb	2 x 2	2 x 4	6,400 lb – 18,500 lb	17.7 ft
70	154,300 lb	1	3	8,600 lb	15.8 ft
25	50,700 lb	Single line hook	1	3,300 lb	13.1 ft

Number of lines																
	1	2	3	4	5	6	7	8	9	10	11	12	13	14	15	16
	52,900 lb	105,800 lb	156,500 lb	209,500 lb	260,200 lb	310,900 lb	361,600 lb	410,100 lb	460,800 lb	509,300 lb	557,900 lb	604,200 lb	652,700 lb	699,000 lb	745,300 lb	791,600 lb
	1 x 55,120 lb	X														
	1 x 154,300 lb		X	X												
	1 x 551,200 lb				X	X	X	X	X	X	X					
	1 x 727,600 lb				X	X	X	X	X	X	X	X	X	X	X	
	1 x 1102,500 lb				X	X	X	X	X	X	X	X	X	X	X	X
	1 x 1389,200 lb				X	X	X	X	X	X	X	X	X	X	X	X
	17	18	19	20	21	22	23	24	25							
	837,900 lb	882,000 lb	926,100 lb	970,200 lb	1014,300 lb	1058,400 lb	1100,300 lb	1142,200 lb	1084,100 lb							
	1 x 1102,500 lb	X	X	X	X	X	X									
	1 x 1389,200 lb	X	X	X	X	X	X	X	X							

Specifications

Number of lines																
	2 x 1	2 x 2	2 x 3	2 x 4	2 x 5	2 x 6	2 x 7	2 x 8	2 x 9	2 x 10	2 x 11	2 x 12	2 x 13	2 x 14	2 x 15	2 x 16
		211,600 lb	313,000 lb	419,000 lb	520,400 lb	621,800 lb	723,200 lb	820,200 lb	921,600 lb	1018,600 lb	1115,800 lb	1208,400 lb	1305,400 lb	1398,000 lb	1490,600 lb	1583,200 lb
	2 x 209,500 lb	X	X	X	X											
	2 x 275,600 lb		X	X	X	X										
	2 x 551,200 lb			X	X	X	X	X	X	X	X					
	2 x 727,600 lb			X	X	X	X	X	X	X	X	X	X	X	X	
	2 x 882,000 lb			X	X	X	X	X	X	X	X	X	X	X	X	X
	2 x 1102,500 lb			X	X	X	X	X	X	X	X	X	X	X	X	X
	2 x 1378,100 lb			X	X	X	X	X	X	X	X	X	X	X	X	X
	2 x 17	2 x 18	2 x 19	2 x 20	2 x 21	2 x 22	2 x 23	2 x 24	2 x 25	2 x 26	2 x 27	2 x 28	2 x 29	2 x 30	2 x 31	
	1675,800 lb	1764,000 lb	1852,200 lb	1940,400 lb	2028,600 lb	2116,800 lb	2200,600 lb	2284,400 lb	2168,200 lb	2452,000 lb	2535,800 lb	2617,300 lb	2696,700 lb	2756,200 lb	2756,200 lb	
	2 x 882,000 lb	X	X	X												
	2 x 1102,500 lb	X	X	X	X	X	X									
	2 x 1378,100 lb	X	X	X	X	X	X	X	X	X	X	X	X	X	X	

Counterweight

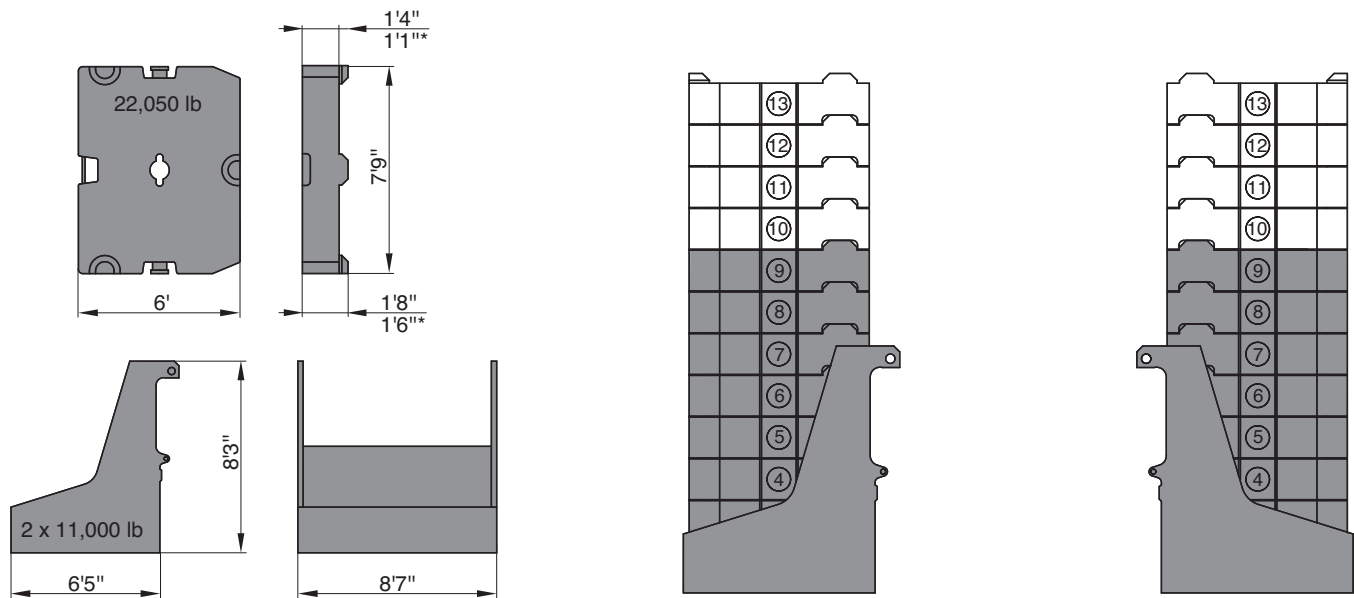

* Option

Specifications

Basic crane dimensions

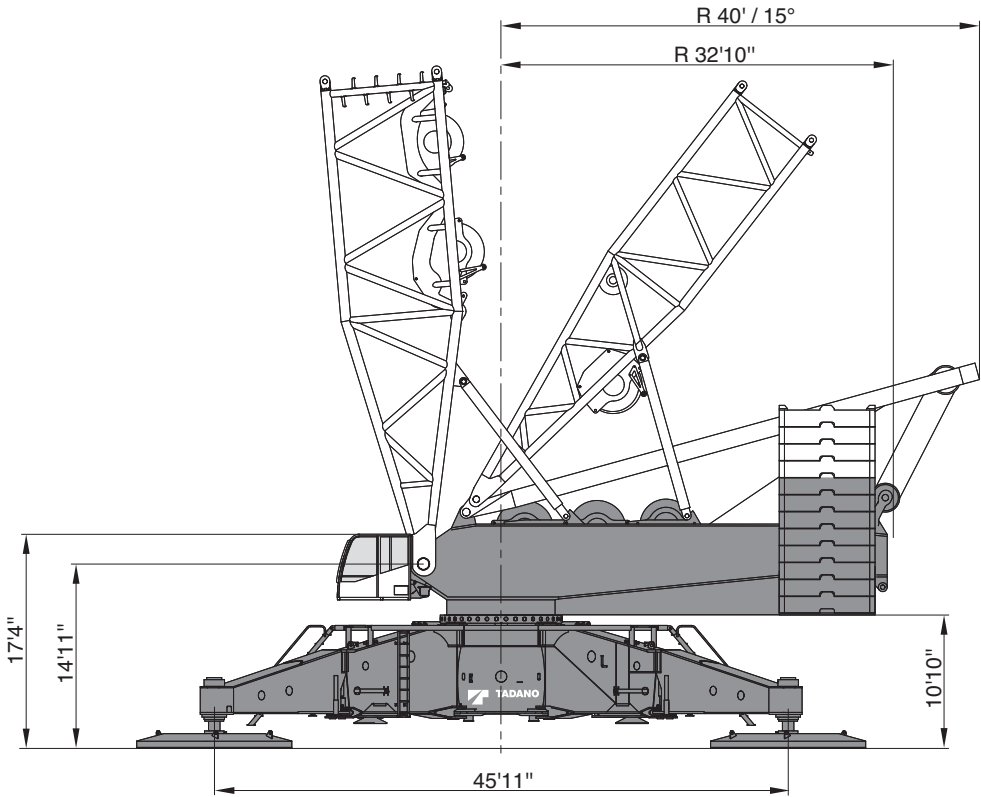
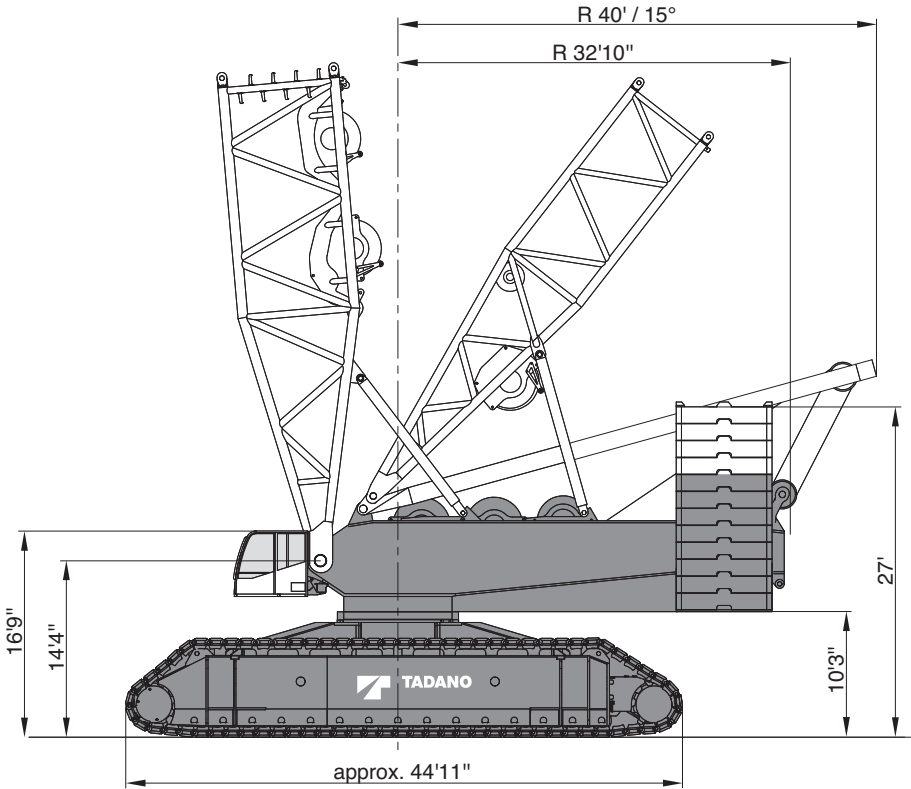

Specifications

Basic crane dimensions

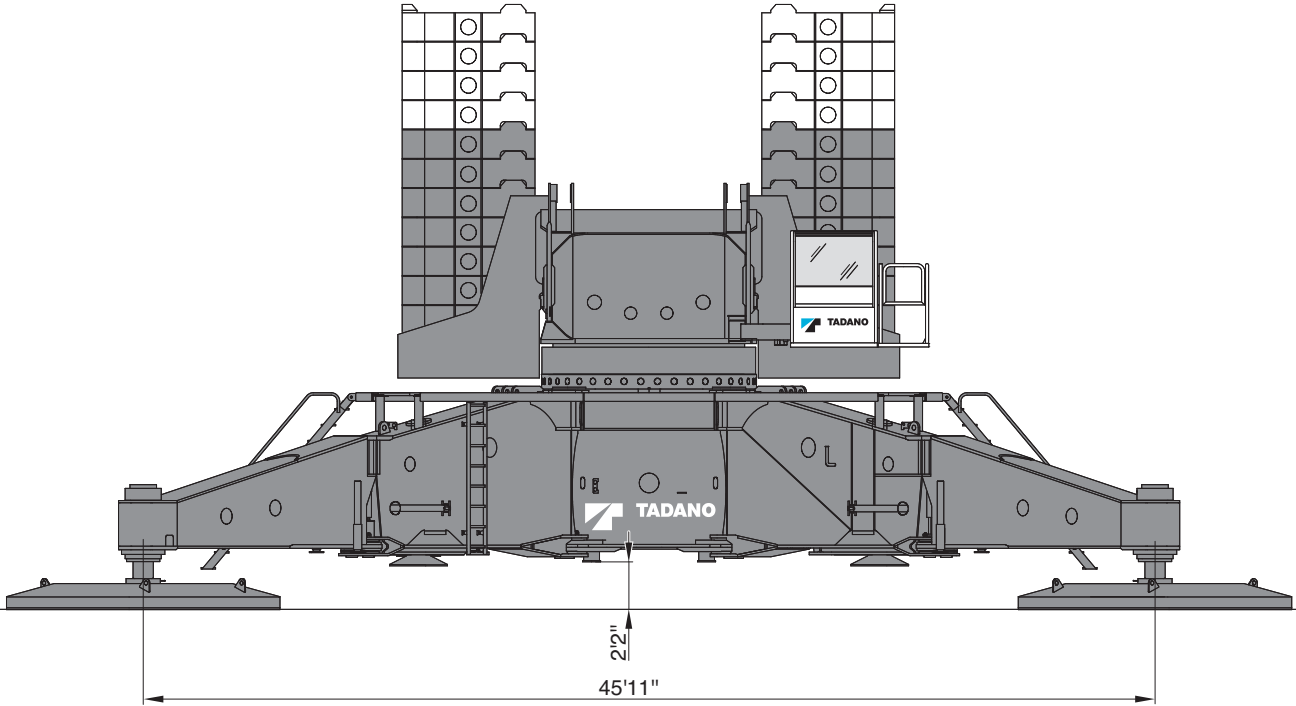
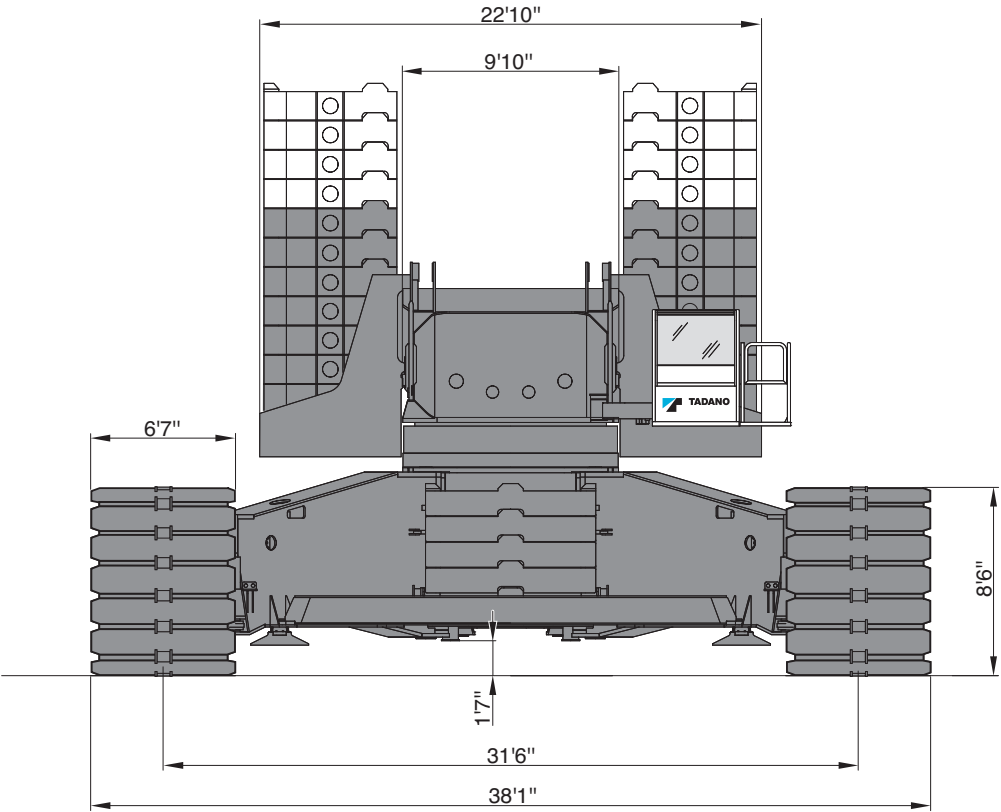

Specifications

Basic crane dimensions

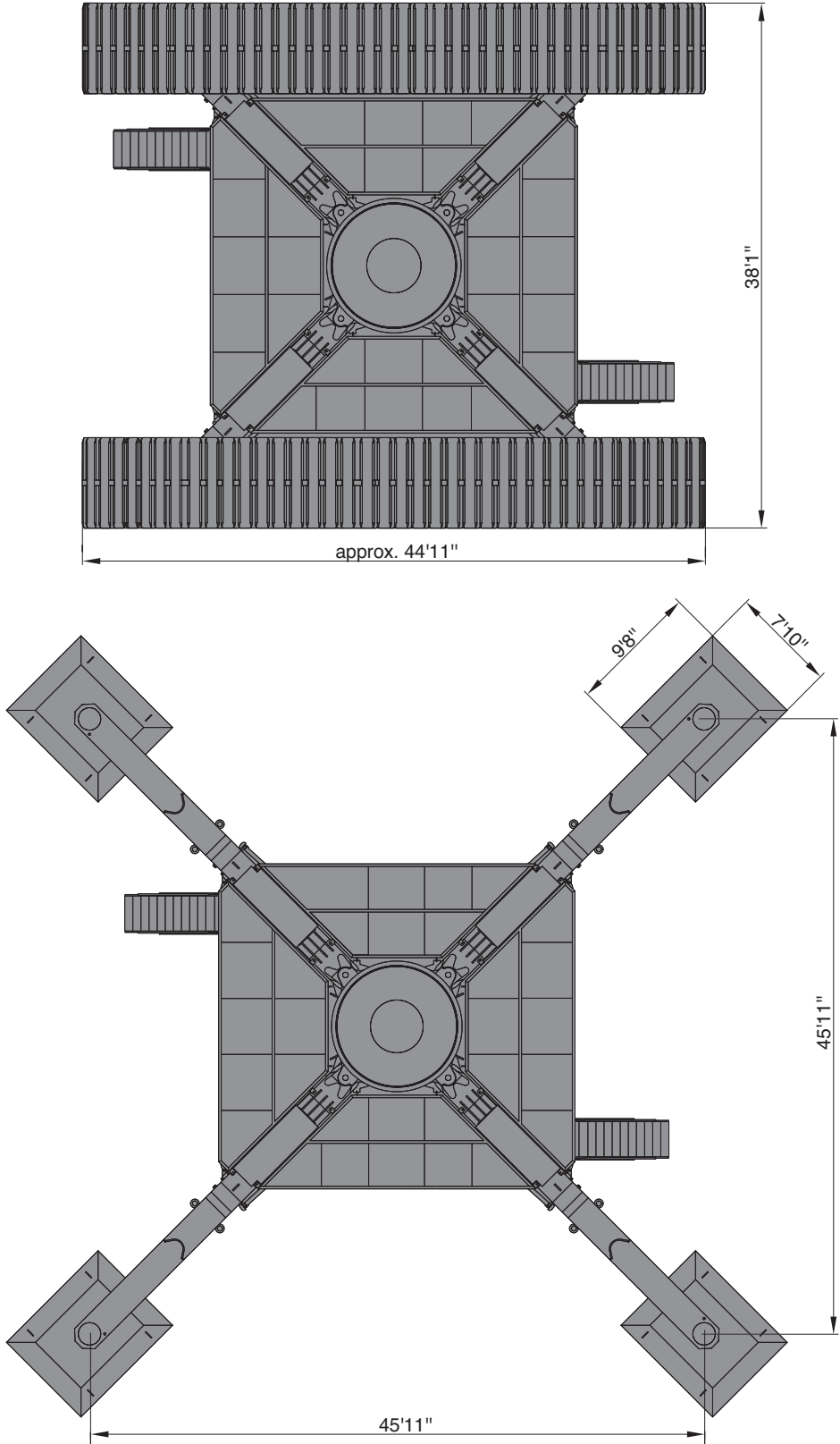

Specifications

Superlift configurations

Standard-SL

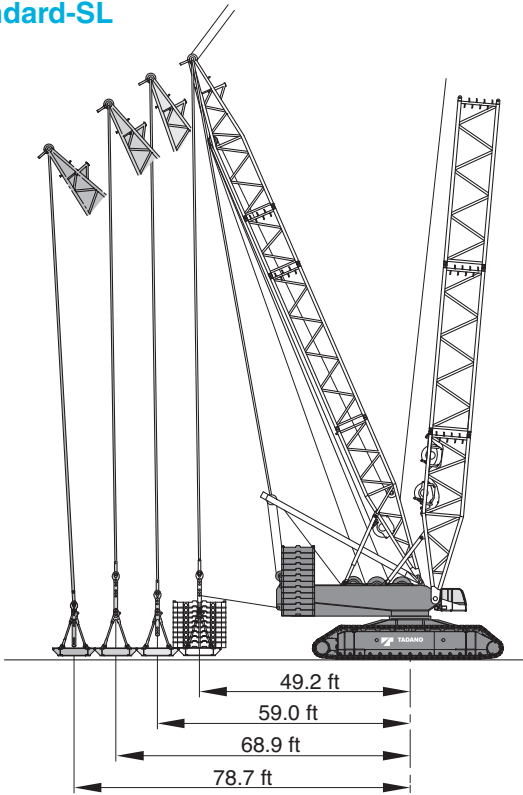

Vario-SL

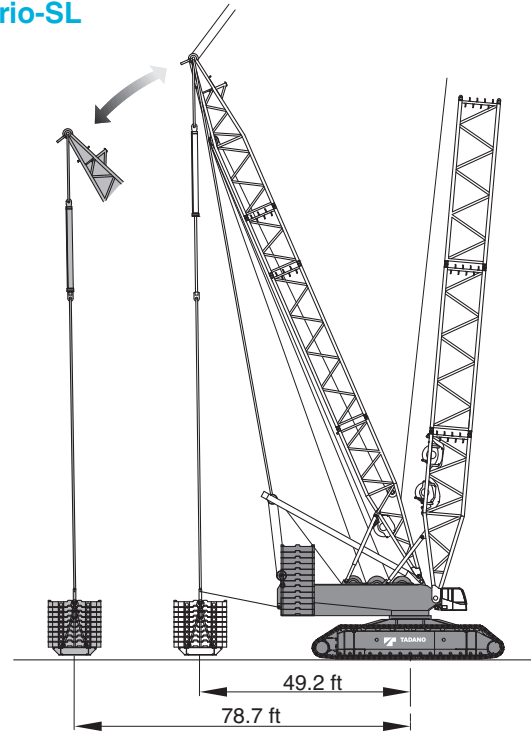

SL Carrier

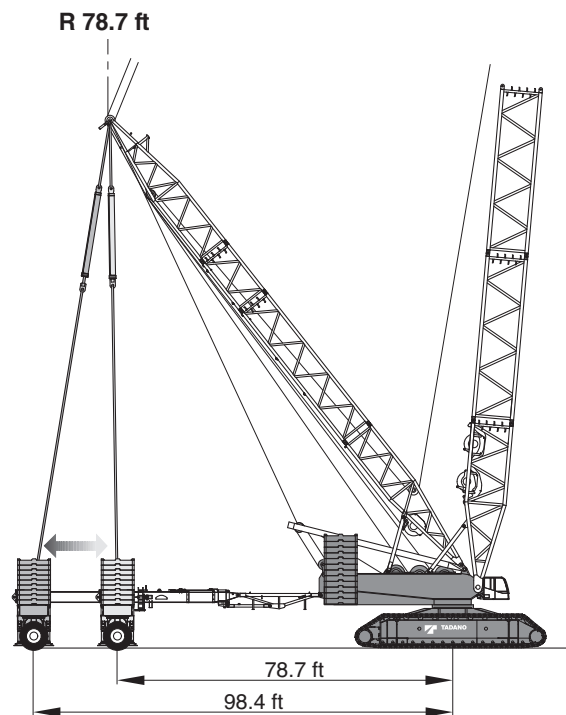
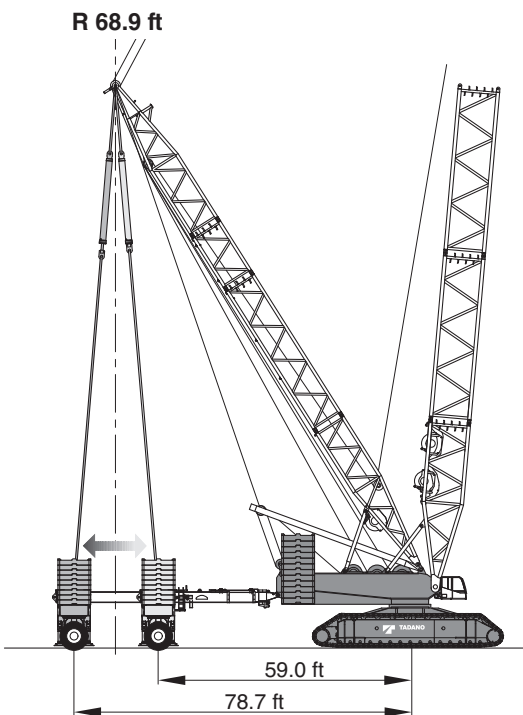

Alternatively, the telescope connector may be used in combination with the Superlift Tray

Specifications

Transportation

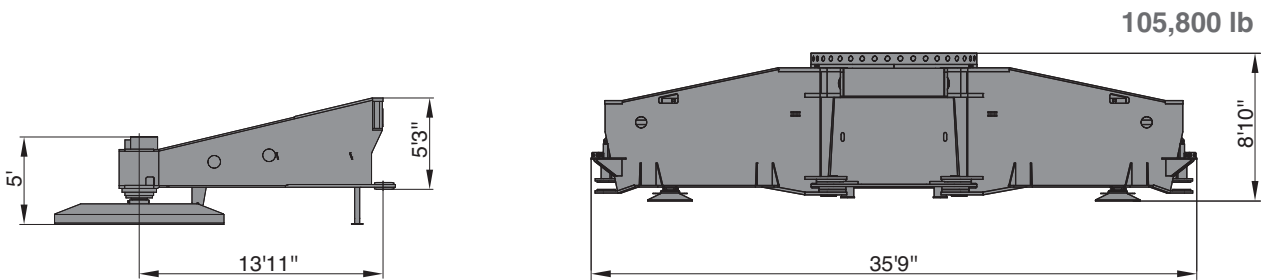
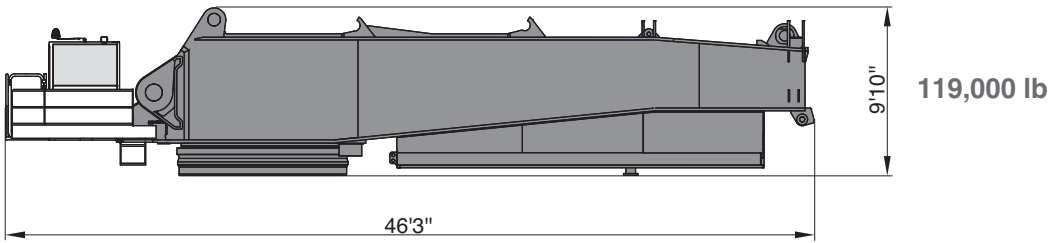
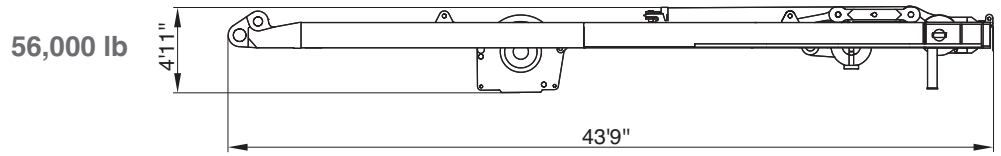
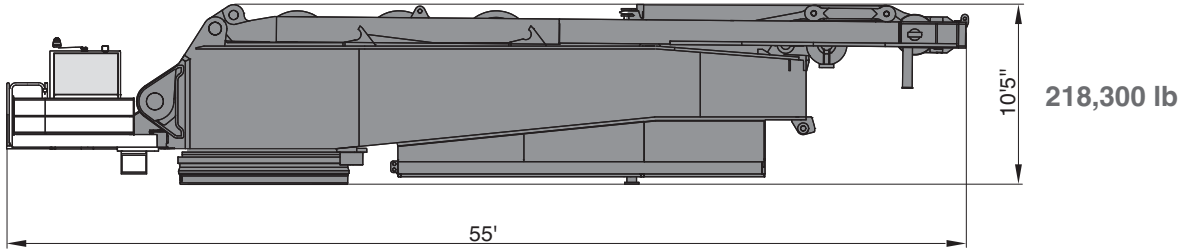

4 x 17,600 lb

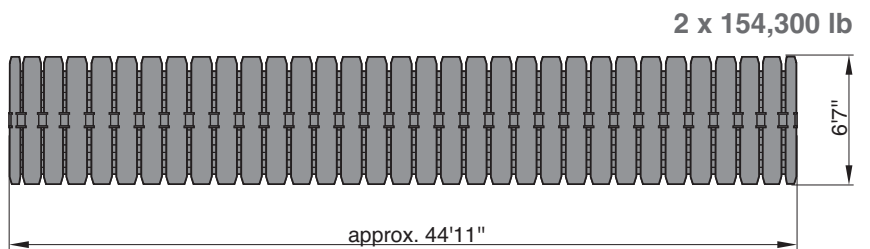
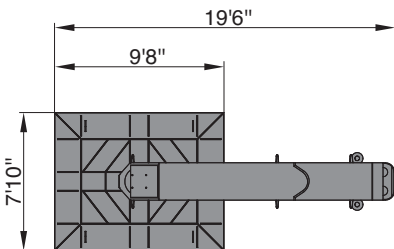

Specifications

Transportation

Main Boom (HA)

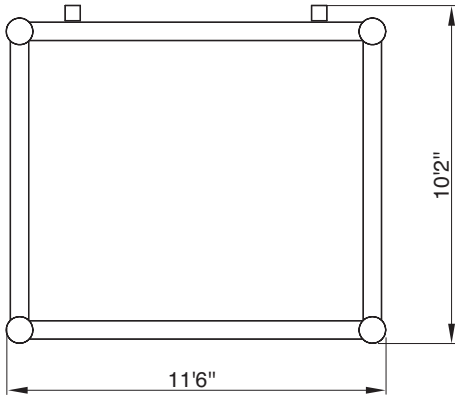

Type 3328

Jib (HI)

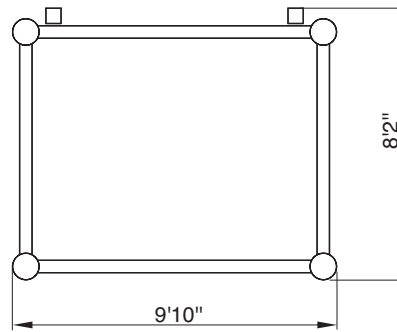

Type 2822

LF

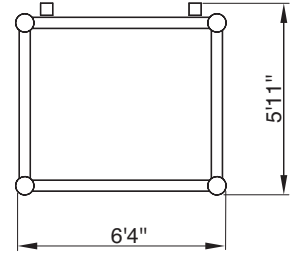

Type 1816A

S3: Add. 2420A (2570 x 2275)

LF3: 2016B (2235 x 1850)

Boom heads

A

(max. 2756,200 lb** / 2205,000 lb)

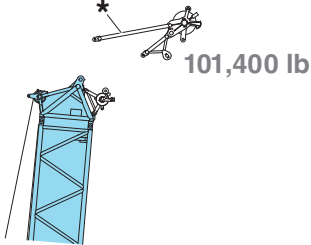

A1

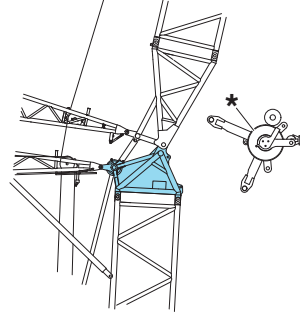

A2

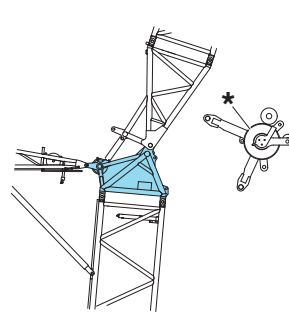

A3

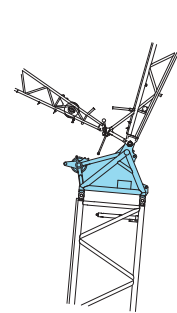

B

(max. 1122,400 lb)

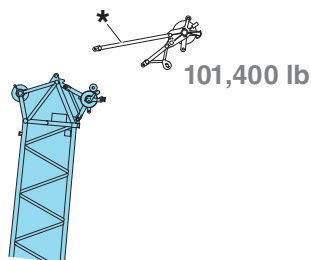

B1

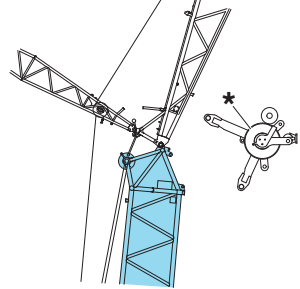

C

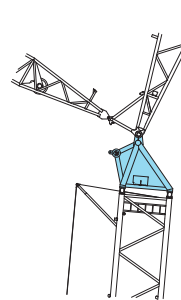

D

(max. 551,200 lb)



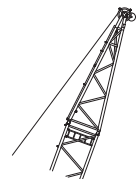

E

(max. 385,900 lb)



* Attachable ** Option

Specifications

Erection / lowering of the boom systems to the ground																	
374,800 – 551,200 lb + 0–176,400 lb																	
																	
	ft	ft	118.1	137.8	157.5	177.2	196.9	216.5	236.2	255.9	275.6	295.3	315.0	334.6	354.3	374.0	
SH			X	X	X	X	X	X	X	[X]	[X]	[X]	[X]	–	–	–	
SH+LF	49.2		–	–	–	–	–	[X]	[X]	[X]	–	–	–	–	–	–	
	68.9		–	–	–	–	–	[X]	[X]	[X]	–	–	–	–	–	–	
	88.6		–	–	–	–	–	[X]	[X]	[X]	–	–	–	–	–	–	
	108.3		–	–	–	–	–	[X]	[X]	[X]	–	–	–	–	–	–	
SH/LH			–	–	X	X	X	X	X	X	X	X	[X]	[X]	[X]	–	
SH/LH+LF	49.2		–	–	X	X	X	X	X	[X]	[X]	[X]	–	–	–	–	
	68.9		–	–	X	X	X	X	[X]	[X]	[X]	[X]	–	–	–	–	
	88.6		–	–	X	X	X	X	[X]	[X]	[X]	[X]	–	–	–	–	
	108.3		–	–	X	X	X	[X]	[X]	[X]	[X]	[X]	–	–	–	–	
LH			–	–	X	X	X	X	X	X	X	X	X	X	[X]	[X]	
SW  65°, 75°, 85°, 87°	78.7		–	X	X	[X]	[X]	–	–	–	–	–	–	–	–	–	
	98.4		–	X	X	[X]	[X]	–	–	–	–	–	–	–	–	–	
	118.1		–	X	X	[X]	[X]	–	–	–	–	–	–	–	–	–	
	137.8		–	X	X	X	[X]	–	–	–	–	–	–	–	–	–	
	157.5		–	X	X	X	[X]	–	–	–	–	–	–	–	–	–	
	177.2		–	X	X	X	[X]	–	–	–	–	–	–	–	–	–	
	196.9		–	X	X	[X]	[X]	–	–	–	–	–	–	–	–	–	
	216.5		–	X	X	[X]	[X]	–	–	–	–	–	–	–	–	–	
	236.2		–	X	X	[X]	–	–	–	–	–	–	–	–	–	–	
	255.9		–	X	X	[X]	–	–	–	–	–	–	–	–	–	–	
	275.6		–	X	X	[X]	–	–	–	–	–	–	–	–	–	–	
	295.3		–	X	X	[X]	–	–	–	–	–	–	–	–	–	–	
	315.0		–	X	X	[X]	–	–	–	–	–	–	–	–	–	–	
		ft								321.5	331.4	341.2	351.1	360.9	370.7	380.6	390.4
SH/LH+LF3_S3	49.2									[X]	[X]	[X]	[X]	[X]	[X]	[X]	[X]
	68.9									[X]	[X]	[X]	[X]	[X]	[X]	–	–

X without assisting equipment

[X] with additional side jack

All Superlift combinations can be erected or lowered to the ground without assisting equipment.

Specifications

Boom combinations

Type 3328

Type 2822

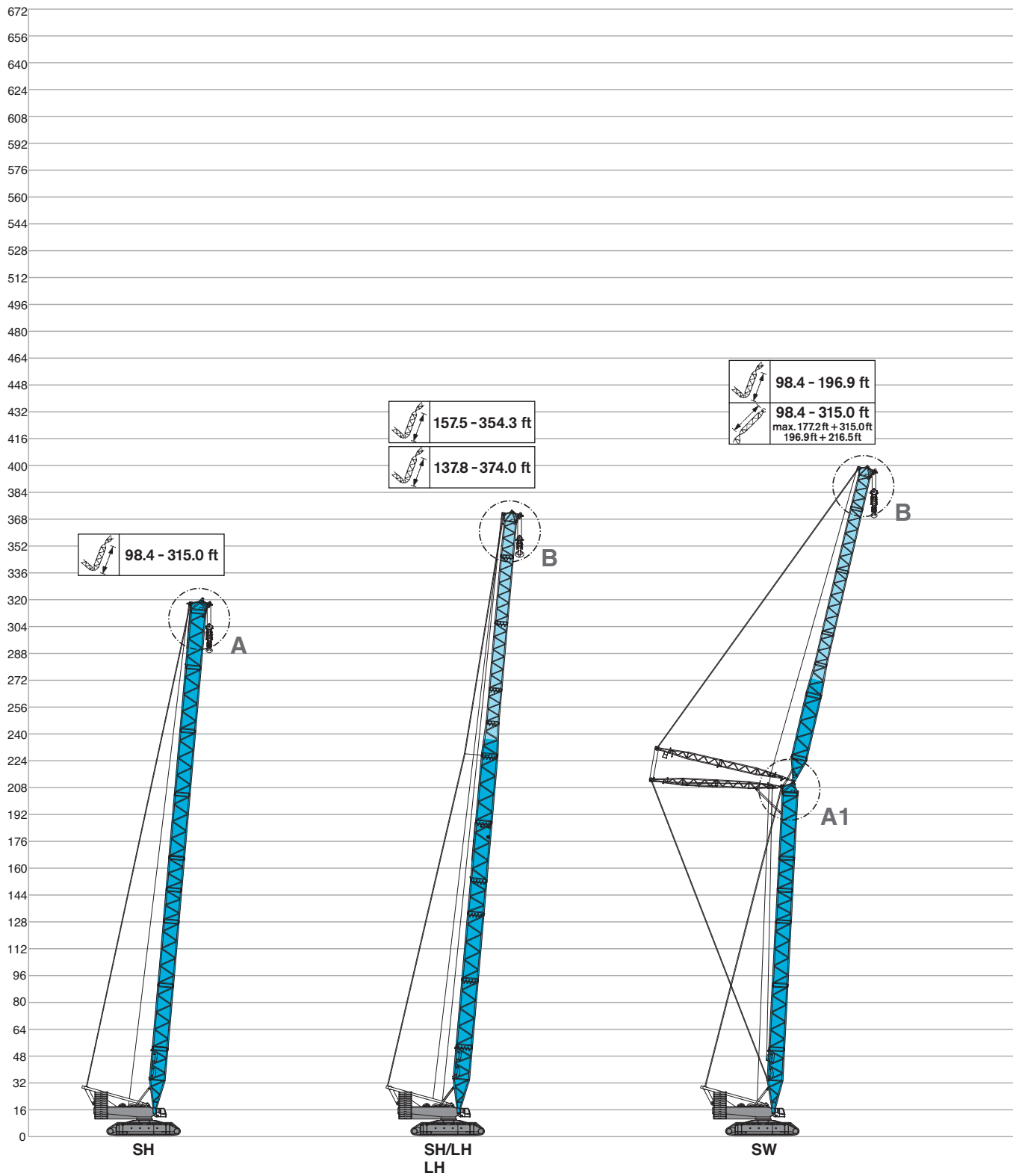

Specifications

Boom combinations

Type 3328

Type 2822

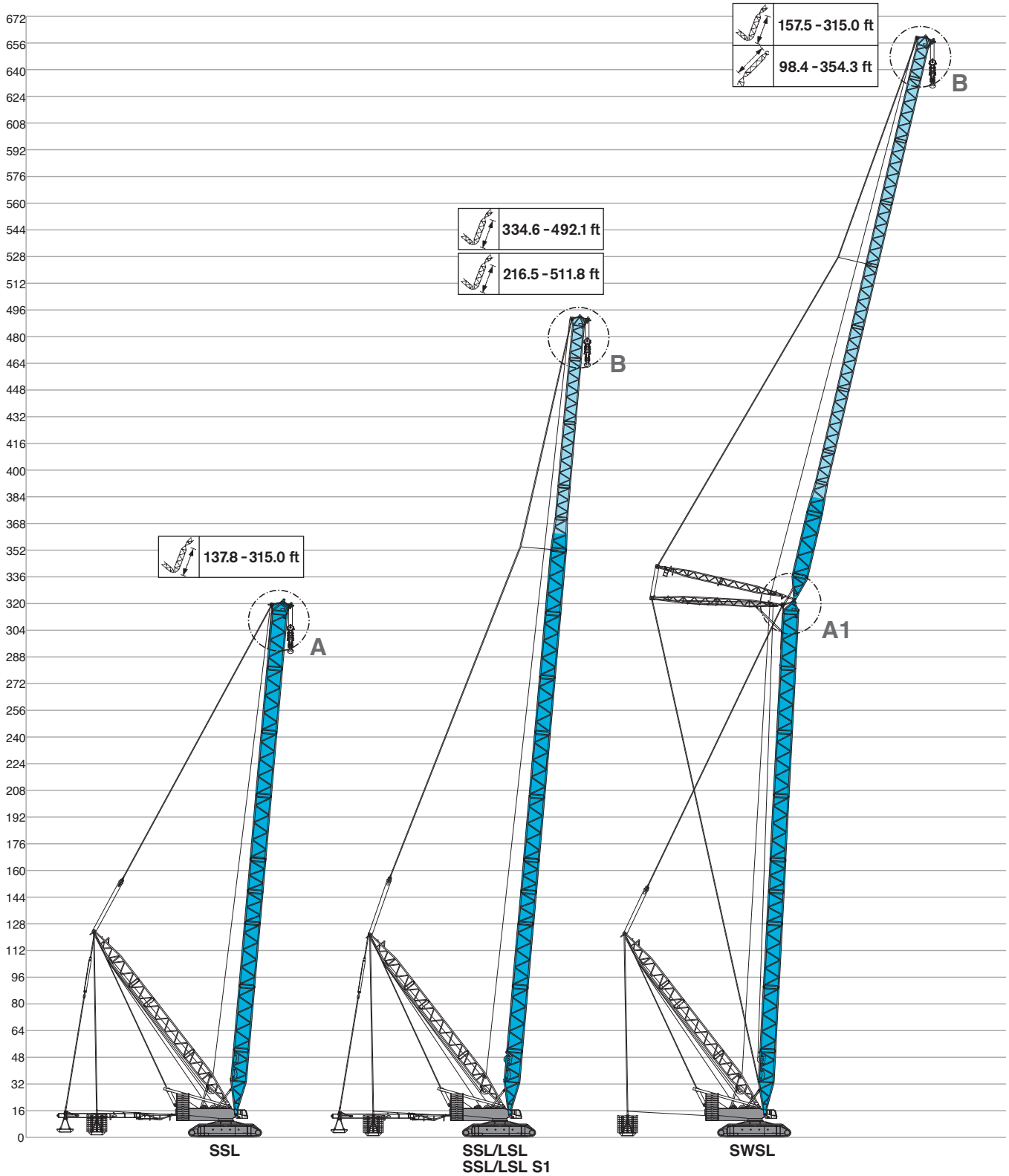

Specifications

Boom combinations

Type 3328

Type 2822

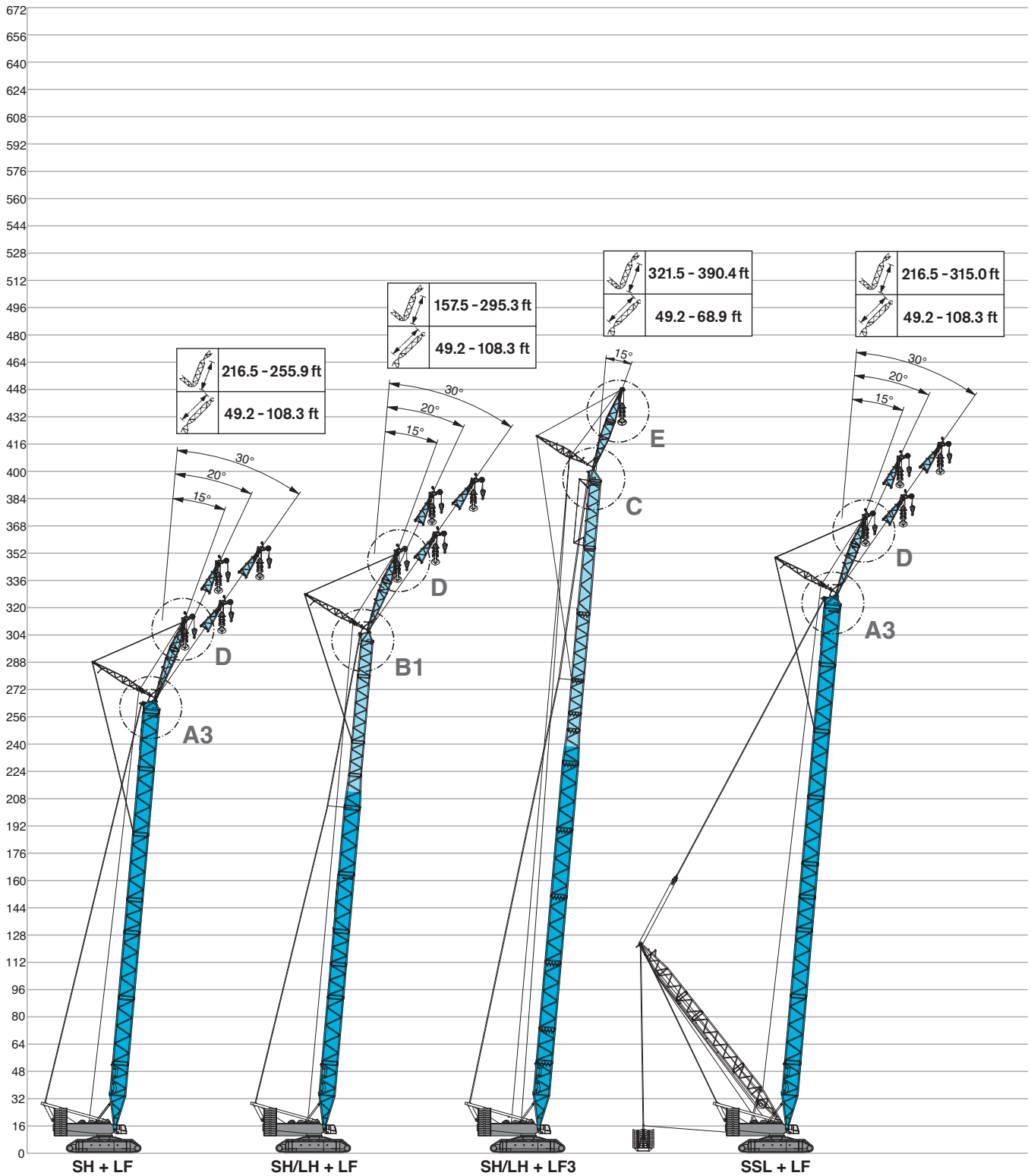

Specifications

Boom combinations

Type 3328

Type 2822

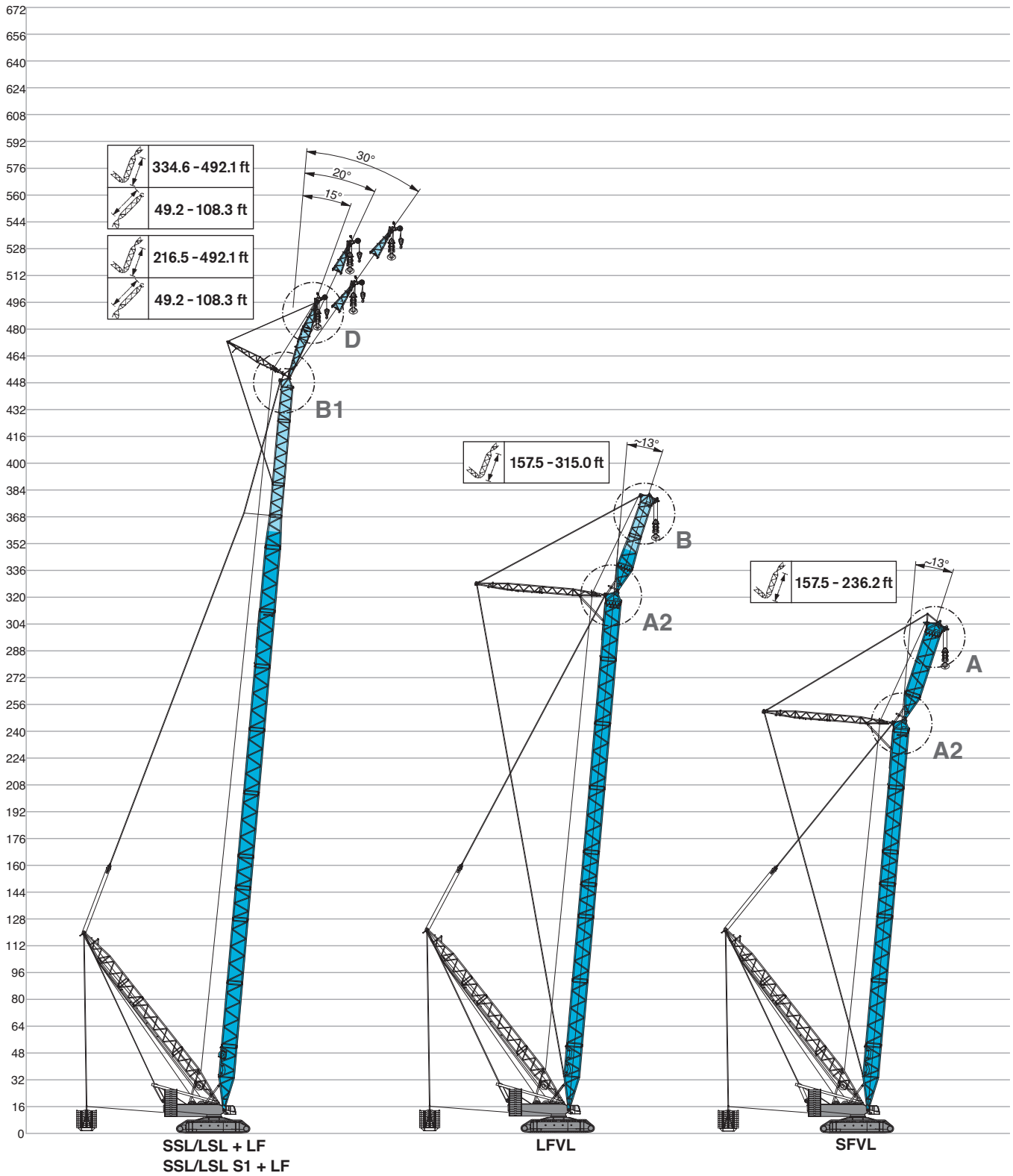

MAIN BOOM



Operation

SH, SH/LH, LH

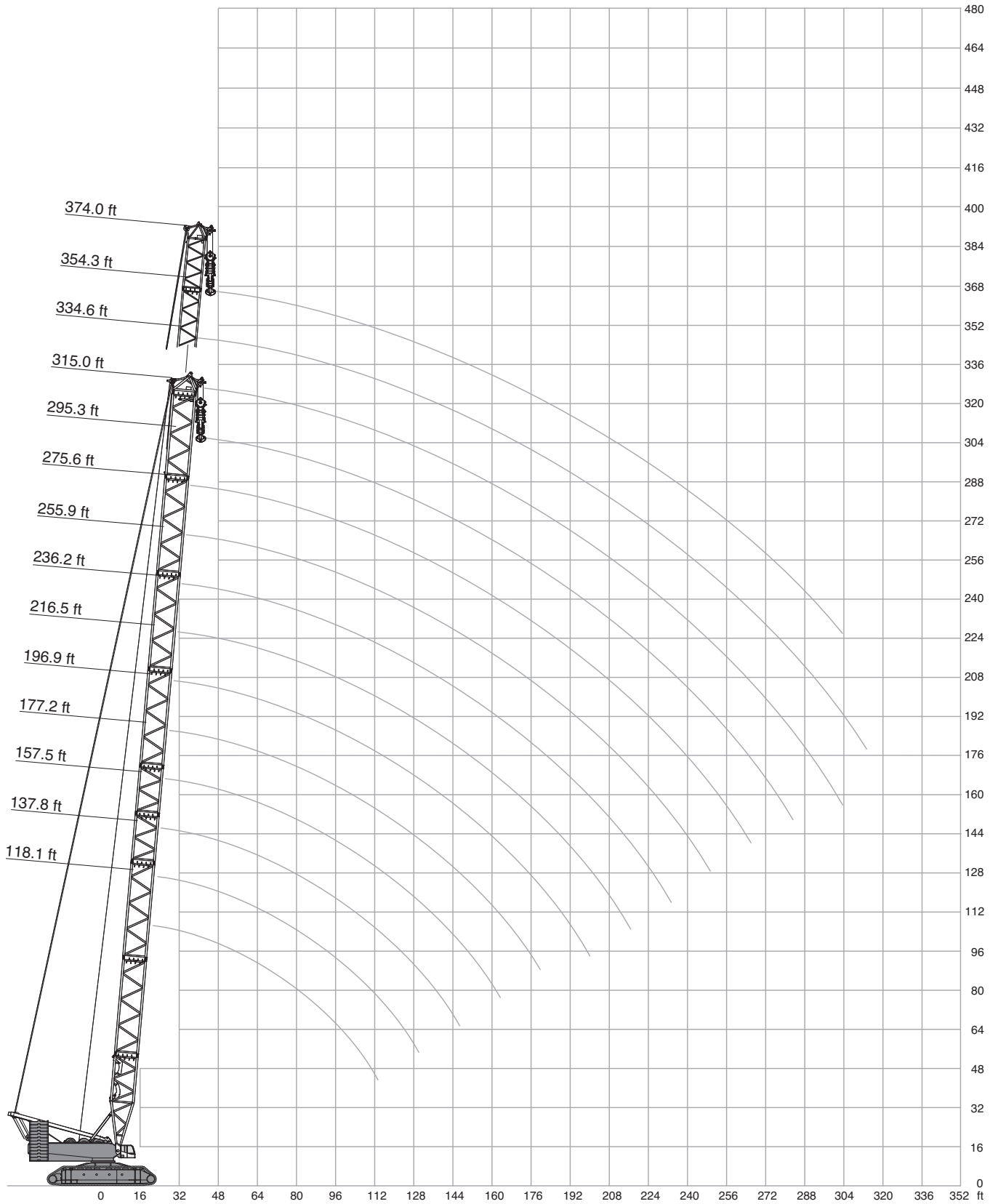

Operation

SH

+ 31.5 ft 32.2 ft/s 360° ASME B30.5													
118.1 ft 137.8 ft 157.5 ft 177.2 ft 196.9 ft 216.5 ft 236.2 ft 255.9 ft 275.6 ft 295.3 ft 315.0 ft													
ft	1,000 lb												ft
23.0	1743.9	-	-	-	-	-	-	-	-	-	-	-	23.0
26.2	1534.4	1523.4	1501.3	-	-	-	-	-	-	-	-	-	26.2
29.5	1366.9	1358.0	1305.1	1225.8	-	-	-	-	-	-	-	-	29.5
32.8	1232.4	1221.4	1153.0	1086.9	1027.4	972.2	-	-	-	-	-	-	32.8
36.1	1117.7	1089.1	1029.6	974.4	923.7	877.4	833.3	793.7	-	-	-	-	36.1
39.4	1011.9	978.9	928.1	881.8	837.8	798.1	760.6	725.3	690.0	659.2	-	-	39.4
42.7	921.5	888.5	844.4	804.7	767.2	731.9	696.7	665.8	634.9	608.5	551.2	-	42.7
45.9	844.4	811.3	773.8	738.5	703.3	674.6	643.8	615.1	586.4	562.2	535.7	-	45.9
52.5	709.9	690.0	659.2	630.5	604.1	577.6	553.4	531.3	507.1	485.0	463.0	-	52.5
59.1	588.6	584.2	571.0	549.0	524.7	504.9	482.8	463.0	443.1	423.3	405.7	-	59.1
65.6	500.4	496.0	491.6	482.8	460.8	443.1	425.5	407.9	390.2	372.6	357.1	-	65.6
72.2	434.3	427.7	423.3	418.9	410.1	394.6	377.0	361.6	346.1	330.7	315.3	-	72.2
78.7	379.2	374.8	368.2	363.8	359.4	352.7	337.3	324.1	308.6	295.4	280.0	-	78.7
85.3	337.3	330.7	326.3	321.9	317.5	313.1	304.2	291.0	277.8	264.6	251.3	-	85.3
91.9	302.0	295.4	291.0	284.4	280.0	277.8	273.4	262.4	249.1	238.1	224.9	-	91.9
98.4	273.4	266.8	260.1	255.7	251.3	246.9	244.7	238.1	224.9	215.0	202.8	-	98.4
111.5	227.1	220.5	213.8	208.3	203.9	200.6	196.2	191.8	185.2	175.3	164.2	-	111.5
124.7	-	185.2	178.6	173.1	167.6	164.2	158.7	154.3	148.8	144.4	133.4	-	124.7
128.0	-	178.6	171.4	165.9	159.8	156.0	151.0	146.1	140.5	136.1	126.8	-	128.0
137.8	-	-	152.1	146.1	138.9	134.5	129.5	124.6	118.3	113.5	107.0	-	137.8
144.4	-	-	140.0	133.4	125.7	121.3	115.7	111.3	105.6	101.2	93.9	-	144.4
150.9	-	-	-	122.9	115.6	111.0	105.2	100.5	94.6	90.1	82.2	-	150.9
160.8	-	-	-	108.9	101.3	95.9	90.4	85.3	78.8	74.4	67.1	-	160.8
164.0	-	-	-	-	96.9	91.7	86.0	80.8	74.1	69.9	62.5	-	164.0
177.2	-	-	-	-	81.6	76.2	69.4	64.4	58.0	53.1	45.4	-	177.2
190.3	-	-	-	-	-	63.1	56.2	50.6	43.7	39.0	31.6	-	190.3
196.9	-	-	-	-	-	57.1	50.0	44.3	37.5	32.6	25.1	-	196.9
203.4	-	-	-	-	-	-	44.9	38.8	32.1	27.0	19.4	-	203.4
206.7	-	-	-	-	-	-	42.3	36.2	29.4	24.2	16.5	-	206.7
213.3	-	-	-	-	-	-	37.5	31.3	24.4	19.0	-	-	213.3
216.5	-	-	-	-	-	-	-	29.0	22.0	16.5	-	-	216.5
223.1	-	-	-	-	-	-	-	24.5	17.4	-	-	-	223.1
229.7	-	-	-	-	-	-	-	20.5	-	-	-	-	229.7

551,200 lb

176,400 lb

Operation

SH/LH

+ 31.5 ft 32.2 ft/s 360° ASME B30.5												
 157.5 ft 177.2 ft 196.9 ft 216.5 ft 236.2 ft 255.9 ft 275.6 ft 295.3 ft 315.0 ft 334.6 ft 354.3 ft												
ft	1,000 lb											ft
26.2	1115.5	-	-	-	-	-	-	-	-	-	-	26.2
29.5	1115.5	1115.5	1115.5	-	-	-	-	-	-	-	-	29.5
32.8	1115.5	1104.5	1045.0	994.3	945.8	-	-	-	-	-	-	32.8
36.1	1031.8	1003.1	951.3	908.3	866.4	822.3	787.1	-	-	-	-	36.1
39.4	948.0	901.7	857.6	822.3	787.1	754.0	723.1	694.5	661.4	-	-	39.4
42.7	870.8	830.0	791.5	759.5	728.6	700.0	672.4	646.0	616.2	590.8	533.5	42.7
45.9	793.7	758.4	725.3	696.7	670.2	646.0	621.7	597.5	571.0	551.2	531.3	45.9
52.5	681.2	652.6	623.9	604.1	579.8	560.0	540.1	522.5	498.2	482.8	467.4	52.5
59.1	593.0	568.8	546.7	529.1	511.5	493.8	478.4	463.0	440.9	427.7	414.5	59.1
65.6	509.3	504.9	485.0	469.6	454.2	438.7	425.5	412.3	392.4	381.4	370.4	65.6
72.2	448.6	444.2	432.1	424.4	411.2	397.9	385.8	373.7	356.0	345.0	335.1	72.2
78.7	388.0	383.6	379.2	379.2	368.2	357.1	346.1	335.1	319.7	308.6	299.8	78.7
85.3	349.4	343.9	339.5	339.5	334.0	326.3	316.4	306.4	292.1	282.2	274.5	85.3
91.9	310.9	304.2	299.8	299.8	299.8	295.4	286.6	277.8	264.6	255.7	249.1	91.9
98.4	283.3	276.7	272.3	272.3	271.2	269.0	263.5	255.7	242.5	235.3	229.3	98.4
111.5	235.3	228.7	224.3	223.8	222.1	221.6	219.4	215.5	203.9	198.4	192.9	111.5
124.7	199.5	192.9	187.9	187.4	185.7	184.6	182.4	181.3	172.5	168.1	163.1	124.7
137.8	172.5	166.1	160.2	159.8	157.6	156.5	154.3	152.9	144.8	141.5	137.8	137.8
144.4	160.9	154.7	148.4	147.7	145.5	144.4	142.2	140.4	131.9	128.6	125.7	144.4
150.9	-	143.3	136.7	135.6	133.4	132.3	130.1	127.9	119.0	115.7	113.5	150.9
160.8	-	130.1	124.0	122.5	119.9	118.3	115.7	113.9	104.7	101.5	99.1	160.8
164.0	-	-	119.8	118.1	115.4	113.6	111.0	109.2	99.9	96.8	94.3	164.0
177.2	-	-	104.3	102.5	99.4	97.1	94.2	92.5	82.8	80.0	77.9	177.2
190.3	-	-	-	88.8	85.3	82.7	79.8	77.8	68.3	65.3	63.1	190.3
193.6	-	-	-	86.0	82.5	79.7	76.5	75.0	65.3	61.9	60.1	193.6
203.4	-	-	-	-	74.1	71.3	68.2	66.4	56.4	53.4	51.3	203.4
213.3	-	-	-	-	66.8	63.8	60.3	58.2	48.6	45.3	43.0	213.3
216.5	-	-	-	-	-	61.7	58.0	55.8	46.3	43.0	40.7	216.5
229.7	-	-	-	-	-	53.1	49.2	46.7	37.0	33.7	31.3	229.7
242.8	-	-	-	-	-	-	41.9	39.4	29.4	26.1	23.7	242.8
246.1	-	-	-	-	-	-	40.1	37.6	27.6	24.2	21.8	246.1
255.9	-	-	-	-	-	-	-	32.6	22.7	19.1	16.7	255.9
262.5	-	-	-	-	-	-	-	29.5	19.6	15.9	13.5	262.5
265.7	-	-	-	-	-	-	-	-	18.1	14.4	11.9	265.7
269.0	-	-	-	-	-	-	-	-	16.5	12.8	-	269.0
272.3	-	-	-	-	-	-	-	-	15.2	11.5	-	272.3
278.9	-	-	-	-	-	-	-	-	12.6	-	-	278.9

463,000 lb 551,200 lb
 88,200 lb 176,400 lb

Operation

LH

+ 31.5 ft 32.2 ft/s 360° ASME B30.5														
137.8 ft 157.5 ft 177.2 ft 196.9 ft 216.5 ft 236.2 ft 255.9 ft 275.6 ft 295.3 ft 315.0 ft 334.6 ft 354.3 ft 374.0 ft														
ft	1,000 lb													ft
26.2	1115.5	1115.5	-	-	-	-	-	-	-	-	-	-	-	26.2
29.5	1115.5	1115.5	1115.5	1086.9	-	-	-	-	-	-	-	-	-	29.5
32.8	1115.5	1115.5	1113.3	1058.2	950.2	793.7	-	-	-	-	-	-	-	32.8
36.1	1058.2	1035.1	1011.9	965.6	892.9	780.4	634.9	568.8	-	-	-	-	-	36.1
39.4	1000.9	954.6	910.5	873.0	835.6	767.2	634.9	568.8	509.3	412.3	-	-	-	39.4
42.7	917.1	877.4	840.0	805.8	772.7	725.3	625.0	563.3	504.9	412.3	368.2	315.3	-	42.7
45.9	833.3	800.3	769.4	738.5	709.9	683.4	615.1	557.8	500.4	412.3	368.2	315.3	266.8	45.9
52.5	712.1	687.8	663.6	639.3	617.3	595.2	573.2	537.9	485.0	399.0	363.8	310.9	266.8	52.5
59.1	606.3	601.9	579.8	562.2	542.3	526.9	507.1	491.6	467.4	385.8	354.9	302.0	257.9	59.1
65.6	518.1	515.9	513.7	500.4	485.0	469.6	451.9	440.9	425.5	372.6	343.9	295.4	249.1	65.6
72.2	457.5	455.3	453.1	446.4	438.7	426.6	411.2	401.2	388.0	357.1	335.1	286.6	241.4	72.2
78.7	396.8	394.6	392.4	392.4	392.4	383.6	370.4	361.6	350.5	341.7	326.3	277.8	233.7	78.7
85.3	357.1	356.0	352.7	352.7	352.7	347.2	339.5	331.8	321.9	314.2	302.0	272.3	227.1	85.3
91.9	317.5	317.5	313.1	313.1	313.1	310.9	308.6	302.0	293.2	286.6	277.8	266.8	220.5	91.9
98.4	289.9	289.9	285.5	285.5	284.4	283.3	281.1	276.7	271.2	265.7	256.8	248.0	216.1	98.4
111.5	242.5	241.4	238.1	237.5	235.9	235.3	232.6	231.5	229.3	226.0	219.9	213.8	201.7	111.5
124.7	208.0	205.6	202.8	201.7	200.1	199.0	195.7	195.7	193.5	191.3	187.9	184.6	179.1	124.7
128.0	200.6	198.1	195.1	194.0	192.1	191.0	187.7	187.7	185.5	183.3	180.0	177.7	172.8	128.0
137.8	-	179.1	176.0	174.5	172.3	171.2	167.6	167.6	165.3	163.1	159.8	158.7	154.3	137.8
144.4	-	167.6	164.6	162.8	160.6	159.5	155.4	155.4	153.2	151.0	147.7	146.6	142.2	144.4
150.9	-	-	153.2	151.0	148.8	147.7	143.3	143.3	141.1	138.9	135.6	134.5	130.1	150.9
160.8	-	-	140.0	138.3	135.6	134.5	130.1	130.1	127.3	125.1	121.8	120.2	116.0	160.8
164.0	-	-	-	134.1	131.2	130.1	125.7	125.7	122.7	120.5	117.2	115.4	111.3	164.0
177.2	-	-	-	119.0	116.2	114.6	110.1	109.7	106.6	104.3	100.7	98.5	94.4	177.2
190.3	-	-	-	-	103.8	101.4	96.6	95.5	92.6	90.2	86.0	83.8	79.6	190.3
193.6	-	-	-	-	101.0	98.7	93.8	92.6	89.7	87.3	83.0	80.7	76.7	193.6
203.4	-	-	-	-	-	90.7	85.4	84.1	81.1	78.7	74.1	71.8	68.0	203.4
213.3	-	-	-	-	-	83.1	77.7	76.2	73.0	70.3	66.4	64.0	59.7	213.3
216.5	-	-	-	-	-	-	75.5	73.9	70.5	68.1	64.1	61.7	57.2	216.5
229.7	-	-	-	-	-	-	67.0	65.0	61.7	59.1	54.7	52.2	48.1	229.7
242.8	-	-	-	-	-	-	-	57.8	54.4	51.5	47.1	44.8	40.4	242.8
246.1	-	-	-	-	-	-	-	56.0	52.5	49.6	45.2	42.9	38.5	246.1
255.9	-	-	-	-	-	-	-	-	47.4	44.8	40.3	37.8	33.3	255.9
262.5	-	-	-	-	-	-	-	-	44.5	41.8	37.3	34.7	30.0	262.5
269.0	-	-	-	-	-	-	-	-	-	38.8	34.2	31.5	27.1	269.0
278.9	-	-	-	-	-	-	-	-	-	34.8	30.2	27.4	23.1	278.9
282.2	-	-	-	-	-	-	-	-	-	-	28.9	26.2	21.8	282.2
295.3	-	-	-	-	-	-	-	-	-	-	24.4	21.7	17.0	295.3
298.6	-	-	-	-	-	-	-	-	-	-	23.4	20.6	15.9	298.6
308.4	-	-	-	-	-	-	-	-	-	-	-	17.4	12.6	308.4
311.7	-	-	-	-	-	-	-	-	-	-	-	16.4	11.7	311.7
315.0	-	-	-	-	-	-	-	-	-	-	-	15.4	-	315.0

	286,600 lb	374,800 lb	463,000 lb	551,200 lb
	0 lb	0 lb	88,200 lb	176,400 lb

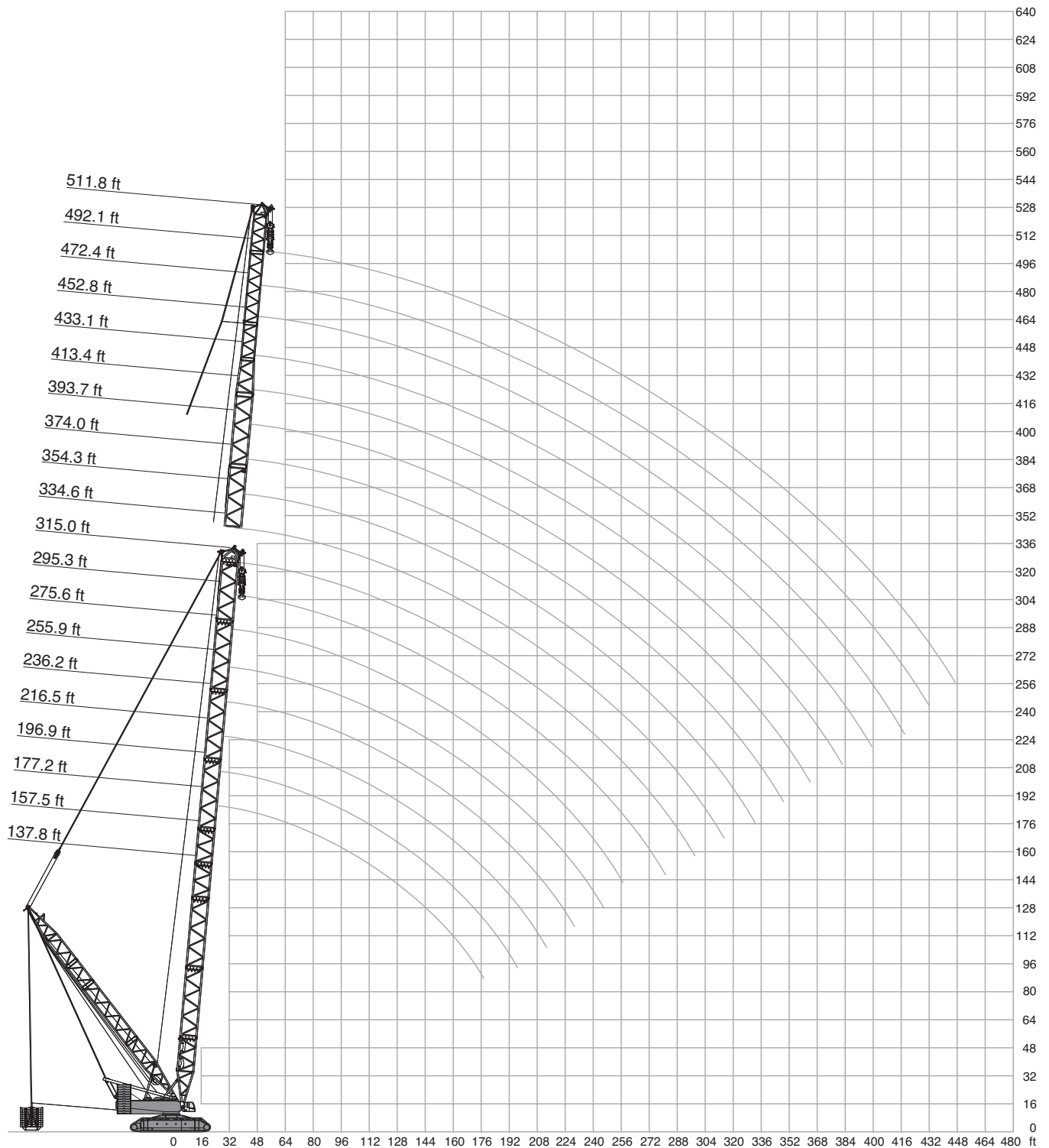

374,800 – 551,200 lb +
 0 – 176,400 lb
 49.2–98.4 ft
 31.5 ft
 32.2 ft/s 360° ASME B30.5

137.8 ft		157.5 ft		177.2 ft		196.9 ft						
0 lb		0 – 992,100 lb		0 lb		0 – 992,100 lb		0 lb		0 – 992,100 lb		
49.2 – 78.7 ft		78.7 – 98.4 ft		49.2 – 78.7 ft		78.7 – 98.4 ft		49.2 – 78.7 ft		78.7 – 98.4 ft		
ft	1,000 lb											ft
26.2	1677.7	2755.8	2755.8	1668.9	2614.7	2614.7	-	-	-	-	-	26.2
29.5	1494.7	2747.0	2755.8	1485.9	2614.7	2614.7	1422.0	2286.2	2286.2	-	-	29.5
32.8	1327.2	2740.3	2742.6	1327.2	2614.7	2614.7	1263.2	2286.2	2286.2	1194.9	2114.2	32.8
39.4	1036.2	2484.6	2683.0	1031.8	2475.8	2594.8	1029.6	2286.2	2286.2	981.1	2114.2	39.4
45.9	842.2	2178.2	2489.0	835.6	2169.4	2482.4	833.3	2162.7	2286.2	826.7	2114.2	45.9
52.5	725.3	1907.0	2184.8	696.7	1898.2	2178.2	692.3	1891.6	2169.4	690.0	1885.0	52.5
59.1	619.5	1693.2	1867.3	612.9	1684.3	1933.5	588.6	1677.7	1926.8	586.4	1671.1	59.1
65.6	537.9	1521.2	1620.4	531.3	1512.4	1737.2	526.9	1505.8	1730.6	504.9	1499.1	65.6
72.2	471.8	1377.9	1422.0	465.2	1371.3	1534.4	460.8	1364.7	1569.7	456.4	1358.0	72.2
78.7	418.9	1252.2	1256.6	412.3	1252.2	1364.7	405.7	1245.6	1435.2	401.2	1239.0	78.7
85.3	374.8	1113.3	1119.9	368.2	1150.8	1221.4	361.6	1144.2	1289.7	357.1	1137.6	85.3
91.9	337.3	994.3	1000.9	330.7	1064.8	1097.9	324.1	1058.2	1166.2	317.5	1051.6	91.9
98.4	306.4	917.1	897.3	297.6	985.5	992.1	291.0	983.3	1058.2	286.6	974.4	98.4
111.5	253.5	749.6	723.1	246.9	811.3	815.7	240.3	857.6	881.8	233.7	851.0	111.5
124.7	216.1	628.3	575.4	207.2	694.5	672.4	200.6	736.3	740.8	194.0	751.8	124.7
128.0	207.2	593.0	540.1	199.0	663.6	641.5	192.4	705.5	709.9	185.2	730.8	128.0
137.8	-	-	-	176.9	575.4	552.3	169.8	620.6	625.0	162.0	663.6	137.8
144.4	-	-	-	163.1	522.5	493.8	155.4	577.6	571.0	147.7	617.3	144.4
150.9	-	-	-	-	-	-	143.9	536.8	522.5	136.1	572.1	150.9
160.8	-	-	-	-	-	-	127.9	471.8	449.7	119.8	506.5	160.8
164.0	-	-	-	-	-	-	-	-	-	115.1	491.6	164.0
177.2	-	-	-	-	-	-	-	-	-	97.2	429.9	177.2

216.5 ft		236.2 ft		255.9 ft								
0 lb		0 – 992,100 lb		0 lb		0 – 992,100 lb		0 lb		0 – 992,100 lb		
49.2 – 78.7 ft		78.7 – 98.4 ft		49.2 – 78.7 ft		78.7 – 98.4 ft		49.2 – 78.7 ft		78.7 – 98.4 ft		
ft	1,000 lb											ft
32.8	1133.2	1854.1	1854.1	-	-	-	-	-	-	-	-	32.8
36.1	1025.2	1854.1	1854.1	976.6	1675.5	1675.5	930.4	1492.5	1496.9	-	-	36.1
39.4	934.8	1854.1	1854.1	890.7	1675.5	1675.5	853.2	1492.5	1496.9	-	-	39.4
45.9	791.5	1854.1	1854.1	756.2	1675.5	1675.5	725.3	1492.5	1496.9	-	-	45.9
52.5	683.4	1854.1	1854.1	654.8	1675.5	1675.5	628.3	1492.5	1496.9	-	-	52.5
59.1	584.2	1666.7	1854.1	573.2	1651.3	1675.5	551.2	1492.5	1496.9	-	-	59.1
65.6	502.7	1494.7	1719.6	500.4	1488.1	1675.5	489.4	1468.3	1496.9	-	-	65.6
72.2	454.2	1351.4	1558.7	434.3	1347.0	1552.1	432.1	1340.4	1496.9	-	-	72.2
78.7	399.0	1234.6	1422.0	396.8	1228.0	1415.4	379.2	1221.4	1411.0	-	-	78.7
85.3	352.7	1133.2	1307.3	350.5	1126.6	1300.7	346.1	1122.2	1296.3	-	-	85.3
91.9	315.3	1045.0	1208.1	310.9	1040.6	1201.5	308.6	1034.0	1197.1	-	-	91.9
98.4	282.2	970.0	1122.2	277.8	963.4	1115.5	273.4	959.0	1111.1	-	-	98.4
111.5	229.3	846.6	959.0	224.9	840.0	974.4	220.5	833.3	967.8	-	-	111.5
124.7	189.6	747.4	820.1	184.1	740.8	840.0	179.7	734.1	848.8	-	-	124.7
137.8	157.6	669.1	711.0	152.7	662.5	731.9	147.2	655.9	743.0	-	-	137.8
150.9	131.2	599.7	615.1	125.7	595.2	638.2	120.4	589.7	652.6	-	-	150.9
164.0	109.6	528.0	532.4	103.6	537.9	558.9	98.3	533.5	575.4	-	-	164.0
177.2	91.8	454.2	458.6	85.2	481.7	489.4	79.6	483.9	508.2	-	-	177.2
190.3	76.6	397.9	390.2	69.4	422.2	425.5	63.6	438.7	447.5	-	-	190.3
196.9	69.7	374.8	357.1	62.2	392.4	394.6	56.2	416.7	418.9	-	-	196.9
203.4	-	-	-	56.1	366.0	367.1	49.9	390.2	393.5	-	-	203.4
213.3	-	-	-	47.2	341.7	324.1	41.0	352.7	356.0	-	-	213.3
216.5	-	-	-	-	-	-	38.3	340.2	343.9	-	-	216.5
229.7	-	-	-	-	-	-	28.0	306.4	295.4	-	-	229.7

Lifting capacities > 2205,000 lb only with special equipment

	0 lb	352,800 lb	529,200 lb	705,600 lb	882,000 lb	992,100 lb
--	------	------------	------------	------------	------------	------------

374,800 - 551,200 lb +
 0 - 176,400 lb
 49.2 - 98.4 ft
 31.5 ft
 32.2 ft/s
 360° ASME B30.5

275.6 ft | 295.3 ft | 315.0 ft
 0 lb | 0 - 992,100 lb | 0 lb | 0 - 992,100 lb | 0 lb | 0 - 992,100 lb
 49.2 - 78.7 ft | 78.7 - 98.4 ft | 49.2 - 78.7 ft | 78.7 - 98.4 ft | 49.2 - 78.7 ft | 78.7 - 98.4 ft

ft	1,000 lb										ft
39.4	813.5	1377.9	1331.6	778.2	1232.4	1190.5	-	-	-	-	39.4
42.7	749.6	1377.9	1331.6	718.7	1232.4	1190.5	687.8	1097.9	1067.0	1067.0	42.7
45.9	694.5	1377.9	1331.6	665.8	1232.4	1190.5	637.1	1097.9	1067.0	1067.0	45.9
52.5	601.9	1377.9	1331.6	579.8	1232.4	1190.5	555.6	1097.9	1067.0	1067.0	52.5
59.1	529.1	1358.0	1331.6	509.3	1232.4	1190.5	487.2	1097.9	1067.0	1067.0	59.1
65.6	469.6	1331.6	1331.6	451.9	1212.5	1190.5	432.1	1097.9	1067.0	1067.0	65.6
72.2	418.9	1311.8	1331.6	403.4	1188.3	1190.5	385.8	1080.3	1067.0	1067.0	72.2
78.7	374.8	1214.7	1331.6	361.6	1179.5	1190.5	346.1	1062.6	1067.0	1067.0	78.7
85.3	328.5	1113.3	1289.7	326.3	1108.9	1183.9	313.1	1053.8	1067.0	1067.0	85.3
91.9	302.0	1027.4	1190.5	286.6	1022.9	1164.0	280.0	1014.1	1062.6	1062.6	91.9
98.4	269.0	952.4	1104.5	264.6	945.8	1097.9	255.7	939.2	1053.8	1053.8	98.4
111.5	215.0	826.7	961.2	211.6	822.3	956.8	203.9	813.5	948.0	948.0	111.5
124.7	173.1	727.5	846.6	169.8	723.1	844.4	160.9	714.3	831.1	831.1	124.7
137.8	140.5	649.3	746.3	136.1	644.9	745.2	128.4	636.0	734.1	734.1	137.8
150.9	113.8	582.0	658.1	109.1	577.6	660.3	101.2	568.8	652.6	652.6	150.9
164.0	91.6	525.8	583.1	86.6	521.4	587.5	78.5	512.6	582.0	582.0	164.0
177.2	72.6	478.4	518.1	67.5	474.0	523.6	59.3	465.2	521.4	521.4	177.2
190.3	56.4	436.5	460.8	51.1	432.1	468.5	43.0	423.3	468.5	468.5	190.3
203.4	42.5	399.0	409.0	37.1	395.7	420.0	29.0	386.9	421.1	421.1	203.4
216.5	30.6	359.4	361.6	25.0	363.8	374.8	16.5	354.9	378.1	378.1	216.5
226.4	22.7	326.3	328.5	16.8	339.5	342.8	-	335.1	347.8	347.8	226.4
229.7	20.3	315.3	317.5	-	330.0	332.9	-	328.5	338.4	338.4	229.7
236.2	15.4	293.2	295.4	-	310.9	313.1	-	315.3	319.7	319.7	236.2
242.8	-	278.5	274.8	-	292.1	294.3	-	298.7	302.0	302.0	242.8
246.1	-	273.4	264.6	-	282.7	284.9	-	290.5	293.2	293.2	246.1
255.9	-	-	-	-	254.6	256.8	-	265.7	267.9	267.9	255.9
262.5	-	-	-	-	244.7	238.1	-	249.1	251.3	251.3	262.5
269.0	-	-	-	-	-	-	-	233.7	235.9	235.9	269.0
278.9	-	-	-	-	-	-	-	216.1	212.7	212.7	278.9

0 lb |
 352,800 lb |
 529,200 lb |
 705,600 lb |
 882,000 lb |
 992,100 lb

Operation

SSL/LSL S1

374,800 – 551,200 lb + 0 – 176,400 lb 49.2–98.4 ft 31.5 ft 32.2 ft/s 360° ASME B30.5

216.5 ft		236.2 ft		255.9 ft		275.6 ft							
SSL/LSL S1		SSL/LSL S1		SSL/LSL S1		SSL/LSL S1							
0 lb 0 – 992,100 lb		0 lb 0 – 992,100 lb		0 lb 0 – 992,100 lb		0 lb 0 – 992,100 lb							
49.2 – 78.7 ft 78.7 – 98.4 ft		49.2 – 78.7 ft 78.7 – 98.4 ft		49.2 – 78.7 ft 78.7 – 98.4 ft		49.2 – 78.7 ft 78.7 – 98.4 ft							
ft	1,000 lb										ft		
32.8	1115.5	1115.5	1115.5	1089.1	1115.5	1115.5	-	-	-	-	-	32.8	
36.1	1040.6	1115.5	1115.5	989.9	1115.5	1115.5	945.8	1115.5	1115.5	901.7	1115.5	1115.5	36.1
39.4	956.8	1115.5	1115.5	912.7	1115.5	1115.5	873.0	1115.5	1115.5	834.5	1115.5	1115.5	39.4
45.9	812.4	1115.5	1115.5	777.1	1115.5	1115.5	746.3	1115.5	1115.5	715.4	1115.5	1115.5	45.9
52.5	703.3	1115.5	1115.5	674.6	1115.5	1115.5	649.3	1115.5	1115.5	622.8	1115.5	1115.5	52.5
59.1	610.7	1115.5	1115.5	594.1	1115.5	1115.5	572.1	1115.5	1115.5	549.0	1115.5	1115.5	59.1
65.6	530.2	1115.5	1115.5	521.4	1115.5	1115.5	509.3	1115.5	1115.5	488.3	1115.5	1115.5	65.6
72.2	470.3	1115.5	1115.5	461.5	1115.5	1115.5	453.4	1115.5	1115.5	438.7	1115.5	1115.5	72.2
78.7	423.3	1115.5	1115.5	414.5	1115.5	1115.5	399.0	1115.5	1115.5	394.6	1115.5	1115.5	78.7
85.3	381.4	1092.4	1115.5	372.6	1086.9	1115.5	363.8	1085.8	1111.1	359.4	1081.4	1115.5	85.3
91.9	339.5	1069.2	1115.5	330.7	1058.2	1115.5	328.5	1056.0	1106.7	324.1	1047.2	1095.7	91.9
98.4	309.7	997.6	1089.1	300.9	987.7	1115.5	297.6	984.4	1100.1	293.2	976.6	1067.0	98.4
111.5	256.8	870.8	983.3	248.0	862.0	992.1	243.6	857.6	989.9	238.7	851.0	983.3	111.5
124.7	215.5	771.6	844.4	206.7	762.8	857.6	202.8	758.4	870.8	196.8	751.8	868.6	124.7
137.8	183.4	690.8	731.9	174.5	682.7	749.6	170.9	679.0	762.8	164.2	672.4	767.2	137.8
150.9	155.4	617.3	637.1	146.6	610.7	657.0	142.2	608.5	674.6	135.6	601.9	679.0	150.9
164.0	134.8	548.2	555.6	126.0	554.8	577.6	121.6	552.6	597.5	114.9	547.5	604.1	164.0
177.2	116.8	479.1	480.6	107.7	498.2	507.1	103.2	502.7	529.1	96.2	498.2	540.1	177.2
190.3	101.2	423.3	414.5	91.7	440.9	445.3	86.9	458.6	469.6	79.6	454.2	482.8	190.3
193.6	97.9	414.5	396.8	88.6	427.0	431.0	83.6	446.8	456.4	76.3	445.0	470.1	193.6
203.4	-	-	-	79.2	385.1	388.0	73.9	411.5	416.7	66.4	417.4	432.1	203.4
213.3	-	-	-	70.3	359.4	346.1	64.9	375.9	378.6	57.1	388.7	395.7	213.3
216.5	-	-	-	-	-	-	62.3	363.8	366.0	54.5	378.5	383.6	216.5
229.7	-	-	-	-	-	-	52.0	324.1	317.5	43.9	337.3	339.5	229.7
242.8	-	-	-	-	-	-	-	-	-	35.1	296.7	298.9	242.8
246.1	-	-	-	-	-	-	-	-	-	32.8	291.0	288.8	246.1

	0 lb	176,400 lb	352,800 lb	529,200 lb	705,600 lb	882,000 lb	992,100 lb
--	------	------------	------------	------------	------------	------------	------------

Operation

SSL/LSL, SSL/LSL S1

374,800 – 551,200 lb + 0 – 176,400 lb 49.2–98.4 ft 31.5 ft 32.2 ft/s 360° ASME B30.5

295.3 ft		315.0 ft		334.6 ft								
SSL/LSL S1		SSL/LSL S1		SSL/LSL		SSL/LSL S1						
0 lb		0 – 992,100 lb		0 lb		0 – 992,100 lb						
49.2 – 78.7 ft		78.7 – 98.4 ft		49.2 – 78.7 ft		78.7 – 98.4 ft						
ft	1,000 lb										ft	
39.4	793.7	1115.5	1115.5	758.4	1080.3	1058.2	-	-	-	-	39.4	
42.7	734.1	1115.5	1115.5	703.3	1080.3	1058.2	679.0	992.1	959.0	965.6	948.0	42.7
45.9	685.6	1115.5	1115.5	657.0	1080.3	1058.2	634.9	992.1	959.0	965.6	948.0	45.9
52.5	598.6	1115.5	1115.5	574.3	1080.3	1058.2	555.6	992.1	959.0	965.6	948.0	52.5
59.1	528.0	1115.5	1115.5	508.2	1079.2	1058.2	491.6	992.1	959.0	965.6	948.0	59.1
65.6	470.7	1115.5	1115.5	453.1	1072.5	1058.2	438.7	992.1	959.0	965.6	948.0	65.6
72.2	424.0	1115.5	1115.5	407.1	1056.0	1058.2	394.6	975.2	959.0	954.6	948.0	72.2
78.7	381.4	1115.5	1113.3	366.0	1056.0	1058.2	354.9	972.2	959.0	954.6	948.0	78.7
85.3	345.0	1079.2	1106.7	332.9	1036.2	1056.0	324.1	954.6	959.0	945.8	948.0	85.3
91.9	308.6	1042.8	1102.3	299.8	1027.4	1053.8	293.2	952.4	959.0	945.8	948.0	91.9
98.4	283.3	972.2	1064.8	274.5	960.1	1049.4	269.0	920.4	959.0	912.7	948.0	98.4
111.5	234.8	846.6	976.6	226.0	837.8	961.2	221.0	833.3	943.6	836.7	910.5	111.5
124.7	192.9	746.3	864.2	184.1	738.5	853.2	179.1	733.0	840.0	738.5	844.4	124.7
137.8	159.8	666.5	765.0	151.0	659.2	756.2	146.6	653.3	745.2	659.2	751.8	137.8
150.9	131.2	597.5	681.2	122.4	588.6	674.6	117.9	584.2	665.8	588.6	672.4	150.9
164.0	110.0	543.1	608.5	101.3	535.7	604.1	96.3	529.8	597.5	535.7	606.3	164.0
177.2	91.1	493.8	546.7	82.5	487.2	542.3	77.1	481.3	540.1	488.0	546.7	177.2
190.3	74.3	449.7	491.6	65.7	443.1	489.4	60.2	438.7	489.4	445.3	496.0	190.3
203.4	60.9	414.5	440.9	52.3	407.9	443.1	46.8	403.4	443.1	408.6	449.7	203.4
216.5	48.8	382.1	396.8	40.2	375.5	399.0	34.7	371.1	401.2	375.5	410.1	216.5
229.7	37.9	352.7	354.9	29.3	346.1	361.6	23.8	341.7	366.0	346.1	372.6	229.7
242.8	29.1	314.5	316.7	20.4	319.7	326.3	14.6	317.0	330.7	322.6	338.8	242.8
246.1	26.9	305.0	307.2	18.1	313.1	317.5	12.3	310.9	321.9	316.7	330.3	246.1
255.9	20.8	277.8	280.0	11.9	288.8	291.0	-	291.7	299.8	299.1	306.4	255.9
262.5	17.0	262.4	262.4	-	272.3	274.5	-	279.3	284.4	286.6	291.0	262.5
269.0	-	-	-	-	255.7	257.9	-	266.8	269.0	273.4	275.6	269.0
278.9	-	-	-	-	233.7	235.9	-	245.8	248.0	252.4	254.6	278.9
282.2	-	-	-	-	-	-	-	238.8	241.0	245.4	247.7	282.2
295.3	-	-	-	-	-	-	-	210.9	213.1	217.5	219.7	295.3
298.6	-	-	-	-	-	-	-	207.2	206.1	212.7	212.7	298.6

	0 lb	176,400 lb	352,800 lb	529,200 lb	705,600 lb	882,000 lb	992,100 lb
--	------	------------	------------	------------	------------	------------	------------

Operation

SSL/LSL, SSL/LSL S1

374,800 – 551,200 lb + 0 – 176,400 lb 49.2–98.4 ft 31.5 ft 32.2 ft/s 360° ASME B30.5															
354.3 ft					374.0 ft					393.7 ft					
SSL/LSL					SSL/LSL S1					SSL/LSL			SSL/LSL S1		
0 lb					0 – 992,100 lb					0 lb			0 – 992,100 lb		
49.2 – 78.7 ft		78.7 – 98.4 ft		49.2 – 78.7 ft		78.7 – 98.4 ft		49.2 – 78.7 ft		78.7 – 98.4 ft		49.2 – 78.7 ft		78.7 – 98.4 ft	
ft	1,000 lb														
42.7	648.2	892.9	862.0	873.0	859.8	-	-	-	-	-	-	-	-	-	-
45.9	606.3	892.9	862.0	873.0	859.8	584.2	802.5	773.8	789.3	778.2	564.4	727.5	703.3	716.5	703.3
52.5	531.3	892.9	862.0	873.0	859.8	514.8	802.5	773.8	789.3	778.2	496.0	727.5	703.3	716.5	703.3
59.1	469.6	892.9	862.0	873.0	859.8	456.4	802.5	773.8	789.3	778.2	439.8	727.5	703.3	716.5	703.3
65.6	417.8	892.9	862.0	871.9	859.8	406.8	802.5	773.8	789.3	778.2	392.4	727.5	703.3	716.5	703.3
72.2	375.5	892.9	862.0	869.4	859.8	365.2	802.5	773.8	787.1	778.2	352.7	727.5	703.3	713.6	703.3
78.7	337.3	892.9	862.0	866.4	859.8	328.5	802.5	773.8	782.6	778.2	317.5	727.5	703.3	707.7	703.3
85.3	307.5	868.6	862.0	858.7	859.8	299.8	791.5	773.8	779.3	778.2	289.9	725.3	703.3	700.0	703.3
91.9	277.8	868.6	862.0	855.4	859.8	271.2	791.5	773.8	778.2	778.2	262.4	723.1	703.3	696.7	703.3
98.4	251.3	857.6	862.0	834.5	857.6	246.9	782.6	773.8	771.6	776.0	240.3	716.5	703.3	695.6	703.3
111.5	206.1	812.4	862.0	799.2	846.6	203.9	766.1	773.8	743.0	765.0	195.1	700.0	703.3	682.3	690.0
124.7	168.7	723.1	811.3	730.8	793.7	166.4	718.7	760.6	704.4	736.3	157.6	685.6	703.3	649.3	665.8
137.8	135.8	644.5	727.5	651.1	736.3	133.5	641.5	712.1	646.7	698.9	129.2	637.1	670.2	611.4	632.7
150.9	107.6	575.4	650.4	582.0	659.2	105.2	571.0	641.5	577.6	652.6	101.0	566.6	630.5	568.8	597.5
164.0	86.0	521.0	586.4	527.6	595.2	83.6	518.1	577.6	523.2	588.6	79.2	513.7	568.8	514.4	560.0
177.2	66.7	472.5	529.1	479.1	537.9	64.3	470.3	524.7	474.7	533.5	59.9	465.9	515.9	465.9	520.3
190.3	49.8	429.9	478.4	436.5	489.4	47.4	427.7	476.2	432.1	485.0	43.0	423.3	469.6	423.3	474.0
203.4	36.3	394.6	434.3	402.7	445.3	33.9	392.4	434.3	396.8	440.9	29.5	388.0	427.7	389.5	432.1
216.5	24.1	362.3	396.8	370.4	405.7	21.5	359.8	394.6	365.2	403.4	17.0	354.9	390.2	357.6	394.6
223.1	18.7	347.6	378.1	354.9	388.0	15.8	344.8	377.0	351.3	385.8	11.2	339.5	373.3	342.6	377.0
226.4	15.9	340.2	368.7	347.2	379.2	13.0	337.3	368.2	344.3	377.0	-	332.9	365.2	335.1	369.3
229.7	13.2	332.9	359.4	339.5	370.4	-	330.7	361.6	337.3	368.2	-	326.3	357.1	328.5	361.6
242.8	-	309.4	328.5	315.3	337.3	-	307.2	330.7	312.0	337.3	-	302.8	327.8	305.0	332.2
255.9	-	286.6	298.4	293.9	307.2	-	285.1	301.3	289.5	307.9	-	280.7	299.8	282.2	304.2
269.0	-	264.6	269.0	273.4	277.8	-	264.6	273.4	269.0	280.0	-	260.1	273.4	260.1	277.8
282.2	-	239.6	242.5	248.4	251.3	-	245.4	248.4	251.3	255.0	-	241.0	249.9	242.5	254.3
295.3	-	215.0	217.2	223.8	226.0	-	224.1	224.9	230.8	231.5	-	222.7	227.4	224.9	231.5
308.4	-	190.7	192.9	199.5	201.7	-	200.6	202.8	207.2	209.4	-	205.0	206.1	207.2	209.4
315.0	-	183.0	179.7	189.6	189.6	-	189.6	191.4	195.8	198.0	-	194.4	196.2	197.3	199.2
321.5	-	-	-	-	-	-	178.6	180.0	184.5	186.7	-	184.3	186.3	186.8	188.9
331.4	-	-	-	-	-	-	165.3	164.2	170.9	169.8	-	169.2	171.4	171.4	172.5
334.6	-	-	-	-	-	-	-	-	-	-	-	164.2	166.4	166.4	166.4
347.8	-	-	-	-	-	-	-	-	-	-	-	148.8	146.6	149.9	143.3

	0 lb	176,400 lb	352,800 lb	529,200 lb	705,600 lb	882,000 lb	992,100 lb
--	------	------------	------------	------------	------------	------------	------------

Operation

SSL/LSL, SSL/LSL S1

374,800 – 551,200 lb + 0 – 176,400 lb 49.2–98.4 ft 31.5 ft 32.2 ft/s 360° ASME B30.5																			
413.4 ft					433.1 ft					452.8 ft									
SSL/LSL					SSL/LSL S1					SSL/LSL					SSL/LSL S1				
0 lb					0 – 992,100 lb					0 lb					0 – 992,100 lb				
49.2 – 78.7 ft					78.7 – 98.4 ft					49.2 – 78.7 ft					78.7 – 98.4 ft				
1,000 lb																			
49.2	509.3	652.6	632.7	634.9	630.5	496.0	586.4	571.0	577.6	573.2	-	-	-	-					
52.5	480.6	652.6	632.7	634.9	630.5	467.4	586.4	571.0	577.6	573.2	451.9	526.9	509.3	529.1	522.5				
59.1	426.6	652.6	632.7	634.9	630.5	415.6	586.4	571.0	577.6	573.2	402.3	526.9	507.1	526.9	522.5				
65.6	381.4	652.6	632.7	634.9	630.5	371.5	586.4	571.0	577.6	573.2	359.4	525.8	504.9	526.9	522.5				
72.2	343.9	652.6	632.7	634.9	630.5	333.6	586.4	571.0	577.6	573.2	323.3	524.7	504.9	526.2	522.5				
78.7	308.6	652.6	632.7	634.9	630.5	299.8	586.4	571.0	577.6	573.2	291.0	524.7	502.7	524.7	522.5				
85.3	281.1	652.6	632.7	634.9	630.5	273.4	586.4	571.0	577.6	573.2	265.7	523.6	498.2	524.7	522.5				
91.9	253.5	652.6	632.7	634.9	628.3	246.9	586.4	571.0	577.6	571.0	240.3	522.5	496.0	524.7	520.3				
98.4	232.6	647.1	632.7	634.9	628.3	226.5	585.3	568.8	577.6	571.0	219.9	519.2	491.6	524.7	520.3				
111.5	190.1	634.9	632.7	631.6	628.3	186.8	578.7	562.2	577.6	571.0	181.9	511.5	482.8	524.7	518.1				
124.7	154.9	621.7	626.1	610.7	626.1	153.2	561.1	555.6	563.3	571.0	146.1	493.8	474.0	520.3	515.9				
137.8	126.8	592.3	610.7	589.4	610.7	124.8	541.6	546.7	548.2	562.2	116.3	474.0	460.8	505.6	513.7				
150.9	98.1	564.4	588.6	568.8	593.0	96.6	518.1	537.9	537.9	549.0	93.3	454.2	449.7	493.8	504.9				
164.0	76.4	510.0	560.0	515.9	573.2	74.8	493.1	526.9	499.7	537.9	71.5	438.0	438.7	480.6	498.2				
177.2	57.0	461.5	507.1	468.1	520.3	55.4	459.3	500.4	459.3	507.1	52.1	426.2	425.5	452.7	489.4				
190.3	40.1	418.9	463.0	425.5	474.0	38.4	416.7	456.4	416.7	460.8	35.1	414.5	412.3	410.1	449.7				
203.4	26.5	383.6	423.3	390.2	432.1	24.8	382.9	416.7	382.9	421.1	21.5	379.2	399.0	376.3	410.1				
213.3	16.6	359.4	395.2	365.5	405.7	15.1	358.3	391.9	358.3	394.6	11.7	352.7	383.6	352.0	384.7				
216.5	13.7	352.7	385.8	358.5	396.8	12.1	350.5	383.6	350.5	385.8	-	345.7	377.0	344.7	377.0				
229.7	-	324.1	354.9	328.5	363.8	-	321.9	350.5	321.9	354.9	-	317.5	346.1	315.3	346.1				
242.8	-	299.1	325.5	305.0	334.4	-	298.4	324.1	296.9	327.0	-	293.9	319.7	290.3	318.2				
255.9	-	276.3	298.4	282.9	307.2	-	275.6	298.4	274.1	300.6	-	271.9	293.9	267.5	292.5				
269.0	-	255.7	273.4	262.4	282.2	-	253.5	273.4	253.5	275.6	-	251.3	269.0	246.9	269.0				
282.2	-	238.1	251.3	243.2	258.7	-	235.9	251.3	235.9	253.5	-	233.7	248.4	229.3	246.9				
295.3	-	221.8	230.0	226.3	237.0	-	219.4	230.8	219.4	232.6	-	216.1	228.9	212.7	227.1				
308.4	-	206.1	209.4	211.6	217.2	-	205.0	211.6	203.9	212.7	-	200.6	210.5	197.3	208.3				
321.5	-	188.5	190.1	195.7	197.8	-	190.3	193.3	190.0	194.4	-	187.4	193.6	183.4	190.7				
334.6	-	170.5	171.6	177.1	178.6	-	174.5	175.6	174.5	176.4	-	173.8	177.1	169.4	173.4				
347.8	-	152.1	153.2	158.7	159.8	-	157.6	158.7	157.6	158.7	-	159.8	160.9	155.4	156.5				
360.9	-	135.8	135.6	140.2	142.2	-	141.5	142.6	140.7	142.6	-	144.4	145.5	140.0	141.1				
364.2	-	133.4	131.2	137.8	137.8	-	137.4	138.5	136.5	138.5	-	140.5	141.6	136.1	137.2				
374.0	-	-	-	-	-	-	125.4	126.5	124.3	126.1	-	129.2	130.4	124.6	126.3				
383.9	-	-	-	-	-	-	117.9	114.6	116.8	113.5	-	117.9	119.4	113.8	115.1				
387.1	-	-	-	-	-	-	-	-	-	-	-	114.6	115.7	110.2	111.3				
400.3	-	-	-	-	-	-	-	-	-	-	-	104.9	102.1	100.1	97.0				

	0 lb	176,400 lb	352,800 lb	529,200 lb	705,600 lb	882,000 lb	992,100 lb
--	------	------------	------------	------------	------------	------------	------------

Operation

SSL/LSL, SSL/LSL S1

374,800 – 551,200 lb + 0 – 176,400 lb 49.2-98.4 ft 31.5 ft 32.2 ft/s 360° ASME B30.5

		472.4 ft					492.1 ft					511.8 ft					
		SSL/LSL		SSL/LSL S1			SSL/LSL		SSL/LSL S1			SSL/LSL S1					
		0 lb		0 – 992,100 lb			0 lb		0 – 992,100 lb			0 lb		0 – 992,100 lb			
		49.2 – 78.7 ft		78.7 – 98.4 ft	49.2 – 78.7 ft	78.7 – 98.4 ft	49.2 – 78.7 ft		78.7 – 98.4 ft	49.2 – 78.7 ft	78.7 – 98.4 ft	49.2 – 78.7 ft		78.7 – 98.4 ft			
ft		1,000 lb													ft		
55.8	412.3	460.8	447.5	482.8	474.0	377.0	405.7	394.6	438.7	429.9	-	-	-	55.8			
59.1	390.2	459.7	445.3	482.8	474.0	359.4	404.5	392.4	438.7	429.9	341.7	396.8	390.2	59.1			
65.6	349.4	457.5	443.1	482.8	474.0	339.5	401.2	390.2	438.7	429.9	306.4	396.8	390.2	65.6			
72.2	315.3	454.2	438.7	482.8	474.0	306.4	396.8	385.8	438.7	429.9	273.4	396.8	390.2	72.2			
78.7	284.4	449.7	436.5	482.8	474.0	275.6	392.4	381.4	438.7	429.9	242.5	396.8	390.2	78.7			
85.3	259.0	446.4	429.9	482.8	474.0	251.3	388.0	377.0	438.7	429.9	219.4	396.8	388.0	85.3			
91.9	233.7	443.1	425.5	482.8	471.8	227.1	383.6	370.4	438.7	427.7	196.2	396.8	388.0	91.9			
98.4	214.4	438.7	421.1	481.7	471.8	207.8	379.2	363.8	437.6	427.7	177.5	394.6	388.0	98.4			
111.5	178.6	428.8	407.9	479.5	471.8	172.5	368.2	352.7	434.3	427.7	143.3	392.4	385.8	111.5			
124.7	143.9	416.7	396.8	477.3	469.6	139.4	354.9	339.5	433.2	425.5	114.9	391.3	383.6	124.7			
137.8	114.3	404.2	381.4	465.9	465.2	111.0	341.7	326.3	426.2	423.3	89.8	386.5	381.4	137.8			
150.9	91.7	392.4	368.2	454.2	463.0	88.2	328.5	313.1	416.7	418.9	65.7	379.2	379.2	150.9			
164.0	69.8	367.4	354.9	446.8	456.4	66.3	316.7	299.8	409.3	414.5	48.1	371.8	377.0	164.0			
177.2	50.3	350.5	339.5	430.6	447.5	46.8	301.3	286.6	402.7	407.9	30.5	363.8	370.4	177.2			
190.3	33.3	337.3	328.5	405.7	438.7	29.8	286.6	273.4	396.8	403.4	13.0	359.4	366.0	190.3			
203.4	19.8	326.7	315.3	370.4	403.4	15.8	277.0	262.4	362.7	390.2	-	346.1	359.4	203.4			
206.7	16.4	324.1	313.1	361.6	395.2	12.3	274.1	260.1	354.4	382.5	-	342.8	356.0	206.7			
210.0	13.0	319.7	310.9	352.7	386.9	-	271.2	257.2	346.1	374.8	-	339.5	352.7	210.0			
216.5	-	312.3	304.2	338.8	370.4	-	261.6	251.3	332.2	359.4	-	324.8	346.1	216.5			
229.7	-	302.0	295.4	310.9	339.5	-	251.3	242.5	304.2	328.5	-	295.4	317.5	229.7			
242.8	-	287.3	285.1	285.9	313.1	-	241.0	233.7	279.3	302.0	-	271.9	292.5	242.8			
255.9	-	269.7	274.1	263.1	288.1	-	230.8	226.3	256.5	277.8	-	249.1	268.2	255.9			
269.0	-	249.1	262.4	242.5	264.6	-	220.5	220.5	235.9	255.7	-	229.3	244.7	269.0			
282.2	-	231.5	244.7	222.7	242.5	-	213.4	214.6	218.3	235.2	-	210.9	225.6	282.2			
295.3	-	214.3	227.6	208.0	222.7	-	205.4	208.6	201.4	216.1	-	193.6	207.2	295.3			
308.4	-	198.4	210.5	191.8	205.0	-	195.1	202.8	185.2	198.4	-	177.5	189.6	308.4			
321.5	-	185.2	193.6	177.8	187.4	-	181.1	189.6	171.2	181.5	-	164.2	173.4	321.5			
334.6	-	172.7	177.5	165.0	170.9	-	168.3	175.6	158.4	165.3	-	151.0	158.0	334.6			
347.8	-	160.9	162.0	153.2	155.4	-	156.5	160.9	146.6	149.9	-	138.9	143.3	347.8			
360.9	-	146.2	147.3	138.9	140.7	-	144.8	147.0	134.1	136.0	-	127.9	130.1	360.9			
374.0	-	132.3	133.4	124.9	126.2	-	132.3	133.4	121.4	122.5	-	116.2	117.2	374.0			
387.1	-	119.0	120.2	110.2	111.3	-	119.0	120.2	108.5	109.6	-	103.8	104.7	387.1			
400.3	-	105.8	107.4	96.9	98.5	-	107.3	108.7	95.7	96.8	-	91.6	92.5	400.3			
413.4	-	95.4	94.1	86.4	84.8	-	95.4	96.7	83.0	84.1	-	79.7	80.6	413.4			
416.7	-	93.7	90.8	84.7	81.4	-	92.4	93.7	79.8	81.0	-	76.7	77.7	416.7			
426.5	-	-	-	-	-	-	84.7	84.7	72.5	71.7	-	67.9	69.0	426.5			
433.1	-	-	-	-	-	-	81.6	78.7	69.9	65.5	-	64.1	63.3	433.1			
439.6	-	-	-	-	-	-	-	-	-	-	-	61.3	57.5	439.6			
449.5	-	-	-	-	-	-	-	-	-	-	-	54.9	48.9	449.5			

	0 lb	176,400 lb	352,800 lb	529,200 lb	705,600 lb	882,000 lb	992,100 lb
--	------	------------	------------	------------	------------	------------	------------

FIXED FLY JIB



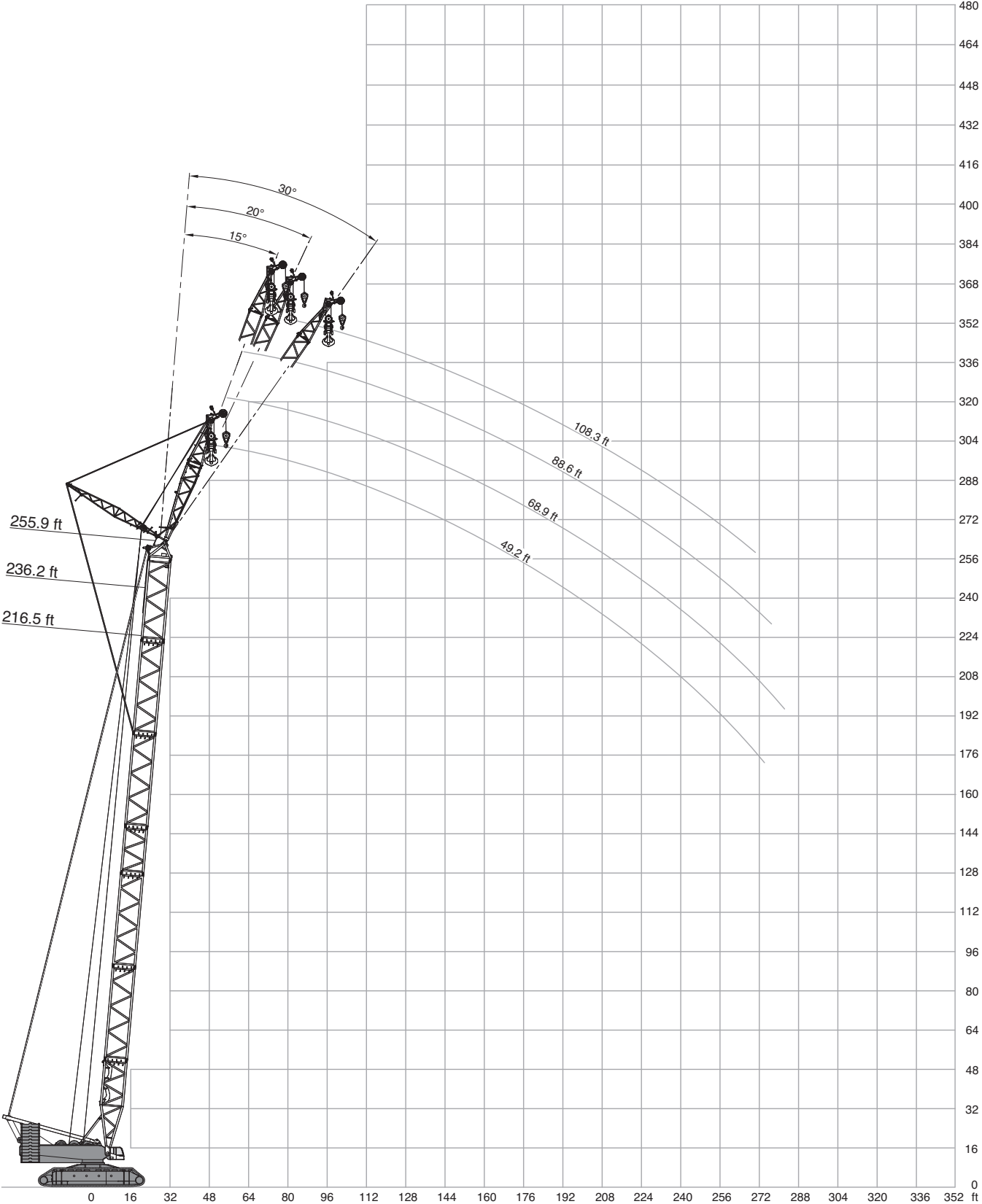

Operation

SH+LF

+ 49.2-108.3 ft 31.5 ft 32.2 ft/s 360° ASME B30.5																	
216.5 ft																	
49.2 ft				68.9 ft				88.6 ft				108.3 ft					
15°			20°			30°			15°			20°			30°		
ft	1,000 lb												ft				
45.9	551.2	-	-	-	-	-	-	-	-	-	-	-	-	45.9			
49.2	551.2	544.5	-	-	-	-	-	-	-	-	-	-	-	49.2			
52.5	551.2	544.5	-	504.9	-	-	-	-	-	-	-	-	-	52.5			
55.8	518.1	524.7	335.1	504.9	-	-	-	-	-	-	-	-	-	55.8			
59.1	487.2	493.8	335.1	482.8	399.0	-	392.4	-	-	-	-	-	-	59.1			
65.6	432.1	438.7	330.7	429.9	390.2	-	392.4	302.0	-	313.1	-	-	-	65.6			
68.9	409.0	415.6	327.4	407.9	381.4	246.9	382.5	302.0	-	313.1	-	-	-	68.9			
72.2	385.8	392.4	324.1	385.8	372.6	246.9	372.6	302.0	-	313.1	-	-	-	72.2			
75.5	367.1	372.6	320.8	367.1	362.7	242.5	359.4	295.4	-	305.3	235.9	-	-	75.5			
78.7	348.3	352.7	317.5	348.3	352.7	238.1	346.1	288.8	185.2	297.6	235.9	-	-	78.7			
85.3	315.3	319.7	310.9	315.3	321.9	231.5	315.3	277.8	185.2	284.4	231.5	-	-	85.3			
91.9	286.6	291.0	297.6	286.6	293.2	224.9	288.8	266.8	179.7	271.2	222.7	143.3	-	91.9			
98.4	262.4	264.6	273.4	262.4	266.8	218.3	264.6	255.7	174.2	257.9	213.8	143.3	-	98.4			
111.5	220.5	222.7	229.3	222.7	227.1	207.2	222.7	229.3	164.2	222.7	198.4	134.5	-	111.5			
124.7	183.0	185.2	189.6	187.4	190.7	196.2	191.8	196.2	156.5	191.8	184.1	126.8	-	124.7			
137.8	154.3	156.0	159.3	157.6	160.4	165.9	161.5	165.3	148.3	164.8	165.9	120.2	-	137.8			
150.9	129.5	130.6	133.9	132.8	135.6	140.5	136.7	140.0	139.4	139.4	143.3	113.5	-	150.9			
164.0	108.5	109.8	112.9	112.0	114.8	119.0	116.1	119.3	124.6	118.4	122.4	107.9	-	164.0			
177.2	90.9	92.5	95.0	94.6	96.7	100.5	98.2	101.2	106.2	100.5	103.9	103.3	-	177.2			
190.3	76.1	77.3	79.4	79.1	81.2	84.7	82.9	85.5	90.2	85.0	88.2	93.7	-	190.3			
203.4	63.6	64.6	66.2	66.6	68.1	71.0	69.8	71.9	76.1	71.7	74.3	79.8	-	203.4			
206.7	60.7	61.6	63.1	63.6	65.0	67.8	66.7	68.9	72.8	68.7	71.3	76.5	-	206.7			
216.5	52.6	53.4	-	55.1	56.7	59.1	58.5	60.5	63.9	60.3	62.8	67.2	-	216.5			
226.4	45.4	46.0	-	48.0	49.1	51.1	51.0	52.7	55.7	52.5	54.8	59.0	-	226.4			
229.7	43.2	43.7	-	45.7	46.7	-	48.7	50.3	53.1	50.2	52.2	56.4	-	229.7			
232.9	41.0	41.4	-	43.5	44.4	-	46.4	48.0	50.7	47.9	49.9	53.9	-	232.9			
242.8	34.8	-	-	37.3	38.1	-	40.0	41.4	43.9	41.4	43.3	46.8	-	242.8			
246.1	-	-	-	35.3	36.2	-	38.0	39.4	41.7	39.4	41.2	44.6	-	246.1			
252.6	-	-	-	31.5	32.2	-	34.1	35.4	-	35.4	37.1	40.3	-	252.6			
255.9	-	-	-	29.8	-	-	32.3	33.6	-	33.6	35.3	38.4	-	255.9			
262.5	-	-	-	26.2	-	-	28.9	30.0	-	30.0	31.5	34.4	-	262.5			
265.7	-	-	-	-	-	-	27.3	28.2	-	28.4	29.8	32.4	-	265.7			
269.0	-	-	-	-	-	-	25.7	26.5	-	26.8	28.1	-	-	269.0			
282.2	-	-	-	-	-	-	19.6	-	-	20.7	21.8	-	-	282.2			
288.7	-	-	-	-	-	-	-	-	-	17.9	18.7	-	-	288.7			
295.3	-	-	-	-	-	-	-	-	-	15.2	-	-	-	295.3			
298.6	-	-	-	-	-	-	-	-	-	13.9	-	-	-	298.6			

286,600 lb 374,800 lb 463,000 lb 551,200 lb

Operation

SH+LF

+ 49.2-108.3 ft 31.5 ft 32.2 ft/s 360° ASME B30.5													
236.2 ft													
49.2 ft			68.9 ft				88.6 ft			108.3 ft			
15°		20°	30°	15°	20°	30°	15°	20°	30°	15°	20°	30°	ft
1,000 lb													ft
45.9	551.2	-	-	-	-	-	-	-	-	-	-	-	45.9
52.5	531.3	537.9	-	513.7	-	-	-	-	-	-	-	-	52.5
59.1	467.4	474.0	335.1	463.0	392.4	-	385.8	-	-	-	-	-	59.1
65.6	414.5	421.1	332.9	412.3	392.4	-	385.8	-	-	308.6	-	-	65.6
68.9	392.4	399.0	329.6	391.3	384.7	244.7	377.0	297.6	-	308.6	-	-	68.9
72.2	370.4	377.0	326.3	370.4	377.0	244.7	368.2	297.6	-	308.6	-	-	72.2
75.5	351.6	358.3	323.0	351.6	358.3	242.5	350.5	294.3	-	305.3	233.7	-	75.5
78.7	332.9	339.5	319.7	332.9	339.5	240.3	332.9	291.0	-	302.0	233.7	-	78.7
82.0	317.5	323.0	316.4	317.5	324.1	237.0	317.5	285.5	183.0	294.3	233.7	-	82.0
85.3	302.0	306.4	313.1	302.0	308.6	233.7	302.0	280.0	183.0	286.6	233.7	-	85.3
91.9	273.4	277.8	286.6	275.6	280.0	227.1	275.6	271.2	180.8	275.6	224.9	142.2	91.9
98.4	249.1	253.5	260.1	251.3	255.7	220.5	253.5	260.1	175.3	251.3	217.2	142.2	98.4
111.5	209.4	212.7	219.4	211.6	216.1	210.5	213.8	219.4	166.4	213.8	201.7	135.6	111.5
124.7	177.5	179.7	185.2	179.7	184.1	190.7	181.9	187.4	158.7	183.0	188.5	129.0	124.7
137.8	148.3	150.5	154.9	152.1	156.0	161.5	156.0	159.8	151.0	157.1	162.0	121.3	137.8
150.9	122.9	124.6	129.0	126.8	130.1	135.6	131.2	135.0	138.9	133.9	138.3	115.2	150.9
164.0	101.7	103.2	107.0	105.3	108.2	113.4	109.7	113.5	120.0	112.7	117.0	110.0	164.0
177.2	83.8	85.3	88.6	87.5	90.2	94.7	91.9	95.1	101.1	94.5	98.4	102.2	177.2
190.3	69.1	70.7	73.1	72.6	74.7	78.3	76.3	78.9	84.5	78.5	82.2	89.0	190.3
203.4	56.2	57.3	59.5	59.3	61.4	64.8	63.2	65.8	70.3	65.4	68.6	74.3	203.4
216.5	45.4	46.4	48.2	48.4	50.0	52.8	51.8	53.9	58.0	53.6	56.6	61.8	216.5
223.1	40.3	41.2	42.8	43.2	44.8	47.2	46.5	48.5	52.2	48.3	51.1	56.0	223.1
229.7	35.8	36.7	-	38.6	40.0	42.3	41.9	43.8	47.3	43.5	46.2	50.8	229.7
242.8	27.4	28.2	-	30.0	31.1	33.1	33.0	34.8	37.8	34.7	36.9	41.1	242.8
249.3	23.6	24.3	-	26.0	27.1	-	28.9	30.6	33.3	30.6	32.6	36.6	249.3
255.9	20.1	-	-	22.5	23.5	-	25.4	26.9	29.3	26.9	28.8	32.3	255.9
259.2	18.3	-	-	20.7	21.7	-	23.6	25.0	27.3	25.0	27.0	30.2	259.2
269.0	-	-	-	15.9	16.5	-	18.5	19.8	-	19.8	21.7	24.7	269.0
278.9	-	-	-	11.2	-	-	13.8	15.0	-	15.1	16.8	19.4	278.9
282.2	-	-	-	-	-	-	12.3	13.4	-	13.6	15.2	-	282.2
285.4	-	-	-	-	-	-	-	11.9	-	12.1	13.7	-	285.4
288.7	-	-	-	-	-	-	-	-	-	-	12.1	-	288.7

286,600 lb 374,800 lb 463,000 lb 551,200 lb

Operation

SH+LF

+ 49.2-108.3 ft 31.5 ft 32.2 ft/s 360° ASME B30.5													
255.9 ft													
49.2 ft			68.9 ft				88.6 ft			108.3 ft			
15° 20° 30°			15° 20° 30°				15° 20° 30°			15° 20° 30°			
ft	1,000 lb												ft
49.2	546.7	-	-	-	-	-	-	-	-	-	-	-	49.2
52.5	509.3	518.1	-	513.7	-	-	-	-	-	-	-	-	52.5
59.1	449.7	456.4	332.9	463.0	-	-	-	-	-	-	-	-	59.1
62.3	423.3	429.9	332.9	436.5	388.0	-	390.2	-	-	-	-	-	62.3
65.6	399.0	405.7	332.9	412.3	388.0	-	390.2	-	-	-	-	-	65.6
68.9	378.1	383.6	329.6	391.3	375.9	-	372.6	295.4	-	308.6	-	-	68.9
72.2	357.1	361.6	326.3	370.4	363.8	242.5	354.9	295.4	-	308.6	-	-	72.2
78.7	319.7	326.3	319.7	332.9	328.5	242.5	321.9	295.4	-	308.6	235.9	-	78.7
82.0	304.2	309.7	312.0	317.5	313.1	239.2	306.4	289.9	181.9	299.8	235.9	-	82.0
85.3	288.8	293.2	304.2	302.0	297.6	235.9	291.0	284.4	181.9	291.0	235.9	-	85.3
91.9	262.4	266.8	275.6	275.6	269.0	229.3	264.6	273.4	181.9	264.6	227.1	-	91.9
95.1	250.2	254.6	263.5	263.5	257.9	226.0	253.5	261.2	179.7	253.5	223.2	142.2	95.1
98.4	238.1	242.5	251.3	251.3	246.9	222.7	242.5	249.1	177.5	242.5	219.4	142.2	98.4
111.5	199.5	203.9	210.5	211.6	207.2	212.7	203.9	210.5	168.7	205.0	205.0	136.7	111.5
124.7	168.7	170.9	177.5	179.7	174.2	183.0	173.1	178.6	159.8	174.2	180.8	130.1	124.7
137.8	141.6	144.4	149.4	152.1	148.8	156.0	148.3	152.7	152.7	149.4	154.9	123.5	137.8
150.9	117.3	119.5	123.5	126.8	124.6	131.2	125.7	129.5	137.8	127.9	132.8	116.8	150.9
164.0	95.9	98.1	101.6	105.3	102.8	108.8	104.7	108.2	116.1	107.8	112.3	111.3	164.0
177.2	78.2	80.1	83.2	87.5	84.4	89.7	86.1	89.9	96.5	89.2	93.5	100.8	177.2
190.3	62.8	64.7	67.7	72.6	69.1	73.5	70.9	74.0	79.4	73.4	77.0	84.5	190.3
203.4	50.3	51.7	54.2	59.3	55.6	59.3	57.4	60.1	65.5	59.7	63.3	69.9	203.4
216.5	39.2	40.5	42.7	48.4	44.2	47.5	46.0	48.5	52.9	48.2	51.3	57.0	216.5
229.7	29.7	30.6	32.3	38.6	34.0	36.9	35.9	38.1	42.1	37.9	40.7	46.0	229.7
236.2	25.1	26.0	27.8	34.0	29.5	32.0	31.3	33.3	37.0	33.1	35.7	40.8	236.2
242.8	21.2	22.0	-	30.0	25.4	27.7	27.1	29.1	32.4	28.9	31.3	36.2	242.8
255.9	13.7	14.4	-	22.5	17.5	19.4	19.3	21.1	24.0	20.9	23.3	27.3	255.9
259.2	11.9	12.6	-	20.7	15.7	-	17.5	19.1	22.0	19.1	21.3	25.2	259.2
265.7	-	-	-	17.4	12.1	-	14.0	15.5	18.3	15.5	17.7	21.3	265.7
269.0	-	-	-	15.9	-	-	12.3	13.8	16.5	13.8	16.0	19.5	269.0
272.3	-	-	-	14.3	-	-	-	12.1	14.8	12.1	14.3	17.7	272.3
275.6	-	-	-	12.8	-	-	-	-	13.0	-	12.6	15.9	275.6
278.9	-	-	-	11.2	-	-	-	-	-	-	-	14.1	278.9
282.2	-	-	-	-	-	-	-	-	-	-	-	12.3	282.2

286,600 lb
 374,800 lb
 463,000 lb
 551,200 lb

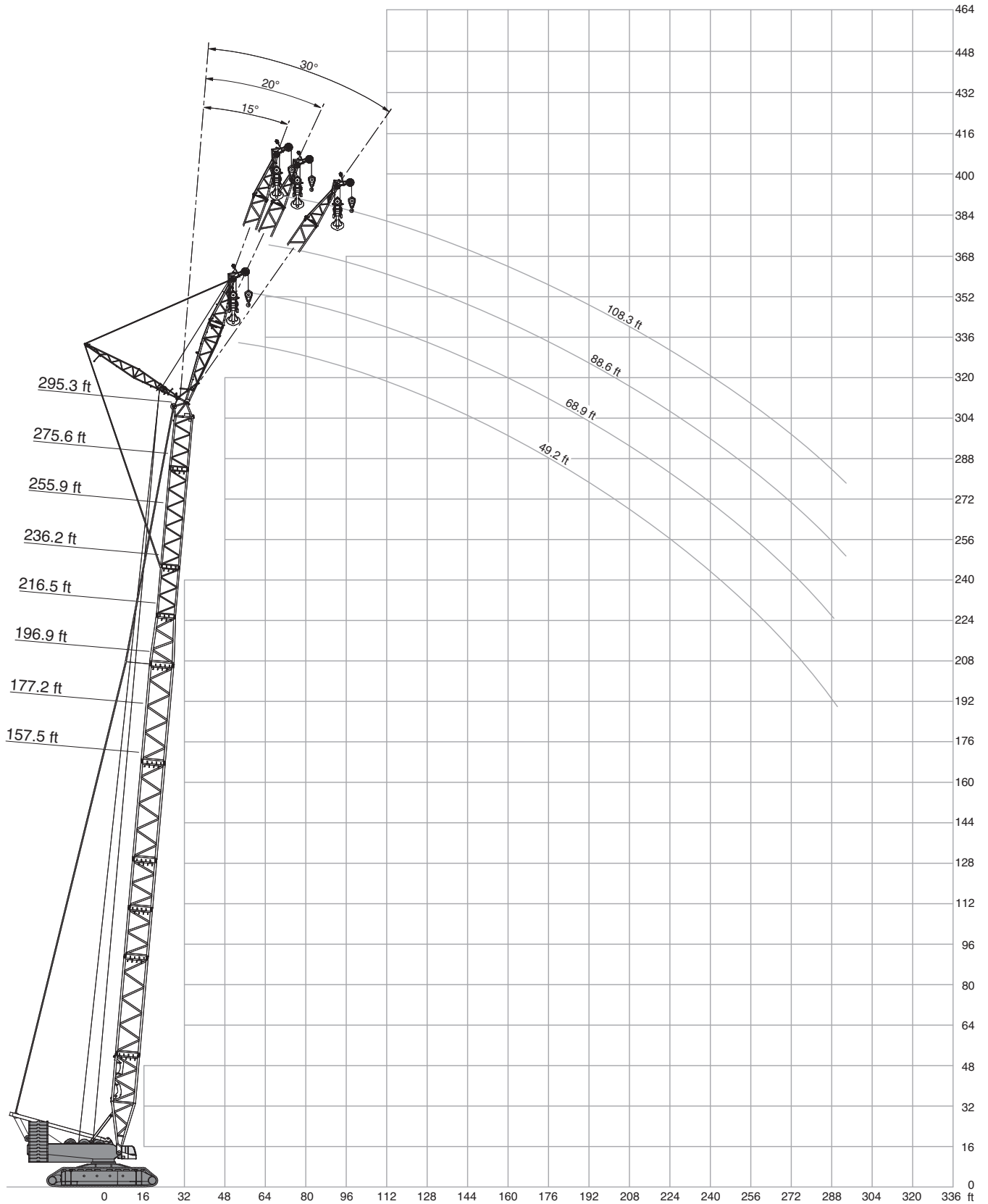

Operation

SH/LH+LF

+ 49.2-108.3 ft 31.5 ft 32.2 ft/s 360° ASME B30.5													
157.5 ft													
49.2 ft			68.9 ft				88.6 ft			108.3 ft			
15°	20°	30°	15°	20°	30°	15°	20°	30°	15°	20°	30°		
ft													ft
													1,000 lb
39.4	551.2	-	-	-	-	-	-	-	-	-	-	-	39.4
42.7	551.2	551.2	-	-	-	-	-	-	-	-	-	-	42.7
45.9	551.2	551.2	-	524.7	-	-	-	-	-	-	-	-	45.9
49.2	551.2	551.2	343.9	524.7	-	-	-	-	-	-	-	-	49.2
52.5	551.2	540.1	340.6	507.1	407.9	-	394.6	-	-	-	-	-	52.5
59.1	537.9	514.8	332.9	474.0	395.7	-	388.0	308.6	-	315.3	-	-	59.1
62.3	524.7	500.4	328.5	458.6	383.6	251.3	381.4	308.6	-	315.3	-	-	62.3
65.6	497.1	487.2	323.0	444.2	373.7	248.0	370.4	303.1	-	310.9	-	-	65.6
68.9	469.6	474.0	317.5	429.9	363.8	244.7	359.4	297.6	-	306.4	246.9	-	68.9
72.2	447.5	451.9	313.8	418.1	354.2	240.3	349.1	289.5	187.4	297.6	241.8	-	72.2
78.7	403.4	407.9	306.4	394.6	335.1	231.5	328.5	273.4	187.4	280.0	231.5	-	78.7
85.3	363.8	367.1	297.6	361.6	319.7	223.2	310.9	260.1	180.8	265.7	220.5	147.7	85.3
91.9	324.1	326.3	288.8	328.5	304.2	215.0	293.2	246.9	174.2	251.3	209.4	144.4	91.9
98.4	295.4	297.6	280.0	298.7	288.8	208.3	278.9	235.9	167.6	238.1	199.5	138.9	98.4
111.5	245.8	248.0	250.2	248.0	251.3	195.7	246.9	215.5	155.4	214.4	181.3	128.4	111.5
124.7	208.3	210.0	212.2	210.5	212.7	184.6	212.7	198.4	145.5	195.1	166.4	119.6	124.7
137.8	179.7	180.4	182.6	181.5	183.4	173.4	183.7	180.8	137.1	177.5	154.3	112.3	137.8
150.9	155.4	155.4	157.6	156.5	157.6	160.9	158.7	160.9	129.0	159.8	143.3	105.4	150.9
164.0	137.1	137.1	138.2	138.2	139.3	141.8	139.6	141.8	123.1	140.7	133.7	99.9	164.0
167.3	132.5	132.5	133.4	133.6	134.7	137.1	134.8	137.1	121.6	136.0	131.4	98.6	167.3
177.2	120.9	120.7	-	122.0	122.9	124.6	123.2	124.9	117.6	124.0	122.7	95.1	177.2
183.7	113.9	113.5	-	115.0	115.8	116.8	116.3	117.6	115.0	116.9	116.5	93.0	183.7
190.3	106.9	-	-	108.0	108.7	-	109.3	110.2	112.4	109.8	110.2	90.8	190.3
203.4	-	-	-	96.7	97.0	-	98.0	98.9	100.1	98.2	99.2	87.5	203.4
210.0	-	-	-	91.1	-	-	92.4	93.3	-	92.4	93.7	85.8	210.0
216.5	-	-	-	-	-	-	87.5	88.2	-	87.5	88.7	84.7	216.5
223.1	-	-	-	-	-	-	82.7	83.1	-	82.7	83.7	83.6	223.1
229.7	-	-	-	-	-	-	77.8	-	-	77.8	78.7	-	229.7
239.5	-	-	-	-	-	-	-	-	-	71.8	72.3	-	239.5
242.8	-	-	-	-	-	-	-	-	-	69.7	-	-	242.8
249.3	-	-	-	-	-	-	-	-	-	65.7	-	-	249.3

286,600 lb 374,800 lb 463,000 lb 551,200 lb

Operation

SH/LH+LF

+ 49.2-108.3 ft 31.5 ft 32.2 ft/s 360° ASME B30.5														
177.2 ft														
49.2 ft			68.9 ft				88.6 ft			108.3 ft				
15°		20°	30°	15°	20°	30°	15°	20°	30°	15°	20°	30°	ft	
1,000 lb														
ft														ft
42.7	551.2	-	-	-	-	-	-	-	-	-	-	-	42.7	
45.9	551.2	551.2	-	-	-	-	-	-	-	-	-	-	45.9	
49.2	551.2	551.2	-	515.9	-	-	-	-	-	-	-	-	49.2	
52.5	551.2	544.5	339.5	507.1	401.2	-	-	-	-	-	-	-	52.5	
55.8	551.2	537.9	339.5	498.2	401.2	-	401.2	-	-	-	-	-	55.8	
59.1	528.0	524.7	335.1	482.8	395.7	-	394.6	-	-	-	-	-	59.1	
62.3	504.9	511.5	330.7	467.4	390.2	249.1	388.0	313.1	-	319.7	-	-	62.3	
65.6	478.4	483.9	326.3	454.2	380.3	249.1	377.0	308.6	-	315.3	-	-	65.6	
68.9	451.9	456.4	321.9	440.9	370.4	249.1	366.0	304.2	-	310.9	244.7	-	68.9	
72.2	430.6	435.0	318.2	421.8	362.3	244.0	355.7	296.2	-	302.0	241.8	-	72.2	
75.5	409.3	413.7	314.5	402.7	354.2	238.8	345.4	288.1	189.6	293.2	238.8	-	75.5	
78.7	388.0	392.4	310.9	383.6	346.1	233.7	335.1	280.0	189.6	284.4	235.9	-	78.7	
85.3	353.8	357.1	303.1	352.7	330.7	226.5	319.7	266.8	183.0	271.2	224.9	146.6	85.3	
91.9	319.7	321.9	295.4	321.9	315.3	219.4	304.2	253.5	176.4	257.9	213.8	145.5	91.9	
98.4	291.0	293.2	282.2	293.2	292.1	212.7	286.6	242.5	170.3	245.8	204.5	140.0	98.4	
111.5	241.4	242.5	246.9	243.6	246.9	200.6	246.9	222.7	158.7	223.2	186.8	130.1	111.5	
124.7	203.9	204.5	207.8	206.1	208.3	189.6	208.3	203.9	148.8	202.8	172.0	121.8	124.7	
137.8	174.9	176.0	177.8	176.7	178.9	174.9	178.9	181.1	140.7	180.0	159.5	114.6	137.8	
150.9	149.9	151.0	152.1	151.0	153.2	156.5	153.2	155.4	133.4	154.3	147.7	107.8	150.9	
164.0	131.5	131.9	133.7	132.6	134.1	136.7	134.8	136.3	126.8	135.2	134.5	102.4	164.0	
177.2	115.2	115.4	116.5	116.4	117.5	119.5	118.5	119.6	118.3	118.7	120.7	97.4	177.2	
180.4	111.6	111.9	112.4	112.9	114.0	115.9	114.9	116.1	115.7	115.2	117.2	96.3	180.4	
190.3	100.8	101.4	-	102.3	103.4	104.9	104.1	105.4	108.0	104.7	106.5	93.0	190.3	
200.1	91.8	91.9	-	93.3	94.2	95.5	95.0	96.3	98.8	95.6	97.3	90.4	200.1	
203.4	88.8	-	-	90.2	91.2	-	92.0	93.3	95.7	92.5	94.3	89.5	203.4	
206.7	85.8	-	-	87.2	88.1	-	89.0	90.3	92.6	89.5	91.2	88.6	206.7	
216.5	-	-	-	79.3	79.8	-	81.1	82.2	83.8	81.4	83.0	83.6	216.5	
219.8	-	-	-	76.8	77.2	-	78.6	79.7	-	78.9	80.5	81.5	219.8	
226.4	-	-	-	71.9	-	-	73.7	74.6	-	73.9	75.3	77.3	226.4	
229.7	-	-	-	-	-	-	71.2	72.1	-	71.4	72.8	75.2	229.7	
236.2	-	-	-	-	-	-	67.0	67.8	-	67.1	68.4	70.5	236.2	
239.5	-	-	-	-	-	-	64.9	65.7	-	65.0	66.3	-	239.5	
242.8	-	-	-	-	-	-	62.8	-	-	62.8	64.1	-	242.8	
246.1	-	-	-	-	-	-	61.1	-	-	61.0	61.9	-	246.1	
255.9	-	-	-	-	-	-	-	-	-	55.6	56.4	-	255.9	
265.7	-	-	-	-	-	-	-	-	-	50.5	-	-	265.7	

286,600 lb 374,800 lb 463,000 lb 551,200 lb

Operation

SH/LH+LF

49.2-108.3 ft 31.5 ft 32.2 ft/s 360° ASME B30.5																	
196.9 ft																	
49.2 ft				68.9 ft				88.6 ft				108.3 ft					
15°			20°			30°			15°			20°			30°		
ft	1,000 lb												ft				
42.7	551.2	-	-	-	-	-	-	-	-	-	-	-	-	42.7			
45.9	551.2	551.2	-	-	-	-	-	-	-	-	-	-	-	45.9			
49.2	551.2	551.2	-	507.1	-	-	-	-	-	-	-	-	-	49.2			
52.5	550.1	550.1	-	507.1	-	-	-	-	-	-	-	-	-	52.5			
55.8	549.0	549.0	337.3	507.1	405.7	-	394.6	-	-	-	-	-	-	55.8			
59.1	518.1	520.3	335.1	491.6	401.2	-	394.6	-	-	-	-	-	-	59.1			
62.3	487.2	491.6	332.9	476.2	396.8	-	394.6	306.4	-	315.3	-	-	-	62.3			
65.6	460.8	465.2	329.6	453.1	386.9	249.1	383.6	306.4	-	315.3	-	-	-	65.6			
72.2	413.7	418.1	322.6	410.1	368.9	243.6	363.0	299.8	-	307.2	240.3	-	-	72.2			
75.5	393.2	397.6	318.9	390.2	360.8	240.9	353.5	293.2	187.4	299.1	240.3	-	-	75.5			
78.7	372.6	377.0	315.3	370.4	352.7	238.1	343.9	286.6	187.4	291.0	240.3	-	-	78.7			
85.3	341.7	345.0	307.5	339.5	332.9	230.4	325.2	273.4	183.0	276.7	229.3	-	-	85.3			
88.6	326.3	329.0	303.7	324.1	323.0	226.5	315.8	266.8	180.8	269.5	223.8	144.4	-	88.6			
91.9	310.9	313.1	299.8	308.6	313.1	222.7	306.4	260.1	178.6	262.4	218.3	144.4	-	91.9			
98.4	284.4	286.6	282.2	284.4	288.8	216.1	284.4	249.1	172.5	251.3	208.9	140.5	-	98.4			
111.5	236.4	238.7	242.5	239.2	242.5	203.9	241.4	229.3	161.5	229.8	191.8	132.3	-	111.5			
124.7	198.4	200.1	203.4	201.2	203.4	193.5	203.9	205.6	152.1	203.9	176.9	124.0	-	124.7			
137.8	169.4	170.5	173.4	171.6	173.4	176.4	174.5	177.5	144.0	175.6	164.2	116.8	-	137.8			
150.9	144.4	145.5	147.7	146.6	147.7	152.1	148.8	151.0	136.7	149.9	153.2	110.0	-	150.9			
164.0	125.3	126.4	128.6	127.5	129.3	132.3	129.7	131.9	129.3	130.8	133.4	104.6	-	164.0			
177.2	108.5	109.5	111.5	110.6	112.5	114.8	112.8	114.9	118.2	113.8	116.1	99.6	-	177.2			
190.3	93.9	94.8	96.3	95.9	97.2	99.6	98.1	100.1	103.4	99.0	101.4	95.2	-	190.3			
193.6	90.9	91.8	92.8	92.9	94.1	96.5	95.0	96.9	100.2	95.9	98.2	93.7	-	193.6			
203.4	82.0	82.7	-	83.7	84.7	86.9	85.8	87.5	90.5	86.5	88.6	89.1	-	203.4			
213.3	73.5	74.1	-	75.1	75.9	77.6	77.0	78.6	81.3	77.7	79.7	83.3	-	213.3			
216.5	70.9	71.4	-	72.5	73.4	-	74.5	76.1	78.6	75.1	77.1	80.5	-	216.5			
226.4	63.9	-	-	65.1	65.9	-	66.8	68.5	70.6	67.5	69.4	72.4	-	226.4			
229.7	-	-	-	62.8	63.5	-	64.6	65.9	67.9	65.0	66.8	69.7	-	229.7			
232.9	-	-	-	60.8	61.4	-	62.6	63.8	65.5	63.0	64.7	67.4	-	232.9			
236.2	-	-	-	58.8	59.3	-	60.6	61.7	-	60.9	62.5	65.0	-	236.2			
242.8	-	-	-	54.7	-	-	56.5	57.5	-	56.8	58.3	60.6	-	242.8			
249.3	-	-	-	-	-	-	52.5	53.4	-	52.7	54.0	56.2	-	249.3			
252.6	-	-	-	-	-	-	50.7	51.4	-	50.9	52.2	-	-	252.6			
255.9	-	-	-	-	-	-	48.9	-	-	49.0	50.4	-	-	255.9			
262.5	-	-	-	-	-	-	45.4	-	-	45.6	46.7	-	-	262.5			
269.0	-	-	-	-	-	-	-	-	-	42.3	43.2	-	-	269.0			
272.3	-	-	-	-	-	-	-	-	-	40.8	41.7	-	-	272.3			
282.2	-	-	-	-	-	-	-	-	-	36.4	-	-	-	282.2			

286,600 lb
374,800 lb
463,000 lb
551,200 lb

Operation

SH/LH+LF

+ 49.2-108.3 ft 31.5 ft 32.2 ft/s 360° ASME B30.5														
216.5 ft														
49.2 ft			68.9 ft				88.6 ft			108.3 ft				
15°	20°	30°	15°	20°	30°	15°	20°	30°	15°	20°	30°	15°	20°	30°
1,000 lb														
ft													ft	
45.9	551.2	-	-	-	-	-	-	-	-	-	-	-	-	45.9
49.2	551.2	551.2	-	-	-	-	-	-	-	-	-	-	-	49.2
52.5	541.2	544.5	-	522.5	-	-	-	-	-	-	-	-	-	52.5
55.8	531.3	537.9	348.3	522.5	416.7	-	-	-	-	-	-	-	-	55.8
59.1	501.6	507.1	346.1	493.8	414.5	-	405.7	-	-	-	-	-	-	59.1
65.6	446.4	450.8	340.6	440.9	401.2	260.1	399.0	315.3	-	319.7	-	-	-	65.6
72.2	401.2	405.7	333.6	397.6	381.4	252.4	380.7	303.1	-	312.0	255.7	-	-	72.2
78.7	361.6	366.0	326.3	359.4	363.8	244.7	357.1	291.0	194.0	304.2	242.5	-	-	78.7
85.3	331.8	335.1	318.6	329.6	334.0	237.0	327.4	278.9	187.4	288.8	232.6	-	-	85.3
88.6	316.9	319.7	314.7	314.7	319.1	233.1	312.5	272.8	184.1	281.1	227.6	151.0	-	88.6
91.9	302.0	304.2	310.9	299.8	304.2	229.3	297.6	266.8	180.8	273.4	222.7	147.7	-	91.9
98.4	278.9	281.1	286.6	276.7	281.1	222.7	275.6	255.7	174.7	260.1	213.3	142.7	-	98.4
111.5	234.2	236.4	240.3	234.8	238.1	210.0	236.4	233.7	163.7	232.6	196.2	133.4	-	111.5
124.7	196.2	197.9	201.2	199.0	201.2	196.8	202.3	205.6	154.3	202.3	181.3	125.1	-	124.7
137.8	166.8	168.3	171.2	169.0	171.2	176.4	172.3	175.3	146.2	173.4	166.4	117.9	-	137.8
150.9	141.1	143.3	145.5	143.3	145.5	149.9	146.6	148.8	138.9	147.7	151.0	111.3	-	150.9
164.0	122.7	124.2	126.4	124.9	126.4	130.1	127.5	129.7	128.6	128.6	131.2	106.3	-	164.0
177.2	105.9	107.0	109.1	108.0	109.3	112.4	110.2	112.4	115.9	111.3	113.6	101.6	-	177.2
190.3	90.6	91.7	93.5	92.4	94.1	96.8	94.8	96.8	100.8	95.7	98.3	97.2	-	190.3
203.4	78.6	79.5	80.8	80.2	81.6	84.0	82.3	84.1	87.5	83.2	85.5	87.8	-	203.4
206.7	75.5	76.5	77.6	77.1	78.5	80.8	79.2	81.0	84.2	80.1	82.3	85.5	-	206.7
216.5	67.5	68.3	-	69.0	69.9	72.0	70.8	72.5	75.5	71.5	73.7	77.7	-	216.5
226.4	60.5	61.1	-	61.7	62.6	64.2	63.4	64.8	67.5	63.9	65.9	69.5	-	226.4
229.7	58.2	58.6	-	59.3	60.2	-	61.1	62.4	65.0	61.5	63.5	66.8	-	229.7
232.9	56.2	56.4	-	57.2	58.1	-	59.0	60.3	62.8	59.4	61.3	64.6	-	232.9
242.8	50.0	-	-	51.0	51.9	-	52.8	54.0	56.0	53.1	54.8	57.8	-	242.8
246.1	-	-	-	48.9	49.8	-	50.8	51.9	53.8	51.0	52.7	55.6	-	246.1
252.6	-	-	-	45.5	46.1	-	47.0	47.8	-	47.2	48.5	51.4	-	252.6
255.9	-	-	-	43.8	-	-	45.3	46.1	-	45.5	46.7	49.4	-	255.9
262.5	-	-	-	40.3	-	-	42.0	42.7	-	42.0	43.2	45.5	-	262.5
265.7	-	-	-	-	-	-	40.3	41.0	-	40.3	41.4	43.7	-	265.7
269.0	-	-	-	-	-	-	38.6	39.2	-	38.6	39.7	-	-	269.0
278.9	-	-	-	-	-	-	34.2	-	-	34.2	35.2	-	-	278.9
282.2	-	-	-	-	-	-	-	-	-	32.7	33.7	-	-	282.2
288.7	-	-	-	-	-	-	-	-	-	29.8	30.6	-	-	288.7
295.3	-	-	-	-	-	-	-	-	-	27.2	-	-	-	295.3
298.6	-	-	-	-	-	-	-	-	-	26.0	-	-	-	298.6

286,600 lb 374,800 lb 463,000 lb 551,200 lb

Operation

SH/LH+LF

49.2-108.3 ft 31.5 ft 32.2 ft/s 360° ASME B30.5													
236.2 ft													
49.2 ft			68.9 ft				88.6 ft			108.3 ft			
15°			20°		30°		15°		20°		30°		
ft	1,000 lb											ft	
45.9	551.2	-	-	-	-	-	-	-	-	-	-	45.9	
49.2	551.2	549.0	-	-	-	-	-	-	-	-	-	49.2	
52.5	531.3	533.5	-	511.5	-	-	-	-	-	-	-	52.5	
59.1	482.8	489.4	339.5	477.3	399.0	-	394.6	-	-	-	-	59.1	
65.6	431.0	436.5	335.1	426.6	395.7	-	390.2	308.6	-	306.4	-	65.6	
68.9	407.9	412.3	330.7	403.4	392.4	249.1	385.8	305.3	-	305.3	-	68.9	
72.2	388.7	393.2	327.8	385.1	379.2	247.7	372.6	302.0	-	304.2	-	72.2	
75.5	369.6	374.1	324.8	366.7	366.0	246.2	359.4	298.7	-	303.1	242.5	75.5	
78.7	350.5	354.9	321.9	348.3	352.7	244.7	346.1	295.4	186.3	302.0	242.5	78.7	
85.3	320.8	325.2	312.0	319.7	324.1	238.1	317.5	283.3	184.1	289.9	233.7	85.3	
91.9	291.0	295.4	302.0	291.0	295.4	231.5	288.8	271.2	181.9	277.8	224.9	146.6	91.9
98.4	269.0	272.3	278.9	267.9	272.3	225.4	266.8	260.1	176.4	261.2	216.1	142.7	98.4
111.5	228.2	230.4	235.9	227.6	232.0	213.3	228.2	232.6	165.9	227.6	199.5	134.5	111.5
124.7	192.9	194.6	199.0	194.6	198.4	196.8	196.8	200.6	157.1	196.8	185.2	126.8	124.7
137.8	163.5	165.0	168.7	165.7	168.7	173.1	169.0	172.0	149.5	170.1	168.3	120.2	137.8
150.9	137.8	140.0	142.2	140.0	142.2	146.6	143.3	145.5	142.2	144.4	147.7	113.5	150.9
164.0	118.8	120.2	123.1	120.9	123.1	126.8	123.5	126.4	128.2	125.3	127.9	108.4	164.0
177.2	101.7	102.7	105.5	103.6	105.7	108.9	105.9	108.9	113.2	107.7	110.2	103.5	177.2
190.3	86.4	87.5	89.5	88.2	89.9	93.0	90.6	93.0	97.2	91.7	94.6	99.0	190.3
203.4	73.9	74.7	76.8	75.7	77.5	80.1	78.1	80.2	84.0	79.1	81.6	86.2	203.4
216.5	63.3	64.2	65.5	64.7	66.1	68.2	66.8	68.4	71.7	67.6	69.4	74.1	216.5
223.1	58.4	59.2	60.2	59.8	61.1	63.1	61.7	63.3	66.2	62.5	64.4	68.3	223.1
229.7	53.6	54.2	-	54.9	56.0	58.0	56.7	58.2	61.1	57.3	59.3	63.3	229.7
239.5	47.5	48.1	-	48.5	49.5	51.1	50.0	51.8	54.3	50.7	52.7	56.4	239.5
242.8	45.5	46.1	-	46.5	47.5	-	48.1	49.6	52.1	48.6	50.5	54.2	242.8
249.3	41.7	42.1	-	42.5	43.4	-	44.3	45.6	47.8	44.5	46.3	49.6	249.3
255.9	38.3	-	-	39.2	40.0	-	40.9	42.0	43.9	41.0	42.7	45.7	255.9
259.2	36.6	-	-	37.5	38.3	-	39.1	40.2	41.9	39.2	40.9	43.8	259.2
265.7	-	-	-	34.1	34.8	-	35.7	36.6	-	35.7	37.3	39.9	265.7
269.0	-	-	-	32.4	-	-	34.0	34.8	-	34.0	35.5	37.9	269.0
278.9	-	-	-	28.2	-	-	29.3	30.4	-	29.3	30.7	32.8	278.9
282.2	-	-	-	-	-	-	27.9	28.9	-	27.9	29.1	-	282.2
285.4	-	-	-	-	-	-	26.5	27.3	-	26.5	27.7	-	285.4
295.3	-	-	-	-	-	-	22.6	-	-	22.6	23.7	-	295.3
298.6	-	-	-	-	-	-	21.4	-	-	21.4	22.4	-	298.6
305.1	-	-	-	-	-	-	-	-	-	18.9	19.8	-	305.1
308.4	-	-	-	-	-	-	-	-	-	17.6	-	-	308.4
315.0	-	-	-	-	-	-	-	-	-	15.4	-	-	315.0

286,600 lb
 374,800 lb
 463,000 lb
 551,200 lb

Operation

SH/LH+LF

+ 49.2-108.3 ft 31.5 ft 32.2 ft/s 360° ASME B30.5														
255.9 ft														
49.2 ft			68.9 ft				88.6 ft			108.3 ft				
15°	20°	30°	15°	20°	30°	15°	20°	30°	15°	20°	30°	15°	20°	30°
1,000 lb														
ft														ft
49.2	551.2	-	-	-	-	-	-	-	-	-	-	-	-	49.2
52.5	523.6	533.5	-	-	-	-	-	-	-	-	-	-	-	52.5
55.8	496.0	502.7	-	487.2	-	-	-	-	-	-	-	-	-	55.8
59.1	468.5	474.0	341.7	461.9	412.3	-	-	-	-	-	-	-	-	59.1
62.3	440.9	445.3	341.7	436.5	412.3	-	383.6	-	-	-	-	-	-	62.3
65.6	417.8	422.2	340.6	414.5	405.7	-	383.6	-	-	-	-	-	-	65.6
68.9	394.6	399.0	339.5	392.4	399.0	-	383.6	315.3	-	293.2	-	-	-	68.9
72.2	376.3	380.7	336.6	374.1	380.7	257.9	367.4	310.1	-	293.2	-	-	-	72.2
75.5	357.9	362.3	333.6	355.7	362.3	254.6	351.3	305.0	-	293.2	251.3	-	-	75.5
78.7	339.5	343.9	330.7	337.3	343.9	251.3	335.1	299.8	-	293.2	249.1	-	-	78.7
82.0	325.2	329.6	321.3	323.5	329.6	247.5	321.3	293.8	192.9	289.4	244.2	-	-	82.0
85.3	310.9	315.3	312.0	309.7	315.3	243.6	307.5	287.7	190.0	285.5	239.2	-	-	85.3
91.9	282.2	286.6	293.2	282.2	286.6	235.9	280.0	275.6	184.1	277.8	229.3	148.8	-	91.9
98.4	260.1	264.6	270.1	260.1	264.6	229.3	259.0	259.0	178.6	256.8	220.5	144.4	-	98.4
111.5	221.0	224.9	229.3	221.0	224.9	217.2	221.6	226.0	168.1	219.9	203.9	135.6	-	111.5
124.7	188.5	191.3	195.1	190.1	192.9	197.9	191.3	195.1	159.3	190.1	188.5	127.9	-	124.7
137.8	160.6	162.4	165.7	163.5	165.7	170.9	165.0	168.3	151.8	165.0	169.0	121.3	-	137.8
150.9	135.6	136.7	140.0	137.8	140.0	144.4	140.0	143.3	144.4	142.2	145.5	114.6	-	150.9
164.0	115.9	117.3	120.2	118.1	120.2	124.6	120.2	123.5	127.5	122.4	125.7	109.8	-	164.0
177.2	98.3	99.8	102.3	100.4	102.4	106.5	102.5	105.6	110.8	104.4	107.6	104.0	-	177.2
190.3	82.9	84.2	86.4	84.7	86.6	90.2	87.1	89.7	94.4	88.2	91.3	97.2	-	190.3
203.4	70.4	71.6	73.4	72.0	73.6	76.9	74.1	76.7	81.0	75.3	78.3	83.6	-	203.4
216.5	59.5	60.7	62.3	61.0	62.6	65.3	63.3	65.2	68.7	64.0	66.6	70.8	-	216.5
229.7	49.8	50.7	52.0	51.1	52.5	54.7	53.1	54.9	58.0	53.6	56.0	60.2	-	229.7
236.2	45.9	46.7	47.6	47.0	48.3	50.3	48.9	50.4	53.3	49.3	51.4	55.4	-	236.2
242.8	41.9	42.6	-	42.9	44.1	46.0	44.8	46.1	48.8	45.0	47.1	50.7	-	242.8
255.9	34.6	35.1	-	35.4	36.4	37.7	37.0	38.4	40.8	37.3	39.2	42.5	-	255.9
265.7	29.5	30.0	-	30.2	31.1	-	31.7	33.1	35.2	32.0	33.8	36.7	-	265.7
269.0	28.0	-	-	28.7	29.3	-	30.0	31.3	33.3	30.2	32.0	34.8	-	269.0
272.3	26.6	-	-	27.2	27.8	-	28.5	29.5	31.7	28.7	30.3	33.1	-	272.3
275.6	25.1	-	-	25.8	26.3	-	27.1	28.1	-	27.3	28.7	31.5	-	275.6
282.2	-	-	-	22.9	23.4	-	24.3	25.2	-	24.3	25.7	28.1	-	282.2
292.0	-	-	-	18.8	-	-	20.1	20.9	-	20.1	21.4	23.6	-	292.0
295.3	-	-	-	17.6	-	-	18.9	19.6	-	18.8	20.1	-	-	295.3
301.8	-	-	-	-	-	-	16.4	17.0	-	16.2	17.4	-	-	301.8
308.4	-	-	-	-	-	-	13.9	-	-	13.7	14.8	-	-	308.4
315.0	-	-	-	-	-	-	11.7	-	-	11.5	12.4	-	-	315.0
318.2	-	-	-	-	-	-	-	-	-	-	11.2	-	-	318.2

286,600 lb 374,800 lb 463,000 lb 551,200 lb

Operation

SH/LH+LF

+ 49.2-108.3 ft 31.5 ft 32.2 ft/s 360° ASME B30.5													
275.6 ft													
49.2 ft 68.9 ft 88.6 ft 108.3 ft													
15° 20° 30° 15° 20° 30° 15° 20° 30° 15° 20° 30°													
ft	1,000 lb												ft
49.2	529.1	-	-	-	-	-	-	-	-	-	-	-	49.2
52.5	503.8	471.8	-	-	-	-	-	-	-	-	-	-	52.5
55.8	478.4	471.8	-	410.1	-	-	-	-	-	-	-	-	55.8
59.1	453.1	451.9	-	410.1	-	-	-	-	-	-	-	-	59.1
62.3	427.7	432.1	328.5	410.1	352.7	-	326.3	-	-	-	-	-	62.3
65.6	405.7	410.1	328.5	394.6	352.7	-	326.3	-	-	-	-	-	65.6
68.9	383.6	388.0	328.5	379.2	352.7	-	326.3	277.8	-	269.0	-	-	68.9
72.2	365.2	369.6	325.5	361.6	346.1	246.9	325.5	277.8	-	269.0	-	-	72.2
78.7	328.5	332.9	319.7	326.3	332.9	246.9	324.1	277.8	-	269.0	224.9	-	78.7
82.0	314.7	319.1	310.9	313.1	319.1	243.6	311.4	277.2	185.2	268.4	224.9	-	82.0
85.3	300.9	305.3	302.0	299.8	305.3	240.3	298.7	276.7	185.2	267.9	224.9	-	85.3
91.9	273.4	277.8	284.4	273.4	277.8	233.7	273.4	275.6	185.2	266.8	224.9	-	91.9
95.1	262.9	266.8	273.4	262.9	267.3	230.9	262.9	265.7	182.4	257.4	222.4	143.3	95.1
98.4	252.4	255.7	262.4	252.4	256.8	228.2	252.4	255.7	179.7	248.0	219.9	142.6	98.4
111.5	214.4	217.2	222.7	214.4	218.8	215.5	215.0	219.4	169.8	213.3	207.2	136.7	111.5
124.7	183.5	186.3	190.7	183.5	187.4	194.0	184.6	189.0	160.9	184.1	187.4	129.0	124.7
137.8	157.3	159.5	163.5	158.0	161.3	167.2	159.8	163.9	153.2	159.8	164.2	122.7	137.8
150.9	132.3	134.5	137.8	134.5	137.8	142.2	137.8	141.1	146.6	137.8	142.2	116.8	150.9
164.0	112.6	114.5	117.7	114.8	117.5	121.6	117.8	120.5	126.8	118.7	122.4	111.6	164.0
177.2	95.0	96.6	99.6	97.1	99.4	103.2	99.8	102.3	108.4	101.0	104.4	104.1	177.2
190.3	79.6	80.9	83.6	81.4	83.6	87.1	83.8	86.4	91.5	84.9	88.2	94.6	190.3
203.4	67.4	68.5	70.5	68.9	70.5	73.6	71.0	73.2	78.1	71.7	74.7	80.8	203.4
216.5	56.0	57.1	59.1	57.5	59.1	62.2	59.5	61.9	65.9	60.4	63.3	68.0	216.5
229.7	46.5	47.4	48.9	47.6	49.2	51.6	49.6	51.6	54.9	50.3	52.7	57.1	229.7
242.8	38.3	39.2	40.6	39.4	40.6	42.9	41.1	42.9	45.9	41.6	43.9	47.6	242.8
249.3	34.2	35.1	36.4	35.3	36.4	38.6	36.8	38.6	41.4	37.3	39.5	43.2	249.3
255.9	30.6	31.3	-	31.6	32.7	34.7	33.3	34.9	37.7	33.6	35.8	39.4	255.9
269.0	24.3	24.9	-	24.9	25.8	27.6	26.5	27.8	30.2	26.7	28.4	31.7	269.0
282.2	18.7	19.0	-	19.2	19.9	-	20.4	21.8	23.7	20.6	22.3	25.1	282.2
288.7	15.9	-	-	16.3	17.0	-	17.4	18.7	20.5	17.6	19.2	21.8	288.7
292.0	14.6	-	-	15.0	15.7	-	16.2	17.4	-	16.3	17.9	20.4	292.0
295.3	-	-	-	13.8	14.5	-	14.9	16.1	-	15.0	16.5	18.9	295.3
298.6	-	-	-	12.5	13.2	-	13.7	14.8	-	13.7	15.2	17.5	298.6
301.8	-	-	-	11.2	-	-	12.5	13.4	-	12.3	13.9	16.0	301.8
305.1	-	-	-	-	-	-	11.2	12.1	-	11.0	12.6	14.6	305.1
308.4	-	-	-	-	-	-	-	-	-	-	11.2	-	308.4

286,600 lb **374,800 lb** 463,000 lb 551,200 lb

Operation

SH/LH+LF

+ 49.2-108.3 ft 31.5 ft 32.2 ft/s 360° ASME B30.5														
295.3 ft														
49.2 ft			68.9 ft				88.6 ft			108.3 ft				
15°		20°	30°	15°	20°	30°	15°	20°	30°	15°	20°	30°	ft	
ft													1,000 lb	ft
52.5	480.6	-	-	-	-	-	-	-	-	-	-	-	52.5	
55.8	463.0	454.2	-	-	-	-	-	-	-	-	-	-	55.8	
59.1	437.6	436.5	-	392.4	-	-	-	-	-	-	-	-	59.1	
62.3	412.3	418.9	330.7	392.4	363.8	-	-	-	-	-	-	-	62.3	
65.6	391.3	396.8	330.7	380.3	363.8	-	321.9	-	-	-	-	-	65.6	
72.2	352.7	357.1	329.2	351.3	350.5	-	318.6	293.2	-	260.1	-	-	72.2	
75.5	335.1	339.5	327.8	334.4	337.3	255.7	316.9	293.2	-	260.1	-	-	75.5	
78.7	317.5	321.9	326.3	317.5	324.1	253.5	315.3	293.2	-	260.1	238.1	-	78.7	
85.3	291.0	295.4	300.9	291.0	296.5	246.9	289.9	282.2	188.5	260.1	235.9	-	85.3	
91.9	264.6	269.0	275.6	264.6	269.0	240.3	264.6	271.2	186.3	260.1	233.7	-	91.9	
95.1	254.1	258.5	264.6	254.1	258.5	237.0	254.1	270.2	183.5	250.8	229.6	147.7	95.1	
98.4	243.6	248.0	253.5	243.6	248.0	233.7	243.6	250.2	180.8	241.4	225.4	145.5	98.4	
111.5	206.7	210.0	215.0	206.7	210.5	214.4	207.2	212.7	170.9	206.7	206.7	137.2	111.5	
124.7	176.9	179.1	184.1	176.9	180.2	187.4	178.0	182.4	162.6	177.5	183.0	130.1	124.7	
137.8	151.8	154.0	158.0	152.5	155.4	161.7	153.6	157.6	153.6	153.6	158.7	123.8	137.8	
150.9	129.0	131.2	134.5	131.2	133.4	138.9	132.3	135.6	143.3	132.3	136.7	117.9	150.9	
164.0	109.0	110.9	114.2	111.2	113.7	118.6	113.5	116.8	123.5	114.5	118.6	112.8	164.0	
177.2	91.1	92.7	96.0	93.2	95.8	100.2	96.0	99.2	105.1	97.4	101.3	103.9	177.2	
190.3	75.6	77.2	79.8	77.6	79.8	83.8	80.0	82.9	88.2	81.1	84.7	91.3	190.3	
203.4	63.3	64.7	67.0	65.0	67.0	70.3	67.2	69.7	74.1	68.2	71.1	77.3	203.4	
216.5	52.2	53.3	55.1	53.5	55.1	58.4	55.6	57.9	62.3	56.4	59.3	65.0	216.5	
229.7	42.3	43.4	45.2	43.7	45.2	47.8	45.6	47.6	51.4	46.3	48.9	53.8	229.7	
242.8	34.0	35.1	36.7	35.3	36.7	39.0	37.1	38.9	42.4	37.6	40.0	44.3	242.8	
255.9	26.6	27.4	28.7	27.6	28.7	30.9	29.1	30.9	34.0	29.5	31.7	35.8	255.9	
262.5	23.2	24.0	25.1	24.2	25.3	27.2	25.7	27.3	30.0	26.0	28.0	31.9	262.5	
269.0	19.8	20.5	-	20.7	21.8	23.6	22.3	23.8	26.5	22.5	24.5	28.0	269.0	
282.2	14.3	14.8	-	14.8	15.8	17.2	16.2	17.6	20.0	16.5	18.2	21.4	282.2	
288.7	11.5	11.9	-	11.9	12.8	-	13.2	14.6	16.8	13.4	15.0	18.1	288.7	
292.0	-	-	-	-	11.5	-	11.9	13.2	15.3	11.9	13.7	16.6	292.0	
295.3	-	-	-	-	-	-	-	11.9	13.9	-	12.3	15.2	295.3	
301.8	-	-	-	-	-	-	-	-	11.0	-	-	12.3	301.8	

286,600 lb 374,800 lb 463,000 lb 551,200 lb

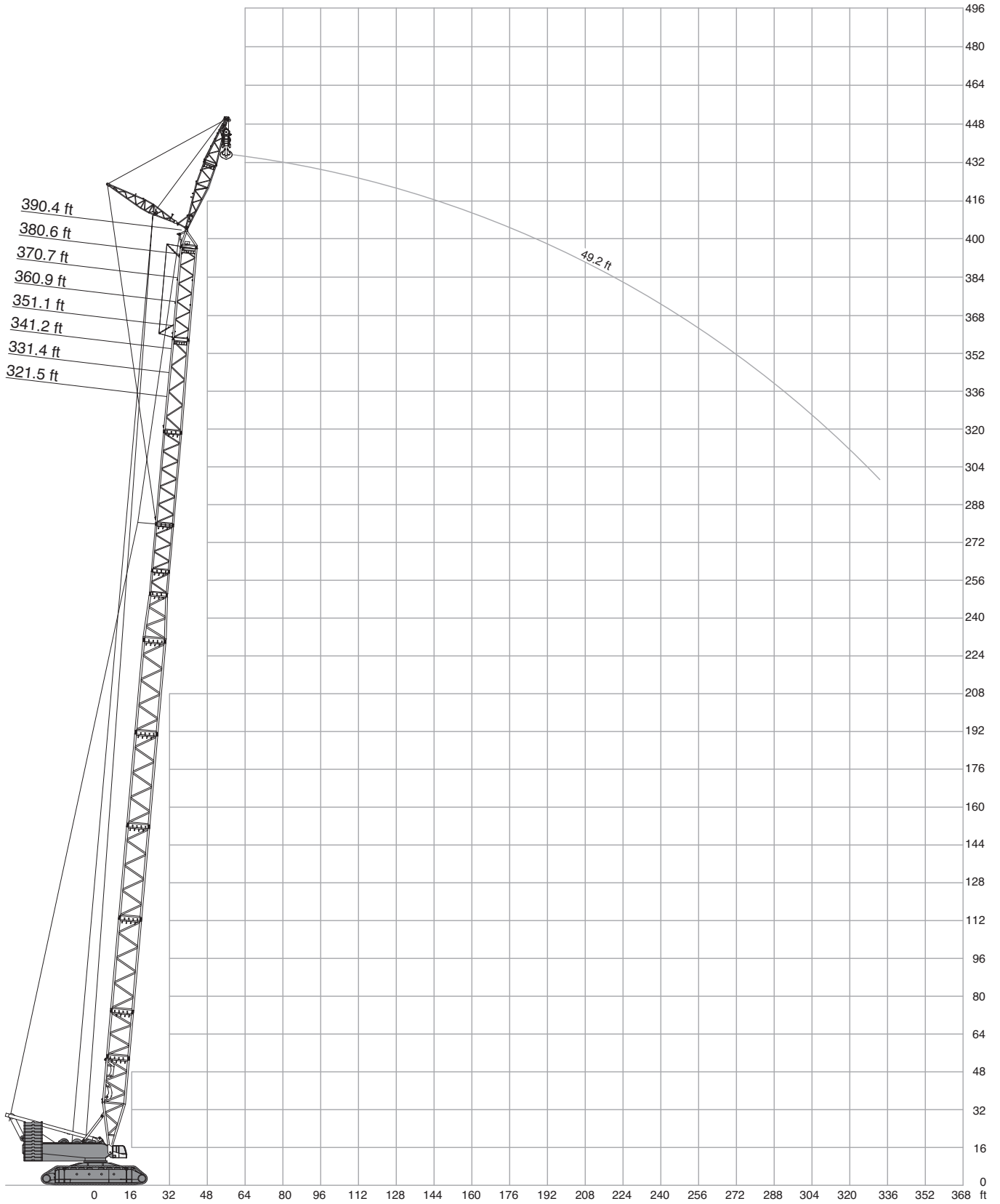

Operation

SH/LH+LF3_S3

		49.2-68.9 ft				31.5 ft				32.2 ft/s				360°				ASME B30.5			
		321.5 ft				331.4 ft				341.2 ft				351.1 ft							
		49.2 ft		68.9 ft		49.2 ft		68.9 ft		49.2 ft		68.9 ft		49.2 ft		68.9 ft					
		15°	20°	15°	20°	15°	20°	15°	20°	15°	20°	15°	20°	15°	20°	15°	20°				
ft		1,000 lb																ft			
52.5	385.8	-	-	-	-	370.4	-	-	-	357.1	-	-	-	339.5	-	-	-	-	52.5		
55.8	377.0	315.3	-	-	-	366.0	313.1	-	-	352.7	308.6	-	-	335.1	-	-	-	-	55.8		
59.1	368.2	308.6	269.0	-	-	361.6	308.6	269.0	-	346.1	308.6	269.0	-	330.7	302.0	260.1	-	-	59.1		
62.3	359.4	302.0	262.4	205.0	-	357.1	302.0	262.4	-	341.7	302.0	262.4	-	326.3	297.6	257.9	-	-	62.3		
65.6	352.7	295.4	255.7	205.0	350.5	295.4	255.7	202.8	335.1	297.6	257.9	205.0	321.9	293.2	253.5	202.8	-	-	65.6		
72.2	337.3	284.4	244.7	196.2	335.1	284.4	244.7	196.2	324.1	286.6	246.9	196.2	313.1	284.4	244.7	196.2	-	-	72.2		
78.7	321.9	273.4	233.7	189.6	317.5	273.4	233.7	189.6	310.9	275.6	235.9	189.6	302.0	275.6	235.9	189.6	-	-	78.7		
85.3	295.4	264.6	224.9	183.0	291.0	264.6	224.9	183.0	286.6	266.8	227.1	183.0	282.2	266.8	227.1	183.0	-	-	85.3		
91.9	271.2	253.5	216.1	176.4	266.8	253.5	216.1	176.4	262.4	255.7	218.3	176.4	257.9	253.5	218.3	176.4	-	-	91.9		
98.4	251.3	244.7	207.2	169.8	246.9	244.7	207.2	169.8	242.5	244.7	209.4	172.0	238.1	240.3	209.4	172.0	-	-	98.4		
111.5	213.8	218.3	191.8	158.7	211.6	213.8	191.8	158.7	207.2	211.6	194.0	160.9	205.0	207.2	196.2	160.9	-	-	111.5		
124.7	185.2	187.4	178.6	149.9	183.0	185.2	180.8	149.9	178.6	183.0	180.8	152.1	176.4	178.6	178.6	152.1	-	-	124.7		
137.8	163.1	165.3	163.1	142.2	158.7	160.9	160.9	142.2	156.5	158.7	158.7	143.3	153.2	155.4	155.4	143.3	-	-	137.8		
150.9	142.2	144.4	144.4	134.5	138.9	141.1	141.1	135.6	136.7	138.9	138.9	135.6	134.5	135.6	135.6	134.5	-	-	150.9		
164.0	123.5	124.6	126.8	125.7	121.3	122.4	124.6	125.7	119.0	121.3	122.4	124.6	116.8	117.9	117.9	121.3	-	-	164.0		
177.2	105.8	106.9	111.3	113.5	103.6	104.7	109.1	111.3	102.5	104.7	106.9	109.1	100.3	102.5	103.6	105.8	-	-	177.2		
190.3	90.4	92.6	95.9	98.1	88.2	90.4	93.7	95.9	88.2	89.3	92.6	94.8	86.0	87.1	90.4	92.6	-	-	190.3		
203.4	78.5	80.1	82.3	84.5	76.1	77.2	80.1	82.3	75.7	76.1	80.1	82.3	72.8	72.8	77.2	79.8	-	-	203.4		
216.5	66.1	68.3	70.5	72.8	63.9	66.1	68.3	70.5	63.9	63.9	68.3	70.5	61.7	61.7	66.1	68.3	-	-	216.5		
229.7	57.3	58.1	61.7	63.9	55.1	55.9	59.5	61.7	53.6	55.1	58.1	60.4	50.7	52.9	55.9	58.1	-	-	229.7		
242.8	48.5	50.0	52.9	55.1	47.0	48.5	50.7	52.9	44.8	47.0	50.0	50.7	42.6	44.8	48.5	48.5	-	-	242.8		
255.9	41.9	41.9	46.3	46.3	39.7	39.7	44.1	44.1	37.5	39.7	41.9	44.1	35.3	37.5	39.7	41.9	-	-	255.9		
269.0	34.5	36.0	38.9	40.4	32.3	33.8	36.7	38.2	31.6	32.3	36.0	36.7	28.7	30.4	33.8	34.5	-	-	269.0		
282.2	29.4	29.8	32.3	34.5	27.3	26.5	29.8	31.7	25.7	25.1	30.1	29.8	23.5	23.5	27.3	28.7	-	-	282.2		
295.3	24.3	24.3	26.5	28.7	22.0	22.0	24.3	26.5	19.8	19.8	24.3	24.3	17.6	17.6	22.0	22.0	-	-	295.3		
308.4	19.8	19.8	22.0	22.5	17.6	17.6	19.8	20.6	15.4	15.4	18.4	19.8	13.2	13.2	16.2	17.6	-	-	308.4		
315.0	17.6	17.6	19.8	19.8	15.4	15.4	17.6	17.6	13.2	13.2	15.4	17.6	11.0	11.0	13.2	15.4	-	-	315.0		
318.2	16.5	-	18.7	18.7	14.3	14.3	16.5	16.5	12.1	12.5	14.6	16.5	-	11.0	12.5	14.3	-	-	318.2		
321.5	15.4	-	17.6	17.6	13.2	13.2	15.4	15.4	11.0	11.8	13.7	15.4	-	-	11.8	13.2	-	-	321.5		
324.8	14.3	-	16.5	16.5	12.1	-	14.3	14.3	-	11.0	12.8	14.3	-	-	11.0	12.1	-	-	324.8		
328.1	13.2	-	15.4	15.4	11.0	-	13.2	13.2	-	-	11.9	13.2	-	-	-	11.0	-	-	328.1		
331.4	-	-	14.3	-	-	-	-	-	-	-	11.0	12.1	-	-	-	-	-	-	331.4		
334.6	-	-	13.2	-	-	-	-	-	-	-	-	11.0	-	-	-	-	-	-	334.6		
337.9	-	-	12.1	-	-	-	-	-	-	-	-	-	-	-	-	-	-	-	337.9		
341.2	-	-	11.0	-	-	-	-	-	-	-	-	-	-	-	-	-	-	-	341.2		

286,600 lb 374,800 lb 463,000 lb 551,250 lb

Operation

SH/LH+LF3_S3

49.2-68.9 ft 31.5 ft 32.2 ft/s 360° ASME B30.5													
360.9 ft				370.7 ft				380.6 ft		390.4 ft			
49.2 ft		68.9 ft		49.2 ft		68.9 ft		49.2 ft					
15°		20°		15°		20°		15°		20°		15°	
ft	1,000 lb												ft
55.8	317.5	-	-	-	302.0	-	-	-	291.0	-	277.8	-	55.8
59.1	313.1	299.8	-	-	295.4	291.0	-	-	284.4	273.4	271.2	-	59.1
62.3	308.6	295.4	260.1	-	291.0	286.6	253.5	-	280.0	273.4	266.8	257.9	62.3
65.6	304.2	291.0	255.7	205.0	284.4	284.4	249.1	-	273.4	269.0	262.4	253.5	65.6
68.9	299.8	287.7	252.4	202.8	280.0	281.1	246.9	205.0	269.0	265.7	257.9	251.3	68.9
72.2	295.4	284.4	249.1	200.6	275.6	277.8	244.7	200.6	264.6	262.4	253.5	249.1	72.2
78.7	288.8	277.8	242.5	194.0	266.8	269.0	238.1	196.2	255.7	255.7	244.7	242.5	78.7
85.3	277.8	269.0	235.9	187.4	257.9	260.1	233.7	189.6	249.1	249.1	238.1	238.1	85.3
91.9	255.7	260.1	229.3	183.0	246.9	251.3	227.1	183.0	238.1	242.5	229.3	231.5	91.9
98.4	235.9	238.1	220.5	176.4	231.5	233.7	220.5	178.6	227.1	231.5	218.3	224.9	98.4
111.5	202.8	205.0	202.8	167.6	198.4	200.6	198.4	167.6	194.0	198.4	191.8	194.0	111.5
124.7	174.2	176.4	176.4	156.5	169.8	174.2	172.0	158.7	167.6	169.8	165.3	167.6	124.7
137.8	152.1	154.3	153.2	148.8	148.8	151.0	149.9	148.8	146.6	148.8	142.2	144.4	137.8
150.9	132.3	134.5	134.5	135.6	130.1	131.2	130.1	134.5	127.9	129.0	123.5	125.7	150.9
164.0	115.7	117.9	117.9	120.2	113.5	113.5	114.6	117.9	111.3	111.3	106.9	109.1	164.0
177.2	100.3	101.4	103.6	105.8	98.1	98.1	101.4	103.6	95.9	97.0	92.6	94.8	177.2
190.3	84.9	86.0	90.4	92.6	82.7	83.8	88.2	90.4	80.8	83.8	79.4	81.6	190.3
203.4	72.3	72.8	77.2	79.8	69.8	71.9	75.7	77.2	69.1	71.3	66.9	69.1	203.4
216.5	61.7	61.7	66.1	68.3	59.5	59.5	63.9	66.1	57.3	59.5	55.1	57.3	216.5
229.7	50.7	52.9	55.9	58.1	48.5	50.7	53.4	55.9	48.5	48.5	46.3	46.3	229.7
242.8	42.6	44.1	46.7	48.5	40.4	41.9	44.8	47.0	39.7	40.4	37.5	38.2	242.8
255.9	35.3	35.3	39.7	39.7	33.1	33.1	37.5	39.7	30.9	33.1	28.7	30.9	255.9
269.0	28.7	28.7	32.3	33.8	25.4	27.2	30.4	32.3	25.6	25.4	22.8	23.5	269.0
282.2	23.5	23.5	26.9	26.5	19.8	21.3	23.5	25.7	19.1	19.1	16.9	16.9	282.2
295.3	17.6	17.6	19.8	22.0	15.4	15.4	17.6	19.8	13.2	13.2	11.0	11.0	295.3
298.6	16.5	16.5	18.7	20.6	14.0	14.3	16.5	18.4	12.1	12.5	-	11.0	298.6
301.8	15.4	15.4	17.6	19.1	12.5	13.2	15.4	16.9	11.0	11.8	-	-	301.8
305.1	14.3	14.3	16.5	17.6	11.0	12.1	14.3	15.4	-	11.0	-	-	305.1
308.4	13.2	13.2	15.4	16.2	-	11.0	13.2	14.0	-	-	-	-	308.4
315.0	11.0	11.0	13.2	13.2	-	-	11.0	11.0	-	-	-	-	315.0
318.2	-	-	12.5	12.5	-	-	11.0	11.0	-	-	-	-	318.2
321.5	-	-	11.8	11.8	-	-	-	-	-	-	-	-	321.5
324.8	-	-	11.0	11.0	-	-	-	-	-	-	-	-	324.8

	286,600 lb	374,800 lb	463,000 lb	551,250 lb
--	------------	------------	------------	------------

Operation

SSL+LF, SSL/LSL+LF
SSL/LSL S1+LF

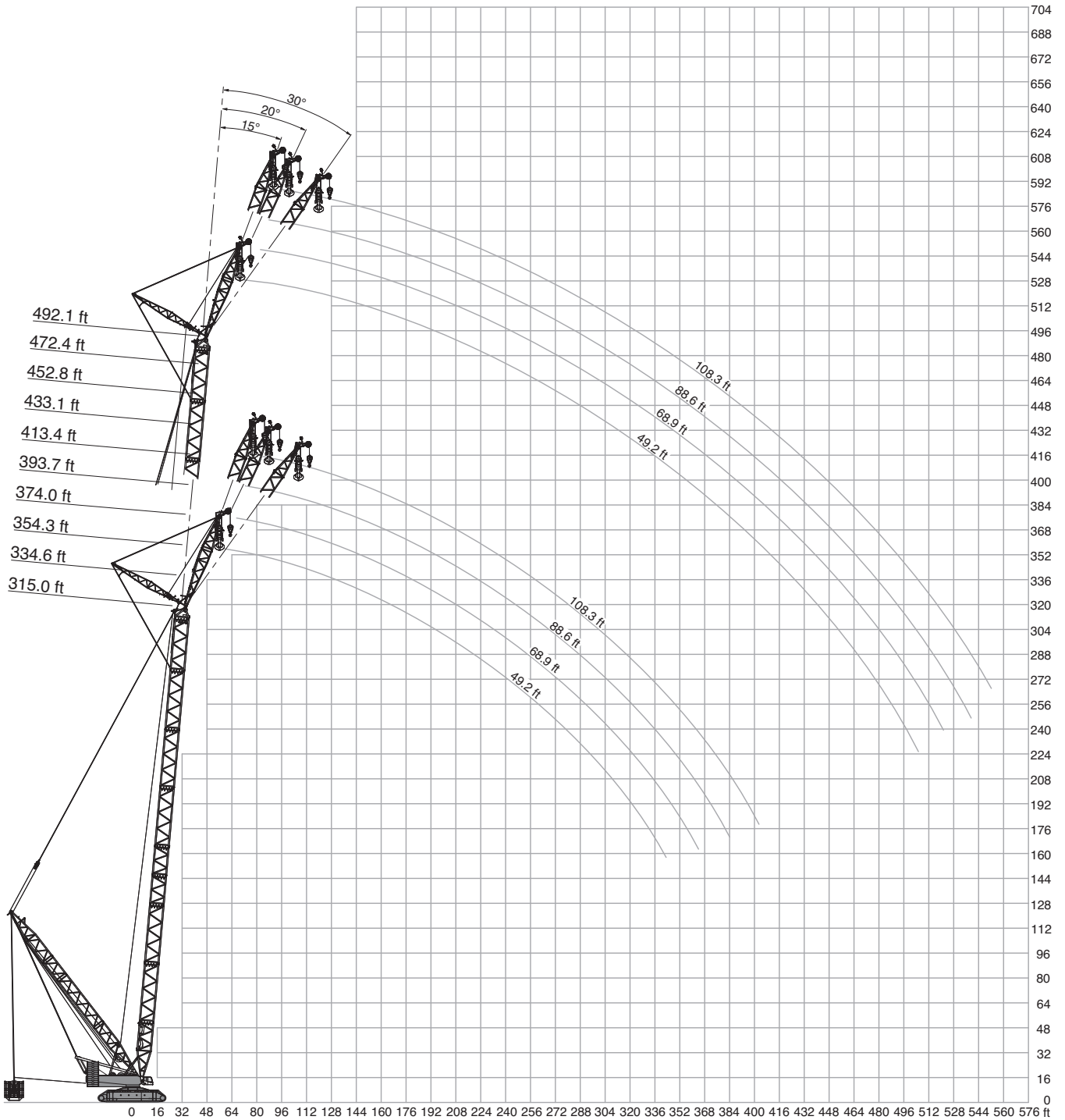

Operation

SSL+LF

551,200 lb + 176,400 lb 49.2-108.3 ft 49.2-78.7 ft 31.5 ft 32.2 ft/s 360° ASME B30.5																				
216.5 ft																				
49.2 ft					68.9 ft					88.6 ft					108.3 ft					
0 lb					0 - 992,100 lb					0 lb					0 - 992,100 lb					
15°			20°		30°		15°			20°		30°		15°			20°		30°	
1,000 lb																				
45.9	551.2	551.2	-	-	-	-	-	-	-	-	-	-	-	-	-	-	-	-	45.9	
49.2	551.2	551.2	551.2	-	-	-	-	-	-	-	-	-	-	-	-	-	-	-	49.2	
52.5	551.2	551.2	551.2	-	520.3	526.9	-	-	-	-	-	-	-	-	-	-	-	-	52.5	
55.8	551.2	551.2	551.2	352.7	520.3	526.9	-	-	-	-	-	-	-	-	-	-	-	-	55.8	
59.1	551.2	551.2	544.5	352.7	507.1	513.7	412.3	-	394.6	410.1	-	-	-	-	-	-	-	-	59.1	
65.6	511.5	551.2	524.7	343.9	478.4	485.0	394.6	-	394.6	399.0	313.1	-	315.3	326.3	-	-	-	-	65.6	
68.9	486.1	551.2	512.6	339.5	466.3	472.9	385.8	249.1	383.6	388.0	309.7	-	315.3	321.9	-	-	-	-	68.9	
72.2	460.8	551.2	500.4	335.1	454.2	460.8	377.0	249.1	372.6	377.0	306.4	-	315.3	317.5	-	-	-	-	72.2	
75.5	438.7	551.2	490.5	330.7	434.3	449.7	369.3	244.7	363.8	368.2	299.8	-	307.5	309.7	244.7	-	-	-	75.5	
78.7	416.7	551.2	480.6	326.3	414.5	438.7	361.6	240.3	354.9	359.4	293.2	189.6	299.8	302.0	244.7	-	-	-	78.7	
85.3	374.8	549.0	463.0	317.5	377.0	416.7	346.1	233.7	339.5	341.7	280.0	186.3	284.4	286.6	233.7	-	-	-	85.3	
91.9	335.1	542.3	445.3	308.6	341.7	399.0	332.9	227.1	324.1	326.3	269.0	180.8	271.2	273.4	224.9	146.6	-	-	91.9	
98.4	313.1	520.3	429.9	302.0	306.4	383.6	321.9	220.5	308.6	313.1	257.9	175.3	260.1	262.4	216.1	144.4	-	-	98.4	
111.5	255.7	478.4	401.2	286.6	260.1	352.7	299.8	209.4	257.9	286.6	238.1	166.4	238.1	240.3	198.4	135.6	-	-	111.5	
124.7	212.7	443.1	377.0	273.4	218.3	328.5	280.0	198.4	222.7	264.6	220.5	156.5	220.5	220.5	184.1	126.8	-	-	124.7	
137.8	178.6	414.5	356.0	261.2	183.5	305.3	262.4	190.1	188.5	244.7	207.2	148.3	191.3	203.9	171.4	120.2	-	-	137.8	
150.9	150.5	390.2	337.3	251.3	154.9	286.6	246.9	182.4	159.8	228.2	194.6	141.1	162.0	189.6	160.4	113.5	-	-	150.9	
164.0	127.3	369.3	321.9	243.6	131.2	269.0	233.7	175.3	135.6	213.3	183.5	135.0	137.8	176.9	150.5	107.9	-	-	164.0	
177.2	107.8	349.4	307.5	237.0	111.2	253.5	221.6	168.7	115.5	200.6	173.6	129.5	117.7	165.3	141.6	103.3	-	-	177.2	
190.3	90.9	331.8	294.3	230.4	94.5	240.3	211.1	162.6	98.5	189.6	164.8	124.6	100.6	155.4	134.5	98.9	-	-	190.3	
203.4	76.4	316.4	283.3	225.6	79.8	228.2	202.3	157.6	83.7	179.7	157.6	120.2	85.6	147.2	127.9	95.0	-	-	203.4	
206.7	73.0	312.5	280.5	224.9	76.4	225.4	200.3	156.5	80.2	177.5	156.0	119.0	82.2	145.2	126.2	94.1	-	-	206.7	
216.5	63.8	303.1	273.4	-	67.0	217.7	194.6	153.8	70.7	170.9	151.0	116.3	72.5	139.4	121.8	91.6	-	-	216.5	
226.4	55.4	294.9	266.8	-	58.4	210.8	189.3	151.0	61.9	164.8	146.3	113.8	63.7	134.2	117.9	89.3	-	-	226.4	
229.7	52.8	292.1	264.6	-	55.8	208.9	187.9	-	59.3	163.1	145.0	113.0	61.0	132.8	116.8	88.6	-	-	229.7	
232.9	50.2	289.4	262.4	-	53.1	207.0	186.6	-	56.7	161.5	143.6	112.2	58.3	131.5	115.7	88.0	-	-	232.9	
242.8	43.0	282.2	-	-	45.9	201.2	182.4	-	49.3	156.5	140.0	110.6	50.8	127.3	112.4	86.2	-	-	242.8	
246.1	-	-	-	-	43.5	199.2	181.1	-	46.9	154.9	138.9	110.2	48.4	125.9	111.3	85.6	-	-	246.1	
252.6	-	-	-	-	39.2	195.9	178.6	-	42.4	151.8	136.7	-	44.0	123.2	109.3	84.7	-	-	252.6	
255.9	-	-	-	-	37.1	194.6	-	-	40.3	150.5	135.6	-	41.9	121.8	108.5	84.2	-	-	255.9	
262.5	-	-	-	-	33.1	191.8	-	-	36.2	147.7	133.4	-	37.7	119.0	106.7	83.3	-	-	262.5	
265.7	-	-	-	-	-	-	-	-	34.3	146.6	132.6	-	35.8	117.9	105.9	82.9	-	-	265.7	
269.0	-	-	-	-	-	-	-	-	32.4	145.5	131.9	-	33.8	116.8	105.2	-	-	-	269.0	
272.3	-	-	-	-	-	-	-	-	30.5	144.4	131.2	-	31.9	115.7	104.4	-	-	-	272.3	
282.2	-	-	-	-	-	-	-	-	25.1	142.2	-	-	26.6	113.0	102.4	-	-	-	282.2	
288.7	-	-	-	-	-	-	-	-	-	-	-	-	23.1	111.3	101.2	-	-	-	288.7	
295.3	-	-	-	-	-	-	-	-	-	-	-	-	20.1	110.5	-	-	-	-	295.3	
298.6	-	-	-	-	-	-	-	-	-	-	-	-	18.5	110.0	-	-	-	-	298.6	

	0 lb	176,400 lb	352,800 lb	529,200 lb	705,600 lb	882,000 lb	992,100 lb
--	------	------------	------------	------------	------------	------------	------------

Operation

SSL+LF

551,200 lb + 176,400 lb 49.2-108.3 ft 49.2-78.7 ft 31.5 ft 32.2 ft/s 360° ASME B30.5																	
236.2 ft																	
49.2 ft			68.9 ft				88.6 ft			108.3 ft							
0 lb			0 - 992,100 lb				0 lb			0 - 992,100 lb							
15°			20°		30°		15°		20°		30°		15°		30°		
ft	1,000 lb															ft	
45.9	551.2	551.2	-	-	-	-	-	-	-	-	-	-	-	-	-	45.9	
52.5	551.2	551.2	551.2	-	511.5	535.7	-	-	-	-	-	-	-	-	-	52.5	
59.1	551.2	551.2	549.0	348.3	511.5	520.3	407.9	-	399.0	403.4	-	-	-	-	-	59.1	
65.6	493.8	551.2	533.5	343.9	485.0	491.6	399.0	-	399.0	403.4	-	-	317.5	321.9	-	65.6	
68.9	468.5	551.2	522.5	340.6	463.0	480.6	390.2	249.1	389.1	393.5	308.6	-	317.5	321.9	-	68.9	
72.2	443.1	551.2	511.5	337.3	440.9	469.6	381.4	249.1	379.2	383.6	308.6	-	317.5	321.9	-	72.2	
75.5	422.2	551.2	501.6	332.9	420.0	458.6	373.7	245.8	370.4	374.8	302.0	-	309.7	314.2	242.5	75.5	
78.7	401.2	551.2	491.6	328.5	399.0	447.5	366.0	242.5	361.6	366.0	295.4	-	302.0	306.4	242.5	78.7	
82.0	382.5	550.1	481.7	325.2	381.4	437.6	359.4	239.2	352.7	357.1	289.9	188.5	295.4	298.7	239.2	82.0	
85.3	363.8	549.0	471.8	321.9	363.8	427.7	352.7	235.9	343.9	348.3	284.4	188.5	288.8	291.0	235.9	85.3	
91.9	326.3	546.7	456.4	313.1	332.9	410.1	339.5	229.3	330.7	332.9	273.4	183.0	275.6	280.0	227.1	145.5	91.9
98.4	304.2	535.7	440.9	306.4	299.8	392.4	328.5	222.7	306.4	319.7	264.6	177.5	264.6	266.8	219.4	145.5	98.4
111.5	249.1	496.0	412.3	291.0	253.5	363.8	306.4	212.7	249.1	295.4	244.7	168.7	244.7	246.9	202.8	136.7	111.5
124.7	205.0	460.8	388.0	277.8	210.5	339.5	288.8	202.8	216.1	273.4	227.1	159.8	210.5	227.1	188.5	129.0	124.7
137.8	170.9	431.0	367.1	267.9	175.8	316.4	270.1	193.5	181.3	253.5	213.3	151.6	184.6	210.5	175.8	121.3	137.8
150.9	142.7	404.5	348.3	257.9	147.2	296.5	254.6	185.7	152.1	235.9	200.6	144.4	155.4	195.7	164.8	115.2	150.9
164.0	119.5	383.6	331.8	249.1	123.5	278.9	240.3	178.6	127.9	221.0	189.6	137.8	131.2	182.4	154.9	110.0	164.0
177.2	99.8	364.9	317.5	241.4	103.5	263.5	228.2	172.5	107.9	208.9	179.7	131.7	110.8	171.4	146.1	105.2	177.2
190.3	82.9	346.1	305.3	234.8	86.6	249.1	218.3	166.4	90.9	197.3	170.9	126.8	93.4	161.5	138.3	100.6	190.3
203.4	68.3	329.6	294.3	229.3	71.9	237.0	209.4	160.9	75.9	186.8	162.6	122.4	78.3	152.7	131.7	96.8	203.4
216.5	55.7	315.3	283.3	224.9	59.1	227.1	201.2	156.5	62.9	177.5	155.4	118.5	65.0	145.0	125.7	93.4	216.5
223.1	49.8	308.6	277.8	222.7	53.1	222.7	197.3	154.3	56.9	173.1	152.1	116.8	58.9	141.1	122.4	91.7	223.1
229.7	44.6	303.1	273.4	-	47.8	217.7	194.0	152.7	51.5	169.8	149.4	115.2	53.5	137.8	120.2	90.3	229.7
242.8	34.8	292.1	265.7	-	37.8	208.9	187.9	149.9	41.3	163.1	144.4	112.4	43.2	131.7	115.7	87.6	242.8
249.3	30.2	286.6	262.4	-	33.1	205.0	185.2	-	36.6	159.8	142.2	111.3	38.4	129.0	113.5	86.4	249.3
255.9	26.1	273.4	-	-	29.0	201.7	182.4	-	32.4	156.5	140.0	110.3	34.1	126.2	111.7	85.4	255.9
259.2	24.0	266.8	-	-	27.0	200.1	181.1	-	30.3	154.9	138.9	109.8	31.9	124.8	110.7	84.9	259.2
269.0	-	-	-	-	21.2	195.7	178.6	-	24.4	151.0	135.6	-	26.0	121.3	108.0	83.6	269.0
278.9	-	-	-	-	15.7	191.8	-	-	18.8	147.7	132.6	-	20.5	118.2	105.5	82.5	278.9
282.2	-	-	-	-	-	-	-	-	17.2	146.6	131.9	-	18.7	117.4	104.8	-	282.2
285.4	-	-	-	-	-	-	-	-	15.5	145.5	131.2	-	17.0	116.6	104.1	-	285.4
292.0	-	-	-	-	-	-	-	-	12.3	143.7	-	-	13.7	114.6	102.8	-	292.0
295.3	-	-	-	-	-	-	-	-	-	142.9	-	-	12.1	113.5	102.3	-	295.3
298.6	-	-	-	-	-	-	-	-	-	142.2	-	-	-	112.4	101.7	-	298.6
305.1	-	-	-	-	-	-	-	-	-	-	-	-	-	110.9	100.8	-	305.1
308.4	-	-	-	-	-	-	-	-	-	-	-	-	-	110.5	-	-	308.4
318.2	-	-	-	-	-	-	-	-	-	-	-	-	-	109.1	-	-	318.2

	0 lb	176,400 lb	352,800 lb	529,200 lb	705,600 lb	882,000 lb	992,100 lb
--	------	------------	------------	------------	------------	------------	------------

Operation

SSL+LF

551,200 lb + 176,400 lb 49.2-108.3 ft 49.2-78.7 ft 31.5 ft 32.2 ft/s 360° ASME B30.5																						
255.9 ft																						
49.2 ft				68.9 ft				88.6 ft				108.3 ft										
0 lb				0 - 992,100 lb				0 lb				0 - 992,100 lb										
15°				20°				30°				15°					20°			30°		
ft	1,000 lb																ft					
49.2	551.2	551.2	-	-	-	-	-	-	-	-	-	-	-	-	-	-	49.2					
52.5	551.2	551.2	551.2	-	-	-	-	-	-	-	-	-	-	-	-	-	52.5					
55.8	551.2	551.2	551.2	-	504.9	524.7	-	-	-	-	-	-	-	-	-	-	55.8					
59.1	533.5	551.2	551.2	348.3	504.9	524.7	-	-	-	-	-	-	-	-	-	-	59.1					
62.3	502.7	551.2	546.7	348.3	498.2	511.5	401.2	-	392.4	407.9	-	-	-	-	-	-	62.3					
65.6	476.2	551.2	537.9	346.1	471.8	498.2	401.2	-	392.4	407.9	-	-	-	-	-	-	65.6					
68.9	451.9	551.2	528.0	341.7	448.6	488.3	393.5	-	388.0	397.9	310.9	-	313.1	324.1	-	-	68.9					
72.2	427.7	551.2	518.1	337.3	425.5	478.4	385.8	246.9	383.6	388.0	310.9	-	313.1	324.1	-	-	72.2					
78.7	385.8	551.2	498.2	330.7	385.8	456.4	372.6	244.7	366.0	370.4	299.8	-	306.4	308.6	242.5	-	78.7					
82.0	368.2	551.2	489.4	327.4	368.2	446.4	364.9	241.4	358.3	362.7	293.2	186.3	299.8	302.0	240.3	-	82.0					
85.3	350.5	551.2	480.6	324.1	350.5	436.5	357.1	238.1	350.5	354.9	286.6	186.3	293.2	295.4	238.1	-	85.3					
91.9	319.7	546.7	465.2	317.5	319.7	416.7	346.1	231.5	321.9	339.5	277.8	184.1	280.0	282.2	229.3	-	91.9					
95.1	303.1	544.5	457.5	314.2	306.4	409.0	339.5	228.2	308.6	332.9	272.3	181.3	274.5	276.7	226.0	145.5	95.1					
98.4	286.6	542.3	449.7	310.9	293.2	401.2	332.9	224.9	295.4	326.3	266.8	178.6	269.0	271.2	222.7	145.5	98.4					
111.5	242.5	509.3	423.3	295.4	238.1	372.6	313.1	215.0	244.7	302.0	249.1	169.8	249.1	251.3	206.1	137.8	111.5					
124.7	198.4	474.0	399.0	284.4	203.9	348.3	295.4	205.0	210.5	280.0	233.7	162.0	205.0	233.7	191.8	130.1	124.7					
137.8	164.8	442.0	377.0	272.3	169.8	326.3	277.8	196.8	175.8	261.2	218.3	153.8	175.3	216.6	179.7	123.5	137.8					
150.9	136.1	416.7	357.1	262.4	141.1	306.4	262.4	189.0	146.6	243.6	205.6	146.6	149.4	201.7	168.7	116.8	150.9					
164.0	112.9	394.6	340.6	253.5	117.2	289.9	249.1	181.9	122.4	229.3	194.6	140.0	124.6	189.0	158.7	111.3	164.0					
177.2	93.1	377.0	326.3	245.8	97.2	274.5	237.0	175.8	102.0	216.1	184.6	133.9	104.4	177.5	149.9	106.8	177.2					
190.3	76.2	361.6	314.2	239.2	80.0	260.1	226.0	170.3	84.5	203.9	175.8	129.0	87.1	167.0	142.2	102.4	190.3					
203.4	61.5	345.0	303.1	233.7	65.3	246.9	216.1	164.8	69.4	193.5	168.1	124.6	71.9	158.2	135.6	98.4	203.4					
216.5	48.8	329.6	292.1	228.2	52.4	235.9	207.8	159.8	56.3	184.1	160.9	120.7	58.6	150.5	129.5	94.9	216.5					
229.7	37.7	316.4	282.2	223.8	41.0	226.0	200.1	156.0	44.9	175.8	154.3	117.4	47.0	143.3	124.0	91.8	229.7					
236.2	32.4	310.9	277.8	222.7	35.7	220.5	196.2	154.3	39.5	172.0	151.0	115.7	41.4	140.0	121.3	90.4	236.2					
242.8	27.9	303.1	273.4	-	31.0	216.6	193.5	152.7	34.7	168.7	148.3	114.1	36.6	136.7	119.0	89.1	242.8					
255.9	19.2	278.9	265.7	-	22.0	209.4	187.9	149.9	25.7	162.0	143.3	111.3	27.4	130.6	114.6	86.6	255.9					
265.7	13.1	255.7	255.7	-	15.9	204.5	184.1	-	19.5	157.6	140.3	109.9	21.2	126.8	111.6	85.0	265.7					
269.0	11.2	251.3	-	-	14.0	202.8	183.0	-	17.5	156.5	139.4	109.6	19.3	125.7	110.8	84.5	269.0					
272.3	-	246.9	-	-	12.1	201.2	181.9	-	15.6	154.9	138.6	109.2	17.4	124.6	110.0	84.1	272.3					
275.6	-	242.5	-	-	-	199.5	180.8	-	13.7	153.2	137.8	108.9	15.4	123.5	109.1	83.6	275.6					
278.9	-	-	-	-	-	198.1	179.7	-	11.9	152.1	136.7	-	13.7	122.4	108.4	83.2	278.9					
282.2	-	-	-	-	-	196.8	178.6	-	-	151.0	135.6	-	11.9	121.3	107.6	82.9	282.2					
285.4	-	-	-	-	-	195.4	177.5	-	-	149.9	134.5	-	-	120.2	106.8	82.6	285.4					
292.0	-	-	-	-	-	192.9	-	-	-	147.7	132.8	-	-	118.2	105.3	81.8	292.0					
295.3	-	-	-	-	-	191.8	-	-	-	146.6	132.3	-	-	117.4	104.6	-	295.3					
301.8	-	-	-	-	-	-	-	-	-	144.4	131.2	-	-	115.7	103.2	-	301.8					
308.4	-	-	-	-	-	-	-	-	-	142.7	-	-	-	114.1	102.1	-	308.4					
315.0	-	-	-	-	-	-	-	-	-	141.1	-	-	-	112.4	101.0	-	315.0					
321.5	-	-	-	-	-	-	-	-	-	-	-	-	-	111.1	100.1	-	321.5					
334.6	-	-	-	-	-	-	-	-	-	-	-	-	-	108.7	-	-	334.6					

	0 lb	176,400 lb	352,800 lb	529,200 lb	705,600 lb	882,000 lb	992,100 lb
--	------	------------	------------	------------	------------	------------	------------

Operation

SSL+LF

551,200 lb + 176,400 lb 49.2-108.3 ft 49.2-78.7 ft 31.5 ft 32.2 ft/s 360° ASME B30.5																		
275.6 ft																		
49.2 ft			68.9 ft			88.6 ft			108.3 ft									
0 lb			0 - 992,100 lb			0 lb			0 - 992,100 lb			0 lb						
15°			20°			30°			15°			20°			30°			
ft	1,000 lb														ft			
49.2	551.2	551.2	-	-	-	-	-	-	-	-	-	-	-	-	-	-	-	49.2
52.5	551.2	551.2	-	-	-	-	-	-	-	-	-	-	-	-	-	-	-	52.5
55.8	544.5	551.2	551.2	-	509.3	529.1	-	-	-	-	-	-	-	-	-	-	-	55.8
59.1	513.7	551.2	551.2	-	507.1	529.1	-	-	-	-	-	-	-	-	-	-	-	59.1
62.3	485.0	551.2	551.2	346.1	480.6	515.9	405.7	-	388.0	401.2	-	-	-	-	-	-	-	62.3
65.6	458.6	551.2	542.3	346.1	454.2	504.9	405.7	-	388.0	401.2	-	-	-	-	-	-	-	65.6
72.2	410.1	551.2	524.7	339.5	410.1	482.8	390.2	249.1	388.0	392.4	306.4	-	308.6	319.7	-	-	-	72.2
78.7	370.4	551.2	504.9	332.9	370.4	463.0	377.0	244.7	370.4	374.8	302.0	-	308.6	313.1	240.3	-	-	78.7
85.3	337.3	551.2	489.4	326.3	337.3	445.3	363.8	238.1	337.3	359.4	291.0	187.4	295.4	299.8	240.3	-	-	85.3
91.9	306.4	551.2	474.0	319.7	308.6	427.7	350.5	233.7	308.6	346.1	280.0	185.2	284.4	286.6	231.5	-	-	91.9
95.1	293.2	547.8	467.4	316.4	295.4	418.9	345.0	230.4	295.4	339.5	275.6	182.4	278.9	281.1	228.2	144.4	-	95.1
98.4	280.0	544.5	460.8	313.1	282.2	410.1	339.5	227.1	282.2	332.9	271.2	179.7	273.4	275.6	224.9	144.4	-	98.4
111.5	233.7	522.5	432.1	299.8	231.5	381.4	319.7	217.2	238.1	308.6	253.5	172.0	240.3	255.7	209.4	138.9	-	111.5
124.7	190.7	489.4	407.9	288.8	197.3	357.1	302.0	208.3	194.0	288.8	238.1	163.1	198.4	238.1	195.1	131.2	-	124.7
137.8	157.1	459.7	386.9	277.8	162.6	336.2	285.5	200.1	168.1	269.0	223.2	156.0	168.7	222.1	183.5	124.6	-	137.8
150.9	128.4	432.1	368.2	267.9	133.4	316.4	270.1	192.4	138.9	251.3	211.1	148.8	142.7	207.8	172.5	118.5	-	150.9
164.0	105.1	409.0	350.5	257.9	109.6	297.6	255.7	185.2	114.8	235.9	199.5	142.2	118.1	194.6	162.6	113.0	-	164.0
177.2	85.2	389.1	335.1	250.2	89.6	282.2	243.6	179.1	94.5	223.2	189.6	136.1	97.6	183.0	153.8	108.1	-	177.2
190.3	68.2	372.6	323.0	243.6	72.3	269.0	232.6	173.6	76.9	211.1	180.8	131.2	79.8	172.5	146.1	103.9	-	190.3
203.4	53.6	358.3	312.0	237.0	57.4	255.7	222.7	168.1	61.8	200.1	172.5	126.8	64.5	163.1	138.9	100.0	-	203.4
216.5	40.8	342.8	300.9	231.5	44.4	243.6	214.4	163.1	48.7	190.7	165.3	122.9	51.1	154.9	132.8	96.5	-	216.5
229.7	29.5	328.5	291.0	227.1	33.1	233.7	206.7	158.7	37.1	182.4	158.7	119.6	39.5	147.7	127.3	93.3	-	229.7
242.8	19.6	314.2	282.2	223.8	23.0	224.9	199.5	154.9	26.9	174.7	152.7	116.3	29.1	141.1	122.4	90.4	-	242.8
249.3	15.0	306.4	277.8	222.7	18.3	220.5	196.2	153.2	22.0	170.9	149.9	114.6	24.3	137.8	120.2	89.1	-	249.3
252.6	12.8	297.6	274.5	-	16.2	218.8	194.7	152.7	19.9	169.4	148.8	114.1	22.0	136.4	119.0	88.5	-	252.6
255.9	-	289.5	271.2	-	14.0	217.2	193.3	152.1	17.7	167.9	147.7	113.5	19.8	135.0	117.9	87.9	-	255.9
259.2	-	281.5	269.0	-	11.9	215.0	191.8	151.0	15.6	166.4	146.6	113.0	17.6	133.7	116.8	87.2	-	259.2
265.7	-	265.7	261.2	-	-	211.1	188.5	149.9	11.5	163.1	144.4	111.7	13.4	131.2	114.6	86.1	-	265.7
269.0	-	257.9	255.7	-	-	209.4	187.4	148.8	-	161.7	143.3	111.0	11.5	130.1	113.5	85.6	-	269.0
282.2	-	228.2	229.3	-	-	202.8	183.0	-	-	156.0	138.9	109.3	-	124.6	110.0	83.8	-	282.2
288.7	-	220.5	-	-	-	199.5	180.8	-	-	153.2	136.7	108.5	-	122.4	108.7	82.9	-	288.7
295.3	-	212.7	-	-	-	197.3	178.6	-	-	151.0	135.0	-	-	120.7	107.1	82.2	-	295.3
298.6	-	-	-	-	-	196.2	177.5	-	-	149.9	134.2	-	-	119.9	106.4	81.9	-	298.6
308.4	-	-	-	-	-	192.9	-	-	-	147.2	132.3	-	-	116.8	104.3	81.1	-	308.4
311.7	-	-	-	-	-	191.8	-	-	-	146.3	131.7	-	-	115.7	103.6	-	-	311.7
318.2	-	-	-	-	-	-	-	-	-	144.7	130.1	-	-	114.1	102.5	-	-	318.2
321.5	-	-	-	-	-	-	-	-	-	143.9	-	-	-	113.5	102.0	-	-	321.5
331.4	-	-	-	-	-	-	-	-	-	141.1	-	-	-	111.8	100.5	-	-	331.4
334.6	-	-	-	-	-	-	-	-	-	-	-	-	-	111.2	100.1	-	-	334.6
337.9	-	-	-	-	-	-	-	-	-	-	-	-	-	110.6	99.6	-	-	337.9
347.8	-	-	-	-	-	-	-	-	-	-	-	-	-	109.0	-	-	-	347.8
351.1	-	-	-	-	-	-	-	-	-	-	-	-	-	108.5	-	-	-	351.1

	0 lb	176,400 lb	352,800 lb	529,200 lb	705,600 lb	882,000 lb	992,100 lb
--	------	------------	------------	------------	------------	------------	------------

Operation

SSL+LF

551,200 lb + 176,400 lb 49.2-108.3 ft 49.2-78.7 ft 31.5 ft 32.2 ft/s 360° ASME B30.5																	
295.3 ft																	
49.2 ft			68.9 ft				88.6 ft			108.3 ft							
0 lb			0 - 992,100 lb				0 lb			0 - 992,100 lb							
15°			20°		30°		15°		20°		30°		15°		30°		
ft	1,000 lb															ft	
52.5	551.2	551.2	-	-	-	-	-	-	-	-	-	-	-	-	-	52.5	
55.8	524.7	551.2	549.0	-	-	-	-	-	-	-	-	-	-	-	-	55.8	
59.1	493.8	551.2	549.0	-	491.6	520.3	-	-	-	-	-	-	-	-	-	59.1	
62.3	465.2	551.2	549.0	346.1	463.0	520.3	-	-	-	-	-	-	-	-	-	62.3	
65.6	440.9	551.2	549.0	346.1	438.7	509.3	401.2	-	390.2	403.4	-	-	-	-	-	65.6	
72.2	394.6	551.2	529.1	339.5	394.6	487.2	392.4	-	390.2	394.6	308.6	-	310.9	315.3	-	72.2	
75.5	375.9	551.2	520.3	336.2	375.9	478.4	385.8	246.9	373.7	386.9	306.4	-	310.9	315.3	-	75.5	
78.7	357.1	551.2	511.5	332.9	357.1	469.6	379.2	246.9	357.1	379.2	304.2	-	310.9	315.3	-	78.7	
82.0	340.6	551.2	503.8	329.6	340.6	460.8	373.7	243.6	341.7	371.5	298.7	-	304.2	308.6	242.5	82.0	
85.3	324.1	551.2	496.0	326.3	324.1	451.9	368.2	240.3	326.3	363.8	293.2	186.3	297.6	302.0	242.5	85.3	
91.9	295.4	551.2	478.4	321.9	295.4	434.3	354.9	235.9	297.6	350.5	284.4	186.3	286.6	291.0	233.7	91.9	
98.4	269.0	549.0	465.2	315.3	271.2	416.7	343.9	229.3	273.4	337.3	275.6	180.8	273.4	280.0	227.1	145.5	98.4
111.5	218.3	533.5	438.7	304.2	224.9	390.2	324.1	219.4	231.5	315.3	257.9	173.1	231.5	260.1	212.7	140.0	111.5
124.7	184.1	500.4	416.7	293.2	190.7	366.0	306.4	210.5	188.5	293.2	242.5	165.3	192.9	242.5	198.4	132.3	124.7
137.8	150.5	471.8	395.7	282.2	156.0	343.9	291.0	202.3	157.6	275.6	228.2	157.6	162.0	228.2	186.8	125.7	137.8
150.9	121.8	445.3	375.9	272.3	126.8	324.1	276.7	195.1	132.3	259.0	215.0	151.0	136.7	213.3	175.8	119.6	150.9
164.0	98.3	421.1	358.3	262.4	103.0	306.4	262.4	188.5	108.2	243.6	204.5	144.4	112.2	200.1	165.9	114.1	164.0
177.2	78.4	400.1	343.9	254.6	83.0	291.0	250.2	182.4	88.0	229.3	194.6	138.3	91.4	188.5	157.1	109.5	177.2
190.3	61.3	382.5	330.7	248.0	65.6	277.8	239.2	176.4	70.3	217.2	185.2	133.4	73.5	178.0	149.4	105.5	190.3
203.4	46.5	368.2	319.7	241.4	50.6	264.6	229.3	170.9	55.1	206.7	176.9	129.0	58.1	168.7	142.2	101.4	203.4
216.5	33.7	354.9	310.9	235.9	37.6	252.4	220.5	165.9	41.9	197.3	169.8	124.6	44.6	160.4	136.1	97.8	216.5
229.7	22.5	338.4	300.9	231.5	26.1	242.5	212.2	160.9	30.3	188.5	163.1	120.7	32.8	152.7	130.6	94.6	229.7
242.8	12.6	315.3	291.0	227.8	16.0	233.0	205.0	157.3	20.1	180.4	157.1	117.4	22.5	145.5	125.1	91.7	242.8
249.3	-	304.2	286.6	224.9	11.2	227.1	201.7	155.4	15.2	176.4	154.3	115.7	17.6	142.2	122.4	90.4	249.3
252.6	-	298.2	284.4	224.3	-	225.4	200.1	154.9	13.0	175.3	153.2	115.4	15.3	141.1	121.3	89.8	252.6
255.9	-	292.1	282.2	223.8	-	223.8	198.4	154.3	-	173.4	151.8	115.0	13.0	139.6	120.2	89.2	255.9
262.5	-	280.0	277.8	222.7	-	220.5	195.1	152.1	-	169.8	148.8	113.5	-	136.7	117.9	88.0	262.5
269.0	-	265.7	265.7	-	-	216.6	192.4	151.0	-	167.0	146.6	112.4	-	133.9	116.3	86.9	269.0
282.2	-	238.1	239.2	-	-	209.4	187.4	148.8	-	161.5	142.2	110.5	-	129.0	112.4	84.8	282.2
295.3	-	211.6	212.4	-	-	203.4	183.0	-	-	156.0	138.3	108.8	-	124.6	109.1	83.0	295.3
298.6	-	205.0	206.1	-	-	202.0	181.9	-	-	154.6	137.5	108.4	-	123.5	108.6	82.6	298.6
301.8	-	200.6	-	-	-	200.6	180.8	-	-	153.2	136.7	108.0	-	122.4	108.0	82.2	301.8
308.4	-	194.0	-	-	-	195.1	179.1	-	-	151.0	135.2	-	-	120.2	106.6	81.7	308.4
311.7	-	190.7	-	-	-	192.4	178.3	-	-	149.9	134.5	-	-	119.0	105.9	81.4	311.7
315.0	-	-	-	-	-	189.6	177.5	-	-	148.8	133.4	-	-	117.9	105.2	81.1	315.0
321.5	-	-	-	-	-	183.0	-	-	-	147.2	132.6	-	-	116.8	103.9	80.5	321.5
331.4	-	-	-	-	-	172.0	-	-	-	144.7	130.6	-	-	114.1	102.2	-	331.4
334.6	-	-	-	-	-	-	-	-	-	143.9	130.1	-	-	113.5	101.7	-	334.6
347.8	-	-	-	-	-	-	-	-	-	141.1	-	-	-	111.2	100.0	-	347.8
354.3	-	-	-	-	-	-	-	-	-	-	-	-	-	110.0	99.2	-	354.3
360.9	-	-	-	-	-	-	-	-	-	-	-	-	-	109.0	-	-	360.9
367.5	-	-	-	-	-	-	-	-	-	-	-	-	-	108.0	-	-	367.5

	0 lb	176,400 lb	352,800 lb	529,200 lb	705,600 lb	882,000 lb	992,100 lb
--	------	------------	------------	------------	------------	------------	------------

Operation

SSL+LF

551,200 lb + 176,400 lb 49.2-108.3 ft 49.2-78.7 ft 31.5 ft 32.2 ft/s 360° ASME B30.5

315.0 ft

49.2 ft 68.9 ft 88.6 ft 108.3 ft

0 lb 0 - 992,100 lb 0 lb 0 - 992,100 lb 0 lb 0 - 992,100 lb 0 lb 0 - 992,100 lb

15° 20° 30° 15° 20° 30° 15° 20° 30° 15° 20° 30°

1,000 lb														
ft													ft	
52.5	535.7	551.2	-	-	-	-	-	-	-	-	-	-	-	52.5
59.1	474.0	551.2	549.0	-	471.8	511.5	-	-	-	-	-	-	-	59.1
65.6	423.3	551.2	546.7	343.9	423.3	511.5	403.4	-	-	-	-	-	-	65.6
68.9	401.2	551.2	540.1	342.8	401.2	501.6	400.1	-	383.6	399.0	-	-	-	68.9
72.2	379.2	551.2	533.5	341.7	379.2	491.6	396.8	-	381.4	399.0	-	-	-	72.2
75.5	360.5	551.2	525.8	338.4	361.6	482.8	390.2	244.7	362.7	391.3	306.4	-	306.4	75.5
78.7	341.7	551.2	518.1	335.1	343.9	474.0	383.6	244.7	343.9	383.6	306.4	-	306.4	78.7
82.0	326.3	551.2	510.4	331.8	327.4	465.2	377.0	243.6	328.5	375.9	300.9	-	303.1	82.0
85.3	310.9	551.2	502.7	328.5	310.9	456.4	370.4	242.5	313.1	368.2	295.4	-	299.8	85.3
88.6	296.5	551.2	494.9	326.3	297.6	448.6	364.9	239.2	299.8	361.6	291.0	186.3	293.2	88.6
91.9	282.2	551.2	487.2	324.1	284.4	440.9	359.4	235.9	286.6	354.9	286.6	186.3	286.6	91.9
98.4	257.9	551.2	474.0	317.5	257.9	423.3	348.3	231.5	262.4	341.7	277.8	181.9	262.4	98.4
111.5	211.6	537.9	447.5	308.6	218.3	396.8	328.5	220.5	220.5	319.7	262.4	174.2	220.5	111.5
124.7	177.5	511.5	423.3	295.4	175.3	372.6	310.9	212.7	181.9	299.8	246.9	166.4	186.3	124.7
137.8	142.7	481.7	402.3	285.5	148.3	351.6	296.5	205.6	151.0	282.2	232.6	159.3	151.6	137.8
150.9	114.1	455.3	383.6	275.6	119.5	331.8	282.2	197.9	125.7	265.7	219.9	152.1	125.7	150.9
164.0	90.5	429.9	367.1	266.8	95.7	314.2	269.0	191.3	101.3	250.2	209.4	146.1	104.8	164.0
177.2	70.4	409.0	351.6	259.0	75.3	298.7	256.8	185.2	80.6	235.9	199.0	140.5	84.2	177.2
190.3	53.4	391.3	337.3	252.4	57.9	284.4	245.8	179.1	62.8	223.8	189.6	135.6	66.2	190.3
203.4	38.6	377.0	325.2	245.8	42.9	271.2	234.8	173.6	47.6	213.3	181.3	131.2	50.8	203.4
216.5	25.7	359.4	315.3	240.3	29.8	260.1	224.9	168.7	34.4	203.4	174.2	126.8	37.3	216.5
229.7	14.3	335.1	307.9	235.9	18.2	250.2	217.5	164.2	22.7	194.0	167.6	122.9	25.4	229.7
232.9	11.7	328.5	306.4	234.8	15.5	247.5	216.1	163.1	20.0	191.8	165.9	122.1	22.6	232.9
236.2	-	321.9	304.2	233.7	12.8	244.7	213.8	162.0	17.2	189.6	164.2	121.3	19.8	236.2
242.8	-	309.7	298.7	231.5	-	240.3	210.5	159.8	12.1	186.3	161.3	119.8	14.8	242.8
246.1	-	303.7	296.0	230.4	-	238.1	208.9	158.7	-	184.1	159.8	119.0	12.3	246.1
255.9	-	286.6	284.4	227.1	-	231.5	203.9	156.0	-	178.6	155.4	116.3	-	255.9
269.0	-	265.7	266.8	222.7	-	223.2	197.3	153.2	-	172.0	150.5	113.5	-	269.0
278.9	-	249.1	251.3	220.5	-	217.7	192.9	151.3	-	167.3	146.6	111.9	-	278.9
282.2	-	242.5	244.7	-	-	216.1	191.8	150.5	-	165.9	145.5	111.3	-	282.2
295.3	-	217.2	218.8	-	-	209.4	187.4	147.7	-	160.4	141.8	109.6	-	295.3
308.4	-	192.9	194.4	-	-	200.6	183.0	-	-	155.4	138.3	108.2	-	308.4
311.7	-	186.8	188.5	-	-	197.9	181.9	-	-	154.3	137.5	107.8	-	311.7
315.0	-	180.8	-	-	-	195.1	180.8	-	-	153.2	136.7	107.4	-	315.0
321.5	-	174.7	-	-	-	184.1	178.0	-	-	151.0	135.0	-	-	321.5
328.1	-	168.7	-	-	-	173.1	175.3	-	-	148.8	133.4	-	-	328.1
331.4	-	-	-	-	-	168.1	169.8	-	-	148.0	132.8	-	-	331.4
334.6	-	-	-	-	-	165.3	-	-	-	147.2	132.3	-	-	334.6
347.8	-	-	-	-	-	152.1	-	-	-	143.9	129.7	-	-	347.8
351.1	-	-	-	-	-	-	-	-	-	143.0	129.0	-	-	351.1
360.9	-	-	-	-	-	-	-	-	-	140.0	-	-	-	360.9
367.5	-	-	-	-	-	-	-	-	-	137.8	-	-	-	367.5
370.7	-	-	-	-	-	-	-	-	-	-	-	-	-	370.7
374.0	-	-	-	-	-	-	-	-	-	-	-	-	-	374.0
383.9	-	-	-	-	-	-	-	-	-	-	-	-	-	383.9



Operation

SSL/LSL S1+LF

551,200 lb + 176,400 lb 49.2-108.3 ft 49.2-78.7 ft 31.5 ft 32.2 ft/s 360° ASME B30.5																			
216.5 ft																			
49.2 ft			68.9 ft				88.6 ft			108.3 ft									
0 lb			0 - 992,100 lb				0 lb			0 - 992,100 lb									
15°			20°		30°		15°		20°		30°		15°		20°		30°		
ft	1,000 lb														ft				
45.9	551.2	551.2	-	-	-	-	-	-	-	-	-	-	-	-	-	-	-	-	45.9
49.2	551.2	551.2	551.2	-	-	-	-	-	-	-	-	-	-	-	-	-	-	-	49.2
52.5	551.2	551.2	551.2	-	526.9	549.0	-	-	-	-	-	-	-	-	-	-	-	-	52.5
55.8	551.2	551.2	547.8	354.9	518.1	532.4	414.5	-	-	-	-	-	-	-	-	-	-	-	55.8
59.1	551.2	551.2	544.5	354.9	509.3	518.1	414.5	-	407.9	414.5	-	-	-	-	-	-	-	-	59.1
65.6	520.3	551.2	526.9	343.9	482.8	489.4	394.6	253.5	399.0	401.2	313.1	-	326.3	330.7	-	-	-	-	65.6
72.2	472.9	551.2	504.9	336.2	451.9	466.3	378.1	246.9	378.1	381.4	303.1	-	314.2	317.5	244.7	-	-	-	72.2
78.7	425.5	551.2	482.8	328.5	421.1	443.1	361.6	240.3	359.4	361.6	293.2	190.7	302.0	304.2	244.7	-	-	-	78.7
85.3	385.8	546.7	464.1	319.7	385.8	422.2	348.3	233.7	342.8	345.0	282.2	186.3	287.7	289.9	234.8	-	-	-	85.3
88.6	366.0	544.5	454.7	315.3	368.2	411.7	341.7	230.4	334.6	336.8	276.7	184.1	280.5	282.7	229.8	147.7	-	-	88.6
91.9	346.1	542.3	445.3	310.9	350.5	401.2	335.1	227.1	326.3	328.5	271.2	181.9	273.4	275.6	224.9	147.7	-	-	91.9
98.4	319.7	521.4	431.0	302.0	324.1	385.8	323.0	221.0	308.6	315.3	261.2	176.4	262.4	264.6	217.2	144.4	-	-	98.4
111.5	269.0	481.7	403.4	286.6	272.3	356.0	300.9	209.4	271.2	291.0	242.5	166.4	241.4	243.6	202.3	136.7	-	-	111.5
124.7	225.4	447.5	378.1	273.4	228.2	329.6	281.1	199.5	232.6	269.0	226.5	158.2	223.2	225.4	189.0	129.0	-	-	124.7
137.8	191.4	418.9	356.4	261.6	194.4	307.9	263.8	191.1	198.8	249.9	213.1	150.6	199.9	210.2	177.5	122.7	-	-	137.8
150.9	162.0	392.4	337.3	251.3	164.2	288.8	249.1	183.0	168.7	233.7	200.6	143.3	169.8	196.2	166.4	116.8	-	-	150.9
164.0	139.3	371.8	322.6	244.0	142.2	272.6	237.4	175.6	145.9	220.5	190.3	137.4	147.0	183.7	156.9	112.0	-	-	164.0
177.2	119.4	352.7	308.6	236.6	122.4	257.9	226.7	169.4	125.7	208.7	180.8	132.3	126.8	172.7	148.4	107.4	-	-	177.2
190.3	102.5	335.1	295.4	229.3	104.9	244.7	217.2	164.2	108.0	198.4	172.0	127.9	109.3	163.1	141.1	103.2	-	-	190.3
203.4	88.6	321.9	285.1	224.9	90.8	234.4	209.1	159.8	93.8	188.9	165.3	123.5	94.9	155.8	135.2	99.6	-	-	203.4
216.5	75.9	309.4	276.3	-	78.0	224.9	201.7	156.0	80.8	180.0	159.1	119.8	81.9	148.8	129.7	96.3	-	-	216.5
223.1	70.3	303.5	272.6	-	72.3	220.5	198.4	154.3	75.0	176.0	156.2	118.3	76.0	145.5	127.1	94.8	-	-	223.1
229.7	64.6	297.6	269.0	-	66.6	216.1	195.1	-	69.2	172.0	153.2	116.8	70.1	142.2	124.6	93.3	-	-	229.7
242.8	55.1	288.8	-	-	57.2	208.7	189.2	-	59.5	165.3	148.1	114.6	60.4	136.3	120.2	90.9	-	-	242.8
249.3	-	-	-	-	52.5	205.0	186.3	-	54.7	162.0	145.5	-	55.6	133.4	117.9	89.7	-	-	249.3
255.9	-	-	-	-	48.4	202.3	-	-	50.7	159.5	143.7	-	51.4	130.8	116.1	88.8	-	-	255.9
262.5	-	-	-	-	44.3	199.5	-	-	46.7	156.9	141.8	-	47.3	128.2	114.3	88.0	-	-	262.5
269.0	-	-	-	-	-	-	-	-	42.8	154.3	140.0	-	43.2	125.7	112.4	-	-	-	269.0
275.6	-	-	-	-	-	-	-	-	39.0	152.1	-	-	39.8	123.8	111.2	-	-	-	275.6
282.2	-	-	-	-	-	-	-	-	-	-	-	-	36.3	122.0	109.9	-	-	-	282.2
288.7	-	-	-	-	-	-	-	-	-	-	-	-	32.8	120.2	108.7	-	-	-	288.7
295.3	-	-	-	-	-	-	-	-	-	-	-	-	29.8	119.0	-	-	-	-	295.3

	0 lb	176,400 lb	352,800 lb	529,200 lb	705,600 lb	882,000 lb	992,100 lb
--	------	------------	------------	------------	------------	------------	------------

Operation

SSL/LSL S1+LF

551,200 lb + 176,400 lb 49.2-108.3 ft 49.2-78.7 ft 31.5 ft 32.2 ft/s 360° ASME B30.5																	
236.2 ft																	
49.2 ft			68.9 ft				88.6 ft			108.3 ft							
0 lb			0 - 992,100 lb				0 lb			0 - 992,100 lb				0 lb			
15°			20°		30°		15°		20°		30°		15°		30°		
ft	1,000 lb															ft	
45.9	551.2	551.2	-	-	-	-	-	-	-	-	-	-	-	-	-	-	45.9
49.2	551.2	551.2	551.2	-	-	-	-	-	-	-	-	-	-	-	-	-	49.2
52.5	551.2	551.2	551.2	-	518.1	540.1	-	-	-	-	-	-	-	-	-	-	52.5
59.1	551.2	551.2	546.7	354.9	518.1	524.7	410.1	-	403.4	418.9	-	-	-	-	-	-	59.1
65.6	500.4	551.2	533.5	346.1	489.4	496.0	399.0	-	403.4	407.9	317.5	-	321.9	332.9	-	-	65.6
68.9	477.9	551.2	523.0	342.3	468.5	484.5	391.3	251.3	393.5	397.9	312.5	-	318.0	326.8	-	-	68.9
72.2	455.3	551.2	512.6	338.4	447.5	472.9	383.6	248.4	383.6	388.0	307.5	-	314.2	320.8	-	-	72.2
75.5	432.7	551.2	502.1	334.6	426.6	461.3	375.9	245.4	373.7	378.1	302.6	-	310.3	314.7	246.9	-	75.5
78.7	410.1	551.2	491.6	330.7	405.7	449.7	368.2	242.5	363.8	368.2	297.6	188.5	306.4	308.6	246.9	-	78.7
85.3	373.7	551.2	474.0	323.0	372.6	431.0	354.9	235.9	348.3	352.7	286.6	185.7	292.1	295.4	238.1	-	85.3
91.9	337.3	551.2	456.4	315.3	339.5	412.3	341.7	229.3	332.9	337.3	275.6	183.0	277.8	282.2	229.3	147.7	91.9
98.4	310.9	534.6	442.0	307.5	309.7	395.7	329.6	223.8	308.6	323.0	265.7	178.0	266.8	270.1	221.0	145.0	98.4
111.5	260.1	499.3	414.5	292.1	260.1	366.0	307.5	212.7	260.1	297.6	246.9	168.7	245.8	249.1	205.6	138.3	111.5
124.7	217.2	464.1	389.1	278.9	221.0	340.6	288.8	202.8	221.0	276.7	231.5	160.4	222.7	231.5	192.4	131.2	124.7
137.8	183.4	434.3	367.4	268.2	187.0	318.2	272.6	194.4	191.1	258.7	218.6	153.2	194.0	215.7	181.1	124.9	137.8
150.9	153.2	407.9	348.3	257.9	157.6	297.6	257.9	186.3	160.9	242.5	206.1	146.6	163.1	201.7	170.9	119.0	150.9
164.0	131.2	385.8	333.6	249.1	134.8	281.5	244.7	179.7	138.2	227.8	195.1	140.7	140.4	189.2	161.3	113.9	164.0
177.2	111.6	366.0	319.7	241.8	114.7	267.5	233.7	173.4	118.0	215.3	185.6	135.2	120.0	178.2	152.9	109.3	177.2
190.3	94.4	348.3	306.4	235.9	97.2	255.7	224.9	167.6	100.5	205.0	177.5	130.1	102.1	168.7	145.5	105.2	190.3
203.4	80.4	333.6	294.7	230.0	83.1	244.0	216.1	163.1	86.3	195.5	170.1	126.4	87.7	161.3	139.6	101.6	203.4
216.5	67.8	320.4	284.4	224.9	70.3	233.0	208.0	159.1	73.3	186.7	163.5	122.7	74.6	154.0	134.1	98.4	216.5
223.1	62.1	314.5	280.0	222.7	64.4	227.8	204.3	157.3	67.4	182.6	160.6	120.9	68.7	150.3	131.5	96.9	223.1
229.7	56.4	308.6	275.6	-	58.6	222.7	200.6	155.4	61.5	178.6	157.6	119.0	62.8	146.6	129.0	95.5	229.7
236.2	51.7	304.2	272.6	-	53.9	219.0	197.7	154.3	56.7	175.3	155.1	117.6	57.9	143.7	126.4	94.1	236.2
242.8	47.0	299.8	269.7	-	49.1	215.3	194.7	-	51.8	172.0	152.5	116.1	53.0	140.7	123.8	92.8	242.8
249.3	42.3	295.4	266.8	-	44.3	211.6	191.8	-	47.0	168.7	149.9	114.6	48.1	137.8	121.3	91.5	249.3
255.9	38.1	284.4	-	-	40.3	208.7	189.6	-	42.8	165.7	147.7	114.6	43.9	135.2	119.4	90.5	255.9
262.5	-	-	-	-	36.4	205.8	187.4	-	38.7	162.8	145.5	-	39.7	132.6	117.6	89.6	262.5
269.0	-	-	-	-	32.4	202.8	-	-	34.6	159.8	143.3	-	35.5	130.1	115.7	88.6	269.0
275.6	-	-	-	-	28.7	200.6	-	-	31.2	157.6	141.6	-	32.0	127.9	114.3	87.7	275.6
282.2	-	-	-	-	-	-	-	-	27.9	155.4	140.0	-	28.6	125.7	112.8	-	282.2
295.3	-	-	-	-	-	-	-	-	22.1	151.0	-	-	22.1	122.0	110.1	-	295.3
301.8	-	-	-	-	-	-	-	-	-	-	-	-	19.1	120.5	108.9	-	301.8
308.4	-	-	-	-	-	-	-	-	-	-	-	-	16.1	119.0	-	-	308.4
315.0	-	-	-	-	-	-	-	-	-	-	-	-	13.4	117.9	-	-	315.0

	0 lb	176,400 lb	352,800 lb	529,200 lb	705,600 lb	882,000 lb	992,100 lb
--	------	------------	------------	------------	------------	------------	------------

Operation

SSL/LSL S1+LF

551,200 lb + 176,400 lb 49.2-108.3 ft 49.2-78.7 ft 31.5 ft 32.2 ft/s 360° ASME B30.5																			
255.9 ft																			
49.2 ft				68.9 ft				88.6 ft				108.3 ft							
0 lb				0 - 992,100 lb				0 lb				0 - 992,100 lb							
15°			20°			30°			15°			20°			30°				
ft	1,000 lb																		ft
49.2	551.2	551.2	-	-	-	-	-	-	-	-	-	-	-	-	-	-	-	-	49.2
52.5	551.2	551.2	551.2	-	-	-	-	-	-	-	-	-	-	-	-	-	-	-	52.5
55.8	545.6	551.2	551.2	-	524.7	546.7	-	-	-	-	-	-	-	-	-	-	-	-	55.8
59.1	540.1	551.2	551.2	352.7	524.7	533.5	414.5	-	-	-	-	-	-	-	-	-	-	-	59.1
62.3	511.5	551.2	545.6	350.5	501.6	520.3	411.2	-	407.9	414.5	-	-	-	-	-	-	-	-	62.3
65.6	482.8	551.2	540.1	348.3	478.4	507.1	407.9	-	407.9	414.5	-	-	-	-	-	-	-	-	65.6
68.9	460.8	551.2	530.8	344.5	456.9	495.5	399.6	-	399.0	405.1	315.3	-	317.5	328.5	-	-	-	-	68.9
72.2	438.7	551.2	521.4	340.6	435.4	483.9	391.3	249.1	390.2	395.7	310.9	-	315.3	323.3	-	-	-	-	72.2
75.5	416.7	551.2	512.0	336.8	413.9	472.3	383.1	248.0	381.4	386.4	306.4	-	313.1	318.2	246.9	-	-	-	75.5
78.7	394.6	551.2	502.7	332.9	392.4	460.8	374.8	246.9	372.6	377.0	302.0	-	310.9	313.1	246.9	-	-	-	78.7
82.0	378.6	550.6	494.4	329.6	376.4	451.4	368.2	243.6	361.6	368.7	296.5	190.7	304.2	306.4	243.1	-	-	-	82.0
85.3	362.7	550.1	486.1	326.3	360.5	442.0	361.6	240.3	350.5	360.5	291.0	188.9	297.6	299.8	239.2	-	-	-	85.3
91.9	330.7	549.0	469.6	319.7	328.5	423.3	348.3	233.7	328.5	343.9	280.0	185.2	284.4	286.6	231.5	147.7	-	-	91.9
98.4	305.3	541.2	454.2	312.0	300.9	407.9	337.3	228.2	304.2	330.7	271.2	180.8	273.4	275.6	224.3	145.5	-	-	98.4
111.5	254.6	515.9	426.6	297.6	253.5	378.1	316.4	217.2	255.7	306.4	253.5	172.0	248.0	254.6	210.0	140.0	-	-	111.5
124.7	210.5	481.7	402.3	285.5	215.0	352.7	297.6	207.2	216.1	285.5	238.1	163.7	214.4	237.0	196.8	133.4	-	-	124.7
137.8	177.1	451.2	380.7	274.8	181.1	331.4	281.5	198.8	185.6	267.5	225.2	156.5	182.6	222.3	185.6	127.1	-	-	137.8
150.9	147.7	423.3	361.6	264.6	151.0	310.9	266.8	190.7	155.4	251.3	212.7	149.9	157.6	208.3	175.3	121.3	-	-	150.9
164.0	124.9	401.2	343.9	255.7	128.2	293.2	253.5	184.1	132.6	236.6	201.7	144.0	134.1	195.8	166.4	116.1	-	-	164.0
177.2	105.0	381.4	328.5	247.7	108.2	277.8	241.8	177.8	112.3	223.8	192.2	138.5	113.6	184.8	158.0	111.6	-	-	177.2
190.3	88.0	363.8	315.3	240.3	90.8	264.6	231.5	172.0	94.4	212.7	184.1	133.4	96.1	175.3	149.9	107.8	-	-	190.3
203.4	73.9	349.1	305.0	234.4	76.6	252.8	223.4	166.8	80.0	203.2	176.7	129.7	81.6	167.2	144.0	104.1	-	-	203.4
216.5	61.1	335.1	294.7	229.3	63.6	241.8	215.3	162.4	66.9	194.4	169.8	126.0	68.3	159.5	138.5	100.8	-	-	216.5
229.7	49.8	321.9	284.4	224.9	52.0	231.5	207.2	158.7	55.1	186.3	163.1	122.4	56.4	152.1	133.4	97.9	-	-	229.7
236.2	45.0	315.3	280.7	222.7	47.3	227.4	204.3	157.3	50.2	182.6	160.6	120.9	51.5	149.2	130.8	96.5	-	-	236.2
242.8	40.3	308.6	277.0	-	42.5	223.4	201.4	155.8	45.3	178.9	158.0	119.4	46.6	146.2	128.2	95.1	-	-	242.8
255.9	31.6	287.3	271.2	-	33.7	216.1	195.8	153.2	36.3	172.3	153.2	116.8	37.5	140.7	123.8	92.7	-	-	255.9
262.5	27.7	272.6	269.0	-	29.6	212.7	193.3	-	32.3	169.4	151.0	115.7	33.3	138.2	122.0	91.6	-	-	262.5
269.0	23.8	260.1	-	-	25.6	209.4	190.7	-	28.2	166.4	148.8	114.6	29.1	135.6	120.2	90.6	-	-	269.0
275.6	20.3	251.3	-	-	22.1	206.9	188.5	-	24.7	163.9	146.6	-	25.6	133.4	118.3	89.7	-	-	275.6
282.2	-	-	-	-	18.7	204.3	186.3	-	21.2	161.3	144.4	-	22.0	131.2	116.5	88.8	-	-	282.2
288.7	-	-	-	-	15.2	201.7	-	-	17.6	158.7	142.2	-	18.5	129.0	114.6	88.0	-	-	288.7
295.3	-	-	-	-	12.3	199.5	-	-	14.6	156.5	141.1	-	15.4	126.8	113.0	-	-	-	295.3
301.8	-	-	-	-	-	-	-	-	11.5	154.3	140.0	-	12.3	124.6	111.3	-	-	-	301.8
308.4	-	-	-	-	-	-	-	-	-	152.1	-	-	-	123.5	110.2	-	-	-	308.4
315.0	-	-	-	-	-	-	-	-	-	151.0	-	-	-	121.6	109.5	-	-	-	315.0
321.5	-	-	-	-	-	-	-	-	-	-	-	-	-	119.8	108.7	-	-	-	321.5
328.1	-	-	-	-	-	-	-	-	-	-	-	-	-	117.9	-	-	-	-	328.1

	0 lb		176,400 lb		352,800 lb		529,200 lb		705,600 lb		882,000 lb		992,100 lb
--	------	--	------------	--	------------	--	------------	--	------------	--	------------	--	------------

Operation

SSL/LSL S1+LF

551,200 lb + 176,400 lb 49.2-108.3 ft 49.2-78.7 ft 31.5 ft 32.2 ft/s 360° ASME B30.5																
275.6 ft																
49.2 ft			68.9 ft				88.6 ft			108.3 ft						
0 lb			0 - 992,100 lb				0 lb			0 - 992,100 lb						
15°			20°		30°		15°		20°		30°		15°		30°	
ft	1,000 lb															ft
49.2	551.2	551.2	-	-	-	-	-	-	-	-	-	-	-	-	-	49.2
52.5	551.2	551.2	551.2	-	-	-	-	-	-	-	-	-	-	-	-	52.5
55.8	535.7	551.2	551.2	-	515.9	537.9	-	-	-	-	-	-	-	-	-	55.8
59.1	520.3	551.2	551.2	-	515.9	537.9	-	-	-	-	-	-	-	-	-	59.1
62.3	492.7	551.2	547.8	352.7	488.3	524.7	410.1	-	401.2	416.7	-	-	-	-	-	62.3
65.6	465.2	551.2	544.5	350.5	460.8	511.5	410.1	-	401.2	416.7	-	-	-	-	-	65.6
68.9	443.7	551.2	536.3	346.7	440.4	501.0	402.3	-	395.2	407.9	317.5	-	319.7	332.9	-	68.9
72.2	422.2	551.2	528.0	342.8	420.0	490.5	394.6	251.3	389.1	399.0	313.1	-	317.5	327.8	-	72.2
78.7	379.2	551.2	511.5	335.1	379.2	469.6	379.2	246.9	377.0	381.4	304.2	-	313.1	317.5	246.9	78.7
82.0	363.8	551.2	503.2	331.8	363.2	460.2	373.1	244.2	361.6	373.7	299.3	189.6	307.0	310.9	244.2	82.0
85.3	348.3	551.2	494.9	328.5	347.2	450.8	367.1	241.4	346.1	366.0	294.3	188.5	300.9	304.2	241.4	85.3
91.9	317.5	551.2	478.4	321.9	315.3	432.1	354.9	235.9	315.3	350.5	284.4	186.3	288.8	291.0	235.9	91.9
95.1	303.1	550.1	470.7	318.6	303.1	424.4	349.4	233.1	303.7	343.9	279.4	184.1	283.3	285.5	231.8	95.1
98.4	288.8	549.0	463.0	315.3	291.0	416.7	343.9	230.4	292.1	337.3	274.5	181.9	277.8	280.0	227.6	98.4
111.5	241.4	529.1	435.4	302.0	242.5	388.0	323.0	219.9	245.8	313.1	256.8	173.1	246.9	260.1	212.7	111.5
124.7	203.4	494.9	412.3	289.9	203.4	362.7	304.2	210.5	208.3	292.1	242.5	165.3	207.8	242.5	200.1	124.7
137.8	169.0	464.4	391.0	279.3	173.4	340.2	288.1	202.1	178.6	274.1	230.0	158.7	176.0	227.1	188.9	137.8
150.9	138.9	436.5	370.4	269.0	143.3	319.7	273.4	194.0	147.7	257.9	218.3	152.1	151.0	213.8	178.6	150.9
164.0	117.0	413.0	354.2	260.1	121.0	302.0	260.1	187.4	124.9	243.2	207.2	146.2	127.5	201.4	169.8	164.0
177.2	97.3	393.2	339.5	252.1	100.9	286.6	248.4	181.1	104.6	230.4	197.3	140.7	106.8	190.3	161.7	177.2
190.3	79.8	377.0	326.3	244.7	83.1	273.4	238.1	175.3	86.9	219.4	188.5	135.6	88.8	180.8	154.3	190.3
203.4	65.8	362.3	314.5	238.8	68.9	261.6	229.3	170.1	72.3	209.8	181.1	131.9	74.3	172.0	147.7	203.4
216.5	53.1	348.3	303.5	233.7	55.9	250.6	221.2	165.7	59.2	200.6	174.2	128.2	61.0	164.2	141.8	216.5
229.7	41.4	335.1	293.2	229.3	44.1	240.3	213.8	162.0	47.4	191.8	167.6	124.6	48.9	157.6	136.7	229.7
242.8	32.0	320.4	284.4	224.9	34.4	231.5	206.5	158.4	37.6	184.5	162.4	121.6	38.9	151.0	131.5	242.8
249.3	27.3	313.1	280.0	222.7	29.5	227.1	202.8	156.5	32.6	180.8	159.8	120.2	34.0	147.7	129.0	249.3
255.9	23.4	299.1	276.3	-	25.5	223.4	200.3	155.4	28.5	177.5	157.3	118.7	29.8	145.1	127.1	255.9
269.0	15.4	271.2	269.0	-	17.4	216.1	195.1	153.2	20.3	170.9	152.1	115.7	21.4	140.0	123.5	269.0
275.6	11.7	255.7	255.7	-	13.7	212.7	192.9	-	16.6	168.1	149.9	115.2	17.7	137.2	121.6	275.6
282.2	-	240.3	240.3	-	-	210.0	190.7	-	13.0	165.3	147.7	114.6	14.1	134.5	119.8	282.2
288.7	-	229.3	-	-	-	207.2	188.5	-	-	163.1	146.6	113.5	-	132.3	117.9	288.7
295.3	-	-	-	-	-	204.7	186.3	-	-	160.9	144.8	-	-	130.4	116.5	295.3
301.8	-	-	-	-	-	202.1	-	-	-	158.7	142.9	-	-	128.6	115.0	301.8
308.4	-	-	-	-	-	199.5	-	-	-	156.5	141.1	-	-	126.8	113.5	308.4
315.0	-	-	-	-	-	-	-	-	-	154.7	140.0	-	-	124.9	112.3	315.0
321.5	-	-	-	-	-	-	-	-	-	152.9	-	-	-	123.1	111.0	321.5
328.1	-	-	-	-	-	-	-	-	-	151.0	-	-	-	121.3	109.8	328.1
334.6	-	-	-	-	-	-	-	-	-	-	-	-	-	120.2	-	334.6
341.2	-	-	-	-	-	-	-	-	-	-	-	-	-	119.0	-	341.2

	0 lb	176,400 lb	352,800 lb	529,200 lb	705,600 lb	882,000 lb	992,100 lb
--	------	------------	------------	------------	------------	------------	------------

Operation

SSL/LSL S1+LF

551,200 lb + 176,400 lb 49.2-108.3 ft 49.2-78.7 ft 31.5 ft 32.2 ft/s 360° ASME B30.5																		
295.3 ft																		
49.2 ft			68.9 ft				88.6 ft			108.3 ft								
0 lb			0 - 992,100 lb				0 lb			0 - 992,100 lb				0 lb				
15°			20°		30°		15°		20°		30°		15°		20°		30°	
1,000 lb																		
ft	ft	ft	ft	ft	ft	ft	ft	ft	ft	ft	ft	ft	ft	ft	ft	ft	ft	
52.5	551.2	551.2	-	-	-	-	-	-	-	-	-	-	-	-	-	-	52.5	
55.8	526.9	551.2	551.2	-	-	-	-	-	-	-	-	-	-	-	-	-	55.8	
59.1	502.7	551.2	551.2	-	496.0	529.1	-	-	-	-	-	-	-	-	-	-	59.1	
62.3	476.2	551.2	550.1	350.5	470.7	523.6	412.3	-	-	-	-	-	-	-	-	-	62.3	
65.6	449.7	551.2	549.0	350.5	445.3	518.1	412.3	-	396.8	412.3	-	-	-	-	-	-	65.6	
72.2	407.9	551.2	533.5	343.9	405.7	496.0	397.9	-	380.3	399.0	313.1	-	315.3	326.3	-	-	72.2	
75.5	386.9	551.2	525.8	340.6	385.8	485.0	390.8	249.1	372.0	392.4	309.7	-	315.3	323.0	-	-	75.5	
78.7	366.0	551.2	518.1	337.3	366.0	474.0	383.6	249.1	363.8	385.8	306.4	-	315.3	319.7	244.7	-	78.7	
85.3	335.1	551.2	501.6	330.7	335.1	457.5	371.5	242.5	334.0	370.4	296.5	189.6	303.1	307.5	240.3	-	85.3	
91.9	304.2	551.2	485.0	324.1	304.2	440.9	359.4	235.9	304.2	354.9	286.6	187.4	291.0	295.4	235.9	-	91.9	
95.1	292.1	550.1	477.9	321.3	292.7	432.7	353.8	233.7	292.7	348.9	282.2	185.2	282.7	289.9	232.6	146.6	95.1	
98.4	280.0	549.0	470.7	318.6	281.1	424.4	348.3	231.5	281.1	342.8	277.8	183.0	274.5	284.4	229.3	146.2	98.4	
111.5	236.4	535.7	444.2	306.4	235.3	394.6	327.4	222.1	238.1	319.7	261.2	174.7	239.2	264.6	216.1	142.2	111.5	
124.7	197.3	508.2	421.1	294.3	197.9	370.4	309.7	212.7	199.0	298.7	246.9	167.0	201.7	246.9	203.4	135.6	124.7	
137.8	162.8	476.9	399.8	283.7	167.9	349.1	294.7	204.7	167.2	280.7	234.4	160.2	170.5	231.5	192.2	129.7	137.8	
150.9	133.4	447.5	379.2	273.4	137.8	328.5	280.0	197.3	142.2	264.6	222.7	154.3	145.5	218.3	181.9	124.6	150.9	
164.0	110.9	424.0	361.6	264.6	114.9	310.9	266.8	190.0	119.1	249.9	211.6	148.4	122.0	206.5	173.1	119.4	164.0	
177.2	90.8	403.4	346.1	256.5	94.4	294.7	255.0	183.7	98.5	236.6	201.7	143.3	101.1	195.5	165.0	115.0	177.2	
190.3	73.2	385.8	332.9	249.1	76.5	280.0	244.7	178.6	80.5	224.9	192.9	138.9	82.9	185.2	157.6	111.3	190.3	
203.4	59.1	372.6	322.6	243.2	62.2	268.2	234.4	173.4	66.1	215.3	185.6	134.5	68.2	176.4	151.0	107.7	203.4	
216.5	46.3	359.4	312.3	237.4	49.2	257.2	226.0	168.7	52.9	206.1	178.6	130.4	54.8	168.7	145.1	104.3	216.5	
229.7	34.8	346.1	302.0	231.5	37.5	246.9	219.4	164.2	41.0	197.3	172.0	126.8	42.8	162.0	140.0	101.2	229.7	
242.8	25.3	324.1	293.2	227.1	27.8	238.1	212.0	160.6	31.2	190.0	166.1	123.8	32.8	155.4	134.8	98.5	242.8	
255.9	16.4	302.0	284.4	224.9	18.7	229.3	205.6	157.6	22.0	183.0	160.9	120.9	23.5	149.5	130.1	96.0	255.9	
262.5	12.3	291.0	280.0	222.7	14.6	224.9	202.8	156.5	17.9	179.7	158.7	119.4	19.3	147.0	127.9	94.9	262.5	
269.0	-	277.8	273.4	-	-	222.7	199.5	155.4	13.7	176.4	156.5	117.9	15.0	144.4	125.7	93.7	269.0	
275.6	-	263.8	261.6	-	-	219.4	197.3	154.3	-	173.4	154.3	116.8	11.2	141.1	124.6	92.7	275.6	
282.2	-	249.9	249.9	-	-	216.1	195.1	153.2	-	170.5	152.1	115.7	-	138.9	122.4	91.7	282.2	
295.3	-	223.0	224.9	-	-	210.2	191.1	-	-	165.3	148.1	114.1	-	134.5	118.7	89.9	295.3	
301.8	-	210.9	-	-	-	207.6	189.2	-	-	163.1	146.2	113.5	-	132.3	117.2	89.1	301.8	
308.4	-	203.9	-	-	-	205.0	187.4	-	-	160.9	144.4	-	-	130.1	115.7	88.4	308.4	
315.0	-	-	-	-	-	198.8	185.2	-	-	158.7	142.9	-	-	128.2	114.3	87.7	315.0	
321.5	-	-	-	-	-	192.5	-	-	-	156.5	141.5	-	-	126.4	112.8	87.1	321.5	
328.1	-	-	-	-	-	186.3	-	-	-	154.3	140.0	-	-	124.6	111.3	-	328.1	
334.6	-	-	-	-	-	-	-	-	-	152.7	-	-	-	123.1	110.5	-	334.6	
341.2	-	-	-	-	-	-	-	-	-	151.0	-	-	-	121.6	109.7	-	341.2	
347.8	-	-	-	-	-	-	-	-	-	-	-	-	-	120.2	108.9	-	347.8	
354.3	-	-	-	-	-	-	-	-	-	-	-	-	-	119.0	108.0	-	354.3	
360.9	-	-	-	-	-	-	-	-	-	-	-	-	-	117.9	-	-	360.9	
367.5	-	-	-	-	-	-	-	-	-	-	-	-	-	116.8	-	-	367.5	

	0 lb	176,400 lb	352,800 lb	529,200 lb	705,600 lb	882,000 lb	992,100 lb
--	------	------------	------------	------------	------------	------------	------------

Operation

SSL/LSL S1+LF

551,200 lb + 176,400 lb 49.2-108.3 ft 49.2-78.7 ft 31.5 ft 32.2 ft/s 360° ASME B30.5

315.0 ft																	
49.2 ft			68.9 ft				88.6 ft			108.3 ft							
0 lb			0 - 992,100 lb				0 lb			0 - 992,100 lb							
15°			20°		30°		15°		20°		30°		15°		30°		
1,000 lb																	
ft	ft	ft	ft	ft	ft	ft	ft	ft	ft	ft	ft	ft	ft	ft	ft	ft	
52.5	544.5	551.2	-	-	-	-	-	-	-	-	-	-	-	-	-	52.5	
55.8	513.7	551.2	551.2	-	-	-	-	-	-	-	-	-	-	-	-	55.8	
59.1	482.8	551.2	551.2	-	478.4	531.3	-	-	-	-	-	-	-	-	-	59.1	
65.6	432.1	551.2	551.2	346.1	429.9	522.5	407.9	-	392.4	414.5	-	-	-	-	-	65.6	
72.2	392.4	551.2	537.9	341.7	390.2	501.6	397.9	-	371.5	401.2	308.6	-	306.4	321.9	-	72.2	
75.5	372.6	551.2	531.3	339.5	370.4	491.1	393.0	249.1	361.0	394.6	308.6	-	306.4	321.9	-	75.5	
78.7	352.7	551.2	524.7	337.3	350.5	480.6	388.0	249.1	350.5	388.0	308.6	-	306.4	321.9	-	78.7	
82.0	337.3	551.2	516.4	334.6	336.2	471.8	382.0	246.4	336.2	380.8	303.7	-	303.1	315.8	246.9	82.0	
85.3	321.9	551.2	508.2	331.8	321.9	463.0	375.9	243.6	321.9	373.7	298.7	-	299.8	309.7	244.0	85.3	
88.6	306.4	551.2	499.9	329.0	307.5	454.2	369.8	240.9	307.5	366.5	293.8	188.5	296.5	303.7	241.0	88.6	
91.9	291.0	551.2	491.6	326.3	293.2	445.3	363.8	238.1	293.2	359.4	288.8	188.5	293.2	297.6	238.1	91.9	
98.4	267.9	549.0	477.3	320.8	270.1	431.0	352.7	233.7	270.1	347.2	281.1	184.1	270.1	287.7	231.5	145.5	98.4
111.5	222.1	540.1	450.8	309.7	226.0	403.4	332.9	224.3	229.3	324.1	265.7	175.8	229.3	267.9	218.3	142.2	111.5
124.7	184.6	518.1	427.7	298.7	190.1	378.1	315.3	215.0	192.4	304.2	250.2	168.7	194.0	250.2	206.1	136.1	124.7
137.8	155.1	488.7	407.1	288.1	160.2	356.4	299.1	206.9	160.2	287.3	237.4	162.0	163.5	235.9	195.5	130.8	137.8
150.9	125.7	460.8	388.0	277.8	130.1	337.3	284.4	199.5	134.5	271.2	227.1	155.4	137.8	222.7	185.2	125.7	150.9
164.0	103.0	436.5	370.4	269.0	107.1	319.7	272.6	192.9	111.7	256.5	216.1	150.3	114.7	210.9	176.4	121.3	164.0
177.2	82.9	415.9	354.2	260.9	86.7	302.8	260.9	186.7	91.2	243.2	206.1	145.5	94.0	200.3	168.3	116.8	177.2
190.3	65.3	396.8	339.5	253.5	68.8	286.6	249.1	180.8	73.0	231.5	197.3	141.1	75.6	190.7	160.9	112.4	190.3
203.4	51.1	382.1	327.8	247.7	54.5	274.8	240.3	176.4	58.4	221.2	190.0	136.7	60.8	181.1	154.3	109.2	203.4
216.5	38.3	364.5	318.2	241.8	41.5	263.8	231.5	172.0	45.2	211.6	183.0	132.6	47.3	172.7	148.1	106.0	216.5
229.7	26.7	343.9	310.9	235.9	29.8	253.5	222.7	167.6	33.3	202.8	176.4	129.0	35.3	165.3	142.2	103.0	229.7
242.8	17.1	318.9	302.0	231.5	19.9	244.7	216.8	163.9	23.3	195.5	170.5	126.0	25.1	159.5	137.8	100.2	242.8
249.3	12.3	306.4	297.6	229.3	15.0	240.3	213.8	162.0	18.3	191.8	167.6	124.6	20.1	156.5	135.6	98.8	249.3
255.9	-	296.2	290.3	227.8	-	236.6	210.9	159.8	13.9	188.5	164.8	123.1	15.8	153.8	133.4	97.7	255.9
262.5	-	285.9	282.9	226.3	-	233.0	208.0	158.7	-	185.2	162.0	121.6	11.5	151.0	131.2	96.6	262.5
269.0	-	275.6	275.6	224.9	-	229.3	205.0	157.6	-	181.9	159.8	120.2	-	147.7	129.0	95.5	269.0
275.6	-	264.6	264.6	222.7	-	225.6	202.5	156.2	-	178.9	157.6	119.0	-	145.1	127.1	94.4	275.6
282.2	-	253.5	253.5	-	-	221.9	199.9	154.7	-	176.0	155.4	117.9	-	142.6	125.3	93.3	282.2
295.3	-	230.0	230.4	-	-	215.3	195.1	152.1	-	170.5	151.4	115.7	-	137.8	121.6	91.3	295.3
308.4	-	205.0	206.1	-	-	209.4	190.7	-	-	165.3	147.7	113.5	-	133.4	117.9	89.7	308.4
315.0	-	193.3	-	-	-	201.0	188.9	-	-	163.1	146.1	113.5	-	131.5	116.5	89.0	315.0
321.5	-	184.8	-	-	-	192.5	187.0	-	-	160.9	144.4	-	-	129.7	115.0	88.3	321.5
328.1	-	178.6	-	-	-	184.1	185.2	-	-	158.7	142.2	-	-	127.9	113.5	87.5	328.1
334.6	-	-	-	-	-	174.2	-	-	-	156.9	141.1	-	-	126.4	112.4	-	334.6
341.2	-	-	-	-	-	168.7	-	-	-	155.1	140.0	-	-	124.9	111.3	-	341.2
347.8	-	-	-	-	-	-	-	-	-	153.2	-	-	-	123.5	110.2	-	347.8
354.3	-	-	-	-	-	-	-	-	-	152.1	-	-	-	122.0	109.8	-	354.3
360.9	-	-	-	-	-	-	-	-	-	-	-	-	-	120.5	108.9	-	360.9
367.5	-	-	-	-	-	-	-	-	-	-	-	-	-	119.0	108.0	-	367.5
374.0	-	-	-	-	-	-	-	-	-	-	-	-	-	117.9	-	-	374.0
380.6	-	-	-	-	-	-	-	-	-	-	-	-	-	116.8	-	-	380.6

	0 lb	176,400 lb	352,800 lb	529,200 lb	705,600 lb	882,000 lb	992,100 lb
--	------	------------	------------	------------	------------	------------	------------

Operation

SSL/LSL+LF SSL/LSL S1+LF

551,200 lb + 176,400 lb 49.2-108.3 ft 49.2-78.7 ft 31.5 ft 32.2 ft/s 360° ASME B30.5

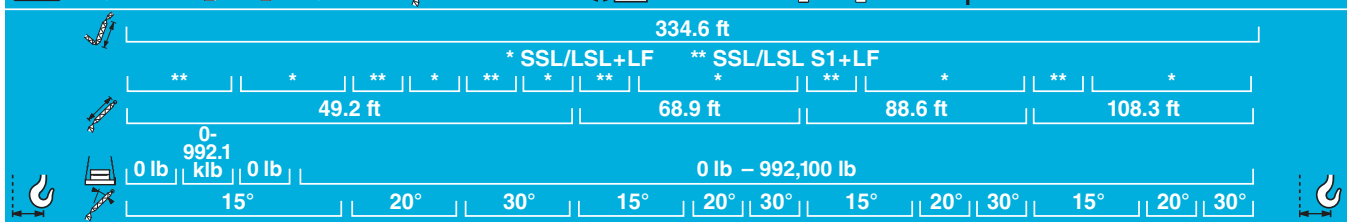

ft	1,000 lb														ft						
55.8	498.2	551.2	493.8	551.2	-	-	-	-	-	-	-	-	-	-	-	-	-	-	55.8		
59.1	469.6	551.2	467.4	551.2	551.2	549.0	-	-	-	-	-	-	-	-	-	-	-	-	59.1		
62.3	445.3	551.2	442.0	551.2	551.2	544.5	-	-	518.1	500.4	-	-	-	-	-	-	-	-	62.3		
65.6	421.1	551.2	416.7	551.2	551.2	540.1	377.0	339.5	518.1	500.4	388.0	-	-	-	-	-	-	-	65.6		
68.9	401.8	551.2	397.4	551.2	551.2	532.4	374.8	337.3	515.9	491.6	385.3	-	403.4	385.8	-	-	-	-	68.9		
72.2	382.5	551.2	378.1	551.2	551.2	524.7	372.6	335.1	513.7	482.8	382.5	-	403.4	380.7	-	-	-	-	72.2		
75.5	363.2	551.2	358.8	551.2	551.2	517.0	370.4	332.9	511.5	474.0	379.7	-	403.4	375.5	295.4	-	321.9	304.2	75.5		
78.7	343.9	551.2	339.5	551.2	551.2	509.3	368.2	330.7	509.3	465.2	377.0	242.5	403.4	370.4	295.4	-	321.9	304.2	78.7		
85.3	315.3	551.2	310.9	551.2	544.5	494.9	363.8	326.3	494.9	449.7	366.0	238.1	395.7	358.3	288.8	-	319.7	296.5	233.7	85.3	
88.6	300.9	551.2	296.5	551.2	541.2	487.8	361.6	324.1	487.8	442.0	360.5	235.9	391.9	352.2	285.5	181.9	318.6	297.5	232.6	88.6	
91.9	286.6	551.2	282.2	551.2	537.9	480.6	359.4	321.9	480.6	434.3	354.9	233.7	388.0	346.1	282.2	181.9	317.5	288.8	231.5	91.9	
98.4	263.5	551.2	259.0	551.2	523.6	468.5	353.8	316.4	465.2	420.0	345.0	229.3	374.8	335.1	274.5	179.1	308.6	278.9	224.9	142.2	98.4
111.5	220.5	551.2	215.5	535.7	496.0	444.2	343.9	306.4	436.5	393.5	326.3	220.5	350.5	314.2	259.0	173.1	289.9	261.2	212.2	138.3	111.5
124.7	185.7	543.4	180.2	506.0	470.7	422.2	335.1	296.5	411.2	371.5	309.7	212.2	329.6	295.4	245.8	165.9	272.3	245.8	201.2	131.2	124.7
137.8	155.8	522.5	150.3	478.4	448.3	402.7	325.5	285.9	388.0	352.0	295.4	204.7	311.6	279.3	233.7	158.4	257.2	232.2	190.7	125.3	137.8
150.9	125.7	500.4	120.2	451.9	427.7	383.6	315.3	275.6	366.0	332.9	282.2	197.3	295.4	264.6	220.5	151.0	242.5	220.5	179.7	120.2	150.9
164.0	103.3	479.9	98.0	429.9	408.6	367.4	306.4	266.8	348.3	316.7	270.4	191.4	280.7	251.3	210.2	145.1	229.3	207.2	170.1	115.0	164.0
177.2	83.3	460.0	78.0	410.1	391.7	352.7	296.9	259.4	331.4	301.3	258.7	185.6	266.0	238.8	200.6	140.0	216.8	195.5	161.3	110.3	177.2
190.3	65.7	440.9	60.4	392.4	377.0	339.5	286.6	253.5	315.3	286.6	246.9	179.7	251.3	227.1	191.8	135.6	205.0	185.2	153.2	106.0	190.3
203.4	51.4	407.1	46.3	377.7	363.8	327.8	279.3	246.2	302.0	274.8	238.1	173.8	239.6	216.8	183.7	131.2	195.5	175.6	146.6	102.2	203.4
216.5	38.6	374.8	33.5	360.8	352.0	317.5	271.9	240.3	290.3	263.8	229.3	168.7	228.9	206.9	176.0	126.8	186.3	166.8	140.4	98.7	216.5
229.7	27.1	343.9	22.0	341.7	341.7	308.6	264.6	235.9	280.0	253.5	220.5	164.2	219.4	197.3	168.7	122.4	177.5	158.7	134.5	95.5	229.7
242.8	17.4	318.9	12.1	315.3	319.7	301.6	258.7	232.4	269.7	244.7	213.4	159.8	210.5	189.6	162.8	119.4	170.1	152.6	129.3	92.5	242.8
249.3	12.6	306.4	-	304.2	308.6	297.6	255.7	229.3	264.6	240.3	209.4	157.6	206.1	185.2	159.8	117.9	166.4	148.8	126.8	91.1	249.3
255.9	-	296.2	-	293.2	297.6	289.5	253.5	227.1	260.1	235.9	206.1	156.7	202.1	182.3	157.6	116.5	163.1	146.2	124.6	89.9	255.9
269.0	-	275.6	-	271.2	275.6	273.4	249.1	222.7	251.3	227.1	199.5	153.2	194.0	175.3	152.1	113.5	156.5	140.0	120.2	87.5	269.0
282.2	-	257.9	-	253.5	257.9	254.3	244.7	219.7	242.5	220.5	194.4	150.3	187.4	169.4	147.7	111.3	150.6	134.8	116.5	85.5	282.2
288.7	-	249.1	-	244.7	249.1	244.7	242.5	218.3	238.1	217.2	191.8	148.8	184.1	166.4	145.5	110.2	147.7	132.3	114.6	84.4	288.7
292.0	-	243.8	-	239.2	244.0	239.6	-	217.2	235.9	215.5	190.5	148.3	182.6	165.2	144.4	109.8	146.4	131.2	113.8	84.0	292.0
295.3	-	238.5	-	233.7	238.8	234.4	-	-	233.7	213.8	189.2	147.7	181.1	163.9	143.3	109.3	145.1	130.1	113.0	83.6	295.3
308.4	-	217.2	-	211.6	218.3	213.8	-	-	224.9	207.2	184.1	145.5	175.3	158.7	138.9	107.6	140.0	125.7	109.8	81.8	308.4
311.7	-	211.6	-	206.3	212.7	208.3	-	-	219.9	204.5	183.2	145.5	174.2	157.4	138.9	107.2	139.1	124.7	109.1	81.5	311.7
321.5	-	195.1	-	190.3	196.2	191.8	-	-	205.0	196.2	180.6	-	170.9	153.6	136.0	106.1	136.3	122.0	106.9	80.5	321.5
328.1	-	184.1	-	179.7	185.2	180.8	-	-	195.1	190.7	178.6	-	168.7	151.0	134.5	105.4	134.5	120.2	105.4	79.8	328.1
334.6	-	173.6	-	169.5	-	-	-	-	185.2	180.8	175.8	-	166.4	149.3	133.0	-	132.6	118.3	104.3	79.3	334.6
341.2	-	167.6	-	163.8	-	-	-	-	175.3	170.9	173.1	-	164.2	147.5	131.5	-	130.8	116.5	103.1	78.8	341.2
344.5	-	-	-	160.9	-	-	-	-	170.9	165.9	168.1	-	163.1	146.6	130.8	-	129.9	115.6	102.5	78.5	344.5
347.8	-	-	-	-	-	-	-	-	166.4	160.9	163.1	-	162.0	145.5	130.1	-	129.0	114.6	101.9	78.3	347.8
354.3	-	-	-	-	-	-	-	-	157.6	155.0	-	-	159.8	144.0	129.3	-	127.1	113.2	100.9	-	354.3
360.9	-	-	-	-	-	-	-	-	-	150.1	-	-	155.4	142.6	128.6	-	125.3	111.7	100.0	-	360.9
364.2	-	-	-	-	-	-	-	-	-	147.7	-	-	153.2	141.8	128.2	-	124.4	111.0	99.5	-	364.2
367.5	-	-	-	-	-	-	-	-	-	-	-	-	151.0	141.1	127.9	-	123.5	110.2	99.0	-	367.5
374.0	-	-	-	-	-	-	-	-	-	-	-	-	145.5	138.5	-	-	122.4	109.4	98.3	-	374.0
380.6	-	-	-	-	-	-	-	-	-	-	-	-	141.1	135.8	-	-	121.3	108.6	97.7	-	380.6
383.9	-	-	-	-	-	-	-	-	-	-	-	-	-	134.5	-	-	120.7	108.2	97.3	-	383.9
387.1	-	-	-	-	-	-	-	-	-	-	-	-	-	-	-	-	120.2	107.8	97.0	-	387.1
393.7	-	-	-	-	-	-	-	-	-	-	-	-	-	-	-	-	119.0	107.0	-	-	393.7
400.3	-	-	-	-	-	-	-	-	-	-	-	-	-	-	-	-	-	106.3	-	-	400.3



Operation

SSL/LSL+LF SSL/LSL S1+LF

551,200 lb + 176,400 lb		49.2-108.3 ft		49.2-78.7 ft		31.5 ft		32.2 ft/s		360° ASME B30.5												
354.3 ft																						
* SSL/LSL+LF ** SSL/LSL S1+LF																						
49.2 ft		68.9 ft				88.6 ft			108.3 ft													
0 lb		0-992.1 klb		0 lb		0 lb – 992,100 lb						0 lb										
15°		20°		30°		15°		20°		30°												
ft	1,000 lb										ft											
55.8	478.4	551.2	474.0	551.2	-	-	-	-	-	-	-	55.8										
59.1	451.9	551.2	447.5	551.2	551.2	544.5	-	-	-	-	-	59.1										
62.3	428.8	551.2	423.3	551.2	551.2	544.5	-	-	489.4	489.4	-	62.3										
65.6	405.7	551.2	399.0	551.2	551.2	544.5	-	-	489.4	489.4	-	65.6										
68.9	386.9	551.2	380.3	551.2	551.2	536.8	374.8	337.3	489.4	483.9	390.2	-	68.9									
72.2	368.2	551.2	361.6	551.2	551.2	529.1	372.6	335.1	489.4	478.4	386.5	-	72.2									
75.5	349.4	551.2	342.8	551.2	551.2	521.4	370.4	332.9	489.4	472.9	382.9	-	75.5									
78.7	330.7	551.2	324.1	551.2	551.2	513.7	368.2	330.7	489.4	467.4	379.2	240.3	385.8	372.6	295.4	-	308.6	306.4	-	-	78.7	
85.3	302.0	551.2	295.4	551.2	544.5	499.3	363.8	326.3	486.1	453.1	368.2	238.1	385.8	360.5	289.9	-	307.5	298.7	231.5	-	85.3	
91.9	273.4	551.2	266.8	551.2	537.9	485.0	359.4	321.9	482.8	438.7	357.1	235.9	385.8	348.3	284.4	-	183.0	306.4	291.0	231.5	-	91.9
98.4	251.3	551.2	244.7	549.0	526.9	472.9	354.9	317.5	470.7	424.4	348.3	230.4	375.9	337.3	276.7	180.2	304.2	282.2	225.4	-	98.4	
101.7	240.3	551.2	233.7	547.8	521.4	466.8	352.7	315.3	465.7	417.2	343.9	227.6	370.9	331.8	272.8	178.9	303.1	277.8	222.4	141.1	101.7	
111.5	211.1	551.2	203.9	536.8	502.7	448.6	346.1	307.5	447.5	397.9	330.7	221.6	356.0	317.5	261.2	174.2	295.4	264.6	213.8	138.3	111.5	
124.7	178.0	550.1	170.9	511.5	476.2	426.6	337.3	297.6	422.2	375.9	314.2	214.4	336.2	299.8	248.0	167.0	280.0	248.0	202.8	132.3	124.7	
137.8	148.1	532.8	141.5	484.3	453.4	407.1	328.5	288.1	399.0	356.4	299.8	206.9	317.5	282.9	236.6	159.8	263.8	234.4	192.2	126.0	137.8	
150.9	117.9	509.3	111.3	460.8	434.3	388.0	319.7	277.8	377.0	337.3	286.6	199.5	299.8	266.8	224.9	153.2	249.1	222.7	181.9	120.2	150.9	
164.0	95.5	488.7	88.7	438.7	416.7	371.8	309.4	270.4	357.9	321.1	273.4	193.6	285.1	255.0	214.6	147.3	234.4	210.9	173.1	115.7	164.0	
177.2	75.4	465.2	68.6	418.1	400.5	357.1	299.8	263.1	340.2	305.7	261.6	187.8	271.2	243.2	204.7	141.8	221.6	199.9	164.6	111.4	177.2	
190.3	57.8	438.7	50.9	399.0	385.8	343.9	291.0	255.7	324.1	291.0	251.3	181.9	257.9	231.5	195.1	136.7	210.5	189.6	156.5	107.1	190.3	
203.4	43.5	402.0	36.7	384.3	372.6	332.2	283.7	248.4	310.9	279.3	242.5	176.7	246.2	221.9	187.0	132.3	200.3	180.0	149.9	103.3	203.4	
216.5	30.6	368.9	23.7	362.3	357.1	321.9	276.3	242.5	299.1	268.2	233.7	171.6	235.2	212.4	179.7	128.2	190.7	171.2	143.7	99.8	216.5	
229.7	19.0	339.5	12.1	332.9	339.5	313.1	269.0	238.1	288.8	257.9	224.9	166.4	224.9	202.8	173.1	124.6	181.9	163.1	137.8	96.6	229.7	
236.2	13.9	326.3	-	320.4	326.3	308.2	266.8	235.9	283.3	253.5	221.6	164.2	220.5	198.6	169.8	122.9	178.2	160.3	135.1	95.1	236.2	
242.8	-	314.2	-	307.9	314.2	302.9	263.5	233.7	277.8	249.1	218.3	162.6	216.1	194.7	166.4	121.3	174.5	156.7	132.5	93.6	242.8	
255.9	-	291.0	-	285.1	291.7	286.6	257.2	230.0	268.2	241.0	211.6	159.1	207.6	187.0	160.6	117.6	167.6	149.9	127.5	90.9	255.9	
269.0	-	269.0	-	264.6	271.2	264.6	251.3	227.1	257.9	233.7	205.0	155.4	199.5	179.7	155.4	114.6	160.9	143.3	122.4	88.4	269.0	
282.2	-	251.3	-	245.4	252.1	246.9	246.9	222.7	247.7	226.3	199.2	152.5	192.9	173.8	151.0	112.4	155.1	138.2	118.7	86.3	282.2	
295.3	-	234.1	-	227.4	234.8	229.3	235.9	218.7	235.2	219.4	193.6	149.5	186.7	167.9	146.6	110.5	149.5	133.4	115.1	84.4	295.3	
301.8	-	225.6	-	219.0	227.1	220.5	227.1	216.9	227.8	216.1	191.1	148.1	183.7	165.0	144.4	109.6	147.0	131.2	113.3	83.4	301.8	
305.1	-	221.4	-	214.8	223.2	216.1	-	216.1	224.1	214.4	189.8	147.3	182.2	163.5	143.3	109.1	145.7	130.1	112.4	82.9	305.1	
308.4	-	217.2	-	210.5	219.4	211.6	-	-	220.5	212.7	188.5	146.6	180.8	162.0	142.2	108.7	144.4	129.0	111.3	82.5	308.4	
321.5	-	196.6	-	190.1	198.8	191.1	-	-	203.6	198.4	184.1	145.0	175.6	157.6	138.5	107.1	140.0	125.3	108.9	81.0	321.5	
324.8	-	191.4	-	184.9	193.6	185.9	-	-	199.3	193.5	183.0	144.4	174.3	156.5	137.6	106.7	138.9	124.4	108.2	80.7	324.8	
334.6	-	176.7	-	170.1	178.6	171.1	-	-	185.9	179.3	175.6	-	170.9	153.2	135.2	105.6	135.6	121.6	106.3	79.7	334.6	
341.2	-	167.2	-	160.6	168.7	161.4	-	-	176.7	170.1	169.4	-	168.7	151.0	133.7	105.0	133.4	118.9	104.9	79.1	341.2	
344.5	-	162.4	-	155.8	-	156.5	-	-	172.1	165.5	166.3	-	167.6	149.9	133.0	104.7	132.3	118.9	104.3	78.8	344.5	
347.8	-	157.6	-	151.0	-	-	-	-	167.6	160.9	163.1	-	166.4	148.8	132.3	-	131.2	117.9	103.6	78.5	347.8	
354.3	-	151.0	-	146.1	-	-	-	-	158.7	152.5	154.3	-	161.7	147.3	131.2	-	129.7	116.5	102.6	78.2	354.3	
360.9	-	-	-	141.1	-	-	-	-	149.9	144.0	145.5	-	156.9	145.9	130.1	-	128.2	115.0	101.6	77.8	360.9	
364.2	-	-	-	-	-	-	-	-	145.5	140.2	141.1	-	154.5	145.1	129.5	-	127.5	114.3	101.0	-	364.2	
374.0	-	-	-	-	-	-	-	-	137.8	132.8	-	-	144.0	137.1	128.1	-	125.3	112.4	99.7	-	374.0	
380.6	-	-	-	-	-	-	-	-	133.4	127.9	-	-	136.0	130.1	127.2	-	123.8	111.2	98.9	-	380.6	
383.9	-	-	-	-	-	-	-	-	-	-	-	-	133.4	127.9	126.8	-	123.1	110.6	98.5	-	383.9	
387.1	-	-	-	-	-	-	-	-	-	-	-	-	131.2	125.7	-	-	122.4	110.0	98.1	-	387.1	
393.7	-	-	-	-	-	-	-	-	-	-	-	-	126.8	120.9	-	-	121.3	109.0	97.5	-	393.7	
400.3	-	-	-	-	-	-	-	-	-	-	-	-	-	115.7	-	-	120.2	108.0	96.9	-	400.3	
403.5	-	-	-	-	-	-	-	-	-	-	-	-	-	-	-	-	119.6	107.4	96.6	-	403.5	
413.4	-	-	-	-	-	-	-	-	-	-	-	-	-	-	-	-	114.3	105.3	-	-	413.4	
419.9	-	-	-	-	-	-	-	-	-	-	-	-	-	-	-	-	109.6	103.6	-	-	419.9	

	0 lb	176,400 lb	352,800 lb	529,200 lb	705,600 lb	882,000 lb	992,100 lb
--	------	------------	------------	------------	------------	------------	------------

Operation

SSL/LSL+LF SSL/LSL S1+LF

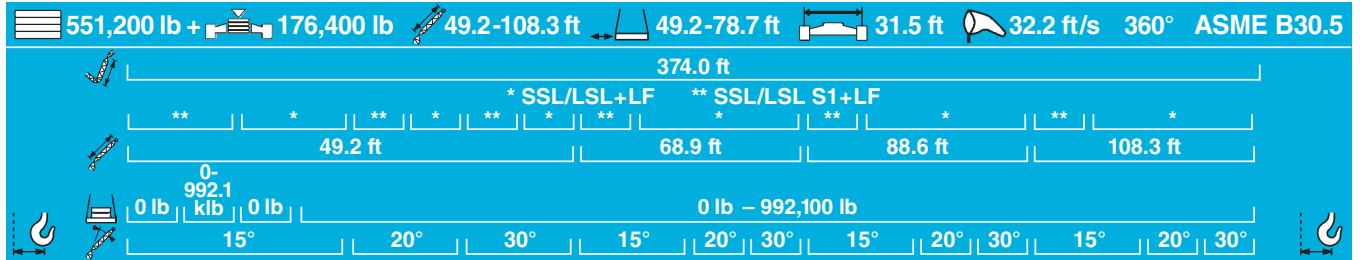

ft	1,000 lb												ft		
59.1	436.5	551.2	434.3	546.7	-	-	-	-	-	-	-	-	-	-	59.1
62.3	413.4	551.2	411.2	546.7	542.3	502.7	-	-	-	-	-	-	-	-	62.3
65.6	390.2	551.2	388.0	546.7	542.3	502.7	-	-	465.2	445.3	-	-	-	-	65.6
68.9	372.0	551.2	369.8	546.7	541.8	502.7	372.6	343.9	465.2	445.3	401.2	-	-	-	68.9
72.2	353.8	551.2	351.6	546.7	541.2	502.7	371.1	342.5	465.2	445.3	399.8	-	-	-	72.2
78.7	317.5	551.2	315.3	546.7	540.1	502.7	368.2	339.5	465.2	445.3	396.8	-	370.4	366.0	78.7
82.0	303.7	551.2	301.5	546.7	537.9	501.6	365.4	337.3	465.2	445.3	391.9	253.5	370.4	364.9	82.0
85.3	289.9	551.2	287.7	546.7	535.7	500.4	362.7	335.1	465.2	445.3	386.9	251.3	370.4	363.8	85.3
88.6	276.1	551.2	273.9	546.7	533.5	499.3	359.9	332.9	465.2	445.3	382.0	249.1	370.4	362.7	88.6
91.9	262.4	551.2	260.1	546.7	531.3	498.2	357.1	330.7	465.2	445.3	377.0	246.9	370.4	361.6	91.9
98.4	241.4	551.2	238.7	546.7	523.6	492.7	353.8	326.3	463.0	438.7	368.2	241.4	367.1	353.8	98.4
105.0	220.5	551.2	217.2	546.7	515.9	487.2	350.5	321.9	463.0	432.1	359.4	235.9	363.8	346.1	105.0
111.5	202.8	551.2	199.5	546.7	504.9	476.2	346.1	318.6	450.8	420.0	348.3	230.4	356.0	336.2	111.5
124.7	166.4	551.2	163.1	531.3	481.7	455.3	337.3	312.0	426.6	396.8	328.5	220.5	339.5	317.5	124.7
137.8	135.6	541.6	132.4	504.9	460.0	435.8	329.2	303.5	404.2	377.7	311.6	212.0	322.6	299.1	137.8
150.9	111.3	522.5	108.5	480.6	440.9	416.7	321.9	293.2	383.6	357.1	295.4	203.9	306.4	280.0	150.9
164.0	88.8	498.2	85.8	460.0	423.3	400.5	313.1	284.4	364.5	341.0	282.2	197.3	291.7	265.3	164.0
177.2	68.8	469.6	65.6	444.6	407.1	382.9	304.2	275.6	347.6	324.8	269.7	190.7	277.8	251.3	177.2
190.3	51.1	434.3	47.8	429.9	392.4	368.2	295.4	266.8	332.9	308.6	257.9	184.1	264.6	238.1	190.3
203.4	36.9	397.6	33.6	394.6	379.2	354.9	288.1	259.4	318.2	293.9	247.7	178.9	252.8	227.8	203.4
216.5	23.9	363.8	20.5	361.1	360.1	342.2	280.7	252.2	305.7	281.3	238.1	173.8	241.0	217.9	216.5
226.4	15.1	340.6	11.7	337.3	341.3	332.9	275.2	246.9	298.0	273.4	231.5	169.9	232.2	210.7	226.4
229.7	12.1	332.9	-	330.7	335.1	328.5	273.4	244.7	295.4	269.0	229.3	168.7	229.3	208.3	229.7
242.8	-	307.9	-	305.7	310.1	306.4	267.9	240.7	284.4	258.7	223.3	164.9	221.2	199.5	242.8
255.9	-	285.1	-	282.9	286.6	284.4	261.6	235.2	275.6	249.1	216.1	161.3	213.1	191.8	255.9
269.0	-	264.6	-	262.4	264.6	262.4	255.7	229.3	266.8	240.3	209.4	157.6	205.0	185.2	269.0
282.2	-	245.4	-	243.2	246.9	244.7	244.0	226.3	247.7	233.0	203.6	154.0	197.7	178.6	282.2
295.3	-	228.5	-	226.3	230.0	227.8	230.4	220.8	230.4	223.8	198.0	151.5	191.1	172.3	295.3
308.4	-	213.8	-	211.6	213.8	211.6	215.0	212.7	215.0	212.7	192.9	148.8	185.2	166.4	308.4
315.0	-	206.1	-	202.6	207.2	203.7	208.3	206.1	208.3	206.1	190.7	147.7	182.4	164.2	315.0
318.2	-	201.4	-	198.0	202.5	199.1	-	201.7	204.8	202.3	189.6	147.2	181.1	163.1	318.2
321.5	-	196.8	-	193.3	197.9	194.4	-	201.2	198.4	188.5	146.6	179.7	162.0	141.8	321.5
334.6	-	178.2	-	175.3	179.3	176.4	-	185.6	182.2	180.0	144.8	174.9	157.6	138.5	334.6
337.9	-	173.6	-	170.9	174.7	172.0	-	181.3	178.0	176.9	144.4	173.6	156.5	137.8	337.9
347.8	-	159.8	-	157.6	160.9	158.7	-	168.7	165.3	167.6	-	169.8	153.2	135.6	347.8
354.3	-	151.4	-	148.8	152.1	149.9	-	160.2	157.3	159.1	-	163.9	151.4	134.1	354.3
357.6	-	147.2	-	144.4	-	145.5	-	156.0	153.2	154.9	-	160.9	150.5	133.4	357.6
360.9	-	142.9	-	140.0	-	141.1	-	151.8	149.2	150.6	-	158.0	149.5	132.6	360.9
367.5	-	135.6	-	133.4	-	-	-	143.3	141.1	142.2	-	152.1	147.7	131.2	367.5
374.0	-	-	-	129.0	-	-	-	135.6	133.0	134.5	-	144.8	140.7	130.1	374.0
377.3	-	-	-	126.8	-	-	-	131.7	129.0	130.6	-	141.1	137.2	129.5	377.3
380.6	-	-	-	-	-	-	-	127.9	125.7	126.8	-	137.4	133.7	129.0	380.6
387.1	-	-	-	-	-	-	-	123.5	121.3	-	-	130.1	126.8	127.9	387.1
393.7	-	-	-	-	-	-	-	120.2	116.8	-	-	122.9	119.7	121.3	393.7
397.0	-	-	-	-	-	-	-	-	114.6	-	-	119.6	117.4	117.9	397.0
400.3	-	-	-	-	-	-	-	-	-	-	-	117.6	115.4	115.7	400.3
406.8	-	-	-	-	-	-	-	-	-	-	-	-	113.5	111.3	406.8
413.4	-	-	-	-	-	-	-	-	-	-	-	-	-	106.3	413.4
416.7	-	-	-	-	-	-	-	-	-	-	-	-	103.8	-	416.7
426.5	-	-	-	-	-	-	-	-	-	-	-	-	-	102.5	426.5
433.1	-	-	-	-	-	-	-	-	-	-	-	-	-	97.9	433.1
436.4	-	-	-	-	-	-	-	-	-	-	-	-	-	92.2	436.4



Operation

SSL/LSL+LF SSL/LSL S1+LF

551,200 lb + 176,400 lb 49.2-108.3 ft 49.2-78.7 ft 31.5 ft 32.2 ft/s 360° ASME B30.5

393.7 ft

* SSL/LSL+LF ** SSL/LSL S1+LF

49.2 ft 68.9 ft 88.6 ft 108.3 ft

0 lb 0-992.1 klb 0 lb 0 lb - 992,100 lb

15° 20° 30° 15° 20° 30° 15° 20° 30° 15° 20° 30°

ft	1,000 lb												ft										
59.1	418.9	526.9	418.9	522.5	-	-	-	-	-	-	-	-	-	-	-	-	-	-	-	-	-	-	59.1
62.3	396.8	526.9	396.8	522.5	507.1	502.7	-	-	-	-	-	-	-	-	-	-	-	-	-	-	-	-	62.3
65.6	374.8	526.9	374.8	522.5	507.1	502.7	-	-	440.9	436.5	-	-	-	-	-	-	-	-	-	-	-	-	65.6
72.2	339.5	526.9	339.5	522.5	507.1	502.7	368.2	346.1	440.9	436.5	407.9	-	352.7	348.3	-	-	-	-	-	-	-	-	72.2
78.7	304.2	526.9	304.2	522.5	507.1	502.7	366.0	343.9	440.9	436.5	407.9	-	352.7	348.3	-	-	284.4	282.2	-	-	-	-	78.7
82.0	291.0	526.9	291.0	522.5	507.1	501.0	363.8	341.7	440.9	436.5	402.3	255.7	352.7	348.3	315.3	-	284.4	281.6	-	-	-	-	82.0
85.3	277.8	526.9	277.8	522.5	507.1	499.3	361.6	339.5	440.9	436.5	396.8	252.8	352.7	348.3	310.1	-	284.4	281.1	-	-	-	-	85.3
88.6	264.6	526.9	264.6	522.5	507.1	497.7	359.4	337.3	440.9	436.5	391.3	249.9	352.7	348.3	305.0	-	284.4	280.5	246.9	-	-	-	88.6
91.9	251.3	526.9	251.3	522.5	507.1	496.0	357.1	335.1	440.9	436.5	385.8	246.9	352.7	348.3	299.8	-	284.4	280.0	244.7	-	-	-	91.9
95.1	240.9	526.9	240.9	521.9	504.9	493.3	354.9	333.4	440.9	436.5	380.3	244.2	352.7	347.8	295.4	186.3	284.4	280.0	240.9	-	-	-	95.1
98.4	230.4	526.9	230.4	521.4	502.7	490.5	352.7	331.8	440.9	436.5	374.8	241.4	352.7	347.2	291.0	184.5	284.4	280.0	237.0	-	-	-	98.4
105.0	209.4	526.9	209.4	520.3	498.2	485.0	348.3	328.5	440.9	436.5	363.8	235.9	352.7	346.1	282.2	180.8	284.4	280.0	229.3	143.3	-	-	105.0
111.5	192.4	526.9	191.8	518.1	493.8	479.5	345.0	325.2	436.5	429.9	353.8	231.5	351.6	340.6	273.4	176.4	283.3	276.7	222.1	140.0	-	-	111.5
124.7	158.2	524.7	157.6	508.2	482.8	467.4	338.4	317.5	424.4	412.3	334.0	222.7	342.8	324.1	257.9	168.7	278.9	264.6	208.9	133.4	-	-	124.7
137.8	128.8	517.4	128.8	486.5	468.9	448.3	331.4	307.9	408.6	390.2	316.7	214.2	327.0	304.2	244.7	162.0	269.7	248.4	197.7	127.5	-	-	137.8
150.9	104.1	511.5	104.3	471.8	454.2	427.7	324.1	297.6	388.0	368.2	302.0	206.1	310.9	286.6	231.5	155.4	257.9	233.7	187.4	122.4	-	-	150.9
164.0	81.3	495.3	81.6	453.4	436.5	408.6	315.3	287.3	370.4	349.1	288.8	198.8	296.2	271.9	221.2	149.5	244.7	220.5	178.6	117.2	-	-	164.0
177.2	61.0	468.9	61.4	435.8	419.6	391.0	307.2	277.8	354.2	331.4	276.3	192.2	282.2	257.9	211.6	144.4	231.9	208.3	170.1	112.7	-	-	177.2
190.3	43.2	427.7	43.7	421.1	403.4	374.8	299.8	269.0	339.5	315.3	264.6	186.3	269.0	244.7	202.8	140.0	219.4	197.3	162.0	108.9	-	-	190.3
203.4	29.0	391.0	29.4	388.7	384.3	361.6	292.5	261.6	326.3	302.0	254.3	181.1	257.2	233.0	194.7	135.6	209.1	187.8	155.4	105.2	-	-	203.4
216.5	15.4	357.1	16.1	357.9	359.4	348.3	284.4	255.3	313.1	289.5	244.7	176.0	246.2	222.7	187.0	131.2	199.5	179.0	148.8	101.7	-	-	216.5
219.8	-	350.0	13.0	350.5	351.6	345.0	282.2	254.0	309.7	286.6	242.5	174.7	243.6	220.5	185.2	130.1	197.3	177.0	147.2	100.9	-	-	219.8
229.7	-	328.5	-	328.5	328.5	328.5	277.8	249.1	302.0	277.8	235.9	170.9	235.9	212.7	179.7	126.8	190.7	170.9	142.2	98.3	-	-	229.7
242.8	-	303.5	-	303.5	303.5	303.5	271.9	243.2	291.7	266.0	227.1	166.4	227.1	204.7	173.1	124.1	182.6	164.5	137.2	95.5	-	-	242.8
255.9	-	280.0	-	280.0	280.7	280.7	266.0	238.1	277.8	255.7	219.7	162.4	218.6	196.9	167.2	120.9	175.3	157.6	132.3	92.7	-	-	255.9
269.0	-	257.9	-	257.9	260.1	260.1	260.1	233.7	260.1	246.9	213.8	158.7	210.5	189.6	162.0	117.9	168.7	151.0	127.9	90.2	-	-	269.0
282.2	-	240.3	-	240.3	241.0	241.0	242.5	229.3	241.0	238.1	208.0	155.8	203.2	183.0	156.9	115.0	162.8	145.7	123.5	88.0	-	-	282.2
295.3	-	223.2	-	223.8	224.0	225.4	221.6	224.3	225.8	202.1	152.9	146.2	196.2	176.7	152.1	112.4	156.9	140.0	119.5	85.9	-	-	295.3
308.4	-	207.2	-	208.3	208.3	208.3	209.4	210.5	209.4	209.4	196.2	149.9	189.6	170.9	147.7	110.2	151.0	135.6	115.7	84.0	-	-	308.4
321.5	-	191.8	-	192.9	193.6	194.7	195.8	195.5	195.5	191.8	147.9	146.6	184.5	165.8	144.4	108.9	146.6	131.2	112.8	82.4	-	-	321.5
328.1	-	184.1	-	185.2	186.3	187.4	188.5	188.5	188.5	189.6	146.6	146.6	181.9	163.1	142.2	108.0	144.4	129.0	111.3	81.6	-	-	328.1
331.4	-	179.9	-	181.0	181.9	182.1	-	184.1	184.6	184.6	185.9	146.2	179.9	162.0	141.5	107.6	143.3	128.1	110.7	81.2	-	-	331.4
334.6	-	175.6	-	176.7	177.5	177.8	-	-	180.8	180.8	182.2	145.9	177.8	160.9	140.7	107.2	142.2	127.1	110.0	80.9	-	-	334.6
347.8	-	158.7	-	159.8	159.8	160.9	-	-	165.3	165.3	167.6	144.4	169.8	156.5	137.8	105.6	137.8	123.5	107.4	79.4	-	-	347.8
351.1	-	154.7	-	155.8	155.8	156.9	-	-	161.5	161.5	163.7	143.3	166.3	155.4	137.1	105.3	136.9	125.5	106.7	79.1	-	-	351.1
360.9	-	142.6	-	143.7	143.7	144.8	-	-	149.9	149.9	152.1	-	155.8	152.1	134.8	104.4	134.1	119.8	104.9	78.3	-	-	360.9
367.5	-	134.5	-	135.6	135.6	136.7	-	-	142.2	142.2	144.4	-	148.8	149.9	133.4	103.8	132.3	117.9	103.6	77.8	-	-	367.5
370.7	-	130.6	-	131.5	-	132.6	-	-	138.3	138.5	140.7	-	145.3	146.4	132.8	103.6	131.5	117.4	103.1	77.6	-	-	370.7
374.0	-	126.8	-	127.5	-	128.6	-	-	134.5	134.8	137.1	-	141.8	142.9	132.3	-	130.8	116.8	102.6	77.5	-	-	374.0
377.3	-	123.5	-	123.5	-	124.6	-	-	130.6	131.2	133.4	-	138.3	139.4	131.7	-	130.1	116.0	102.1	77.3	-	-	377.3
387.1	-	116.8	-	116.8	-	-	-	-	120.2	120.2	122.4	-	127.9	129.0	130.1	-	127.9	113.5	100.5	76.7	-	-	387.1
390.4	-	114.6	-	114.5	-	-	-	-	116.6	116.8	118.5	-	124.6	125.3	126.8	-	126.8	113.2	100.1	76.5	-	-	390.4
393.7	-	112.4	-	112.1	-	-	-	-	114.1	114.1	114.6	-	121.3	121.6	123.5	-	125.7	112.8	99.8	-	-	-	393.7
397.0	-	-	-	109.8	-	-	-	-	112.1	112.1	112.4	-	117.9	117.9	120.2	-	122.6	112.4	99.4	-	-	-	397.0
400.3	-	-	-	-	-	-	-	-	110.2	110.2	-	-	114.6	114.9	116.8	-	119.6	111.7	99.0	-	-	-	400.3
406.8	-	-	-	-	-	-	-	-	106.3	106.3	-	-	108.0	108.7	110.2	-	113.5	110.2	98.1	-	-	-	406.8
413.4	-	-	-	-	-	-	-	-	-	-	-	-	103.7	104.0	104.9	-	107.5	105.5	97.4	-	-	-	413.4
416.7	-	-	-	-	-	-	-	-	-	-	-	-	101.6	102.2	103.0	-	104.5	103.2	97.1	-	-	-	416.7
426.5	-	-	-	-	-	-	-	-	-	-	-	-	-	95.5	96.8	-	-	97.7	96.8	96.1	-	-	426.5
433.1	-	-	-	-	-	-	-	-	-	-	-	-	-	90.2	90.8	-	-	93.5	93.1	94.1	-	-	433.1
439.6	-	-	-	-	-	-	-	-	-	-	-	-	-	-	-	-	-	89.3	89.4	-	-	-	439.6
446.2	-	-	-	-	-	-	-	-	-	-	-	-	-	-	-	-	-	85.1	85.8	-	-	-	446.2
452.8	-	-	-	-	-	-	-	-	-	-	-	-	-	-	-	-	-	80.0	-	-	-	-	452.8

0 lb 176,400 lb 352,800 lb 529,200 lb 705,600 lb 882,000 lb 992,100 lb

Operation

SSL/LSL+LF SSL/LSL S1+LF

551,200 lb + 176,400 lb 49.2-108.3 ft 49.2-78.7 ft 31.5 ft 32.2 ft/s 360° ASME B30.5

413.4 ft

* SSL/LSL+LF ** SSL/LSL S1+LF

49.2 ft 68.9 ft 88.6 ft 108.3 ft

0 lb 0 lb 0 lb - 992,100 lb

15° 20° 30° 15° 20° 30° 15° 20° 30° 15° 20° 30°

ft	1,000 lb												ft										
62.3	385.8	458.6	383.6	471.8	-	-	-	-	-	-	-	-	-	-	-	-	-	-	-	-	-	-	62.3
65.6	363.8	458.6	363.8	471.8	438.7	454.2	-	-	-	-	-	-	-	-	-	-	-	-	-	-	-	-	65.6
68.9	347.2	458.6	346.7	471.8	438.7	454.2	-	-	388.0	401.2	-	-	-	-	-	-	-	-	-	-	-	-	68.9
72.2	330.7	458.6	329.6	471.8	438.7	454.2	359.4	341.7	387.3	401.2	-	-	-	-	-	-	-	-	-	-	-	-	72.2
75.5	314.2	458.6	312.5	471.8	438.7	454.2	358.3	341.7	386.5	401.2	379.2	-	324.1	324.1	-	-	-	-	-	-	-	-	75.5
78.7	297.6	458.6	295.4	471.8	438.7	454.2	357.1	341.7	385.8	401.2	379.2	-	324.1	324.1	-	-	-	-	-	-	-	-	78.7
82.0	284.4	458.6	282.2	471.8	438.7	454.2	354.9	340.1	385.8	401.2	379.2	-	324.1	324.1	310.9	-	264.6	264.6	-	-	-	-	82.0
85.3	271.2	458.6	269.0	471.8	438.7	454.2	352.7	338.4	385.8	401.2	379.2	253.5	324.1	324.1	307.9	-	264.6	264.6	-	-	-	-	85.3
91.9	244.7	458.6	242.5	471.8	438.7	454.2	348.3	335.1	385.8	401.2	379.2	249.1	324.1	324.1	302.0	-	264.6	264.6	244.7	-	-	-	91.9
95.1	234.5	458.6	232.3	471.2	438.7	454.2	346.7	333.4	385.8	400.7	376.4	246.4	324.1	324.1	307.6	187.4	264.6	264.0	240.9	-	-	-	95.1
98.4	224.3	458.6	222.1	470.7	438.7	454.2	345.0	331.8	385.8	400.1	373.7	243.6	324.1	324.1	293.2	185.2	264.6	263.5	237.0	-	-	-	98.4
108.3	195.4	458.6	193.5	467.9	438.7	453.1	340.1	326.8	385.3	398.5	363.2	235.3	324.1	324.1	280.5	178.9	264.6	262.4	226.2	141.1	-	-	108.3
111.5	186.8	458.6	185.2	466.3	438.7	451.9	338.4	325.2	384.7	397.9	358.3	232.6	324.1	324.1	276.7	176.9	264.6	262.4	223.2	139.6	-	-	111.5
124.7	154.3	457.5	153.2	459.7	438.7	446.4	331.8	318.6	383.6	393.5	339.5	223.2	323.0	321.9	261.2	169.8	263.5	261.2	211.1	133.4	-	-	124.7
137.8	126.7	442.4	125.6	442.4	432.1	434.3	324.8	310.1	380.7	385.8	322.6	215.7	316.7	310.1	247.7	163.1	259.4	252.1	199.9	127.5	-	-	137.8
150.9	102.3	425.5	101.2	427.7	418.9	416.7	317.5	299.8	374.8	377.0	306.4	208.3	306.4	291.0	235.9	156.5	253.5	235.9	189.6	122.4	-	-	150.9
164.0	79.5	406.4	78.4	406.4	401.2	402.7	311.6	291.0	360.1	357.9	293.2	201.0	293.2	276.3	224.9	150.6	243.2	224.1	180.8	117.9	-	-	164.0
177.2	59.2	391.7	58.1	394.6	379.2	385.1	305.7	282.2	343.9	340.2	280.7	194.4	280.7	262.4	215.0	145.5	233.0	212.7	172.3	113.7	-	-	177.2
190.3	41.4	381.4	40.3	381.4	370.4	374.8	299.8	273.4	335.1	324.1	269.0	188.5	269.0	249.1	206.1	141.1	222.7	201.7	164.2	109.6	-	-	190.3
203.4	27.0	366.0	26.1	367.4	354.2	359.4	293.9	266.0	317.5	309.4	258.7	183.4	258.7	237.4	198.0	136.7	213.1	192.2	157.6	105.9	-	-	203.4
216.5	13.7	354.9	12.8	354.9	346.1	349.1	287.7	259.4	308.6	296.2	249.1	178.2	246.9	227.1	190.3	132.6	203.9	183.0	151.2	102.4	-	-	216.5
229.7	-	326.3	-	326.3	328.5	326.3	282.2	253.5	295.4	284.4	240.3	173.1	238.1	218.3	183.0	129.0	195.1	175.3	144.4	99.2	-	-	229.7
242.8	-	301.3	-	301.3	302.0	301.3	274.8	247.7	288.1	272.6	231.5	168.7	230.8	209.4	176.4	125.3	187.0	167.9	139.3	96.3	-	-	242.8
255.9	-	277.8	-	277.8	278.5	278.5	267.5	241.8	275.6	262.4	224.1	164.6	223.0	201.4	170.5	122.0	179.3	160.9	134.5	93.5	-	-	255.9
269.0	-	255.7	-	255.7	257.9	257.9	260.1	235.9	257.9	253.5	218.3	160.9	215.0	194.0	165.3	119.0	172.0	154.3	130.1	91.1	-	-	269.0
282.2	-	238.1	-	238.1	238.8	238.8	241.0	231.5	240.3	237.4	211.6	158.0	207.6	187.4	160.2	116.4	166.4	148.8	125.7	88.7	-	-	282.2
295.3	-	220.5	-	221.2	222.1	221.9	223.8	222.1	223.2	222.1	205.6	155.1	200.6	181.0	155.4	113.5	160.2	143.3	121.6	86.6	-	-	295.3
308.4	-	206.1	-	205.0	207.2	206.1	208.3	207.2	207.2	207.2	200.6	152.1	194.0	175.3	151.0	111.3	154.3	138.9	117.9	84.7	-	-	308.4
321.5	-	192.2	-	191.8	193.3	192.2	194.4	193.3	193.3	193.3	191.8	149.9	188.9	170.1	147.3	109.7	149.9	134.5	115.0	82.9	-	-	321.5
334.6	-	177.5	-	177.1	178.6	177.5	180.2	178.9	179.7	179.3	180.8	147.7	180.8	165.0	143.7	108.1	145.5	130.1	112.1	81.4	-	-	334.6
341.2	-	169.8	-	169.0	170.9	169.8	173.1	171.6	173.1	172.3	174.2	146.6	175.3	162.4	141.8	107.3	143.3	127.9	110.6	80.7	-	-	341.2
347.8	-	162.0	-	160.9	163.1	162.0	-	164.2	166.4	165.3	167.6	145.5	169.8	159.8	140.0	106.5	141.1	125.7	109.1	80.0	-	-	347.8
360.9	-	146.6	-	145.5	147.7	146.6	-	-	151.8	150.6	152.9	144.0	156.5	152.5	137.1	105.0	137.4	122.7	106.6	78.9	-	-	360.9
367.5	-	138.9	-	137.8	140.0	138.9	-	-	144.4	143.3	145.5	143.3	149.9	148.8	135.6	104.3	135.6	121.3	105.4	78.3	-	-	367.5
374.0	-	131.7	-	130.6	132.3	131.7	-	-	137.2	136.7	138.5	-	143.3	142.2	134.1	103.8	133.9	119.8	104.3	77.7	-	-	374.0
383.9	-	120.7	-	119.6	121.3	120.7	-	-	126.8	126.8	127.9	-	133.4	132.3	131.9	103.2	131.2	117.6	102.6	77.0	-	-	383.9
387.1	-	116.8	-	115.7	117.9	116.8	-	-	123.5	123.5	124.6	-	130.1	129.0	131.2	-	130.1	116.8	102.1	76.7	-	-	387.1
393.7	-	111.0	-	109.7	111.3	110.2	-	-	117.0	116.8	117.9	-	123.8	122.7	124.8	-	125.3	115.1	101.2	76.5	-	-	393.7
400.3	-	107.4	-	105.9	-	-	-	-	110.5	110.1	111.3	-	117.6	116.5	118.6	-	120.5	113.8	100.3	76.2	-	-	400.3
403.5	-	105.6	-	104.0	-	-	-	-	107.3	106.7	108.0	-	114.5	113.4	115.5	-	118.1	113.1	99.9	76.1	-	-	403.5
406.8	-	103.8	-	102.1	-	-	-	-	104.5	103.4	104.7	-	111.3	110.2	112.4	-	115.7	112.4	99.4	-	-	-	406.8
413.4	-	-	-	96.8	-	-	-	-	100.2	98.9	99.4	-	105.2	104.3	106.3	-	110.0	107.5	98.6	-	-	-	413.4
426.5	-	-	-	-	-	-	-	-	91.7	91.7	-	-	95.5	92.8	93.9	-	98.5	97.7	97.0	-	-	-	426.5
433.1	-	-	-	-	-	-	-	-	86.4	85.5	-	-	91.9	89.5	90.2	-	92.9	92.1	92.3	-	-	-	433.1
439.6	-	-	-	-	-	-	-	-	-	-	-	-	87.3	86.2	-	-	89.2	86.5	87.6	-	-	-	439.6
446.2	-	-	-	-	-	-	-	-	-	-	-	-	82.7	82.0	-	-	86.0	82.7	83.8	-	-	-	446.2
449.5	-	-	-	-	-	-	-	-	-	-	-	-	-	79.1	-	-	83.9	80.8	82.2	-	-	-	449.5
452.8	-	-	-	-	-	-	-	-	-	-	-	-	-	-	-	-	81.8	79.0	-	-	-	-	452.8
459.3	-	-	-	-	-	-	-	-	-	-	-	-	-	-	-	-	77.6	75.3	-	-	-	-	459.3
465.9	-	-	-	-	-	-	-	-	-	-	-	-	-	-	-	-	-	71.7	-	-	-	-	465.9
469.2	-	-	-	-	-	-	-	-	-	-	-	-	-	-	-	-	-	69.0	-	-	-	-	469.2



Operation

SSL/LSL+LF SSL/LSL S1+LF

551,200 lb + 176,400 lb 49.2-108.3 ft 49.2-78.7 ft 31.5 ft 32.2 ft/s 360° ASME B30.5

433.1 ft

* SSL/LSL+LF ** SSL/LSL S1+LF

49.2 ft 68.9 ft 88.6 ft 108.3 ft

0-992.1 klb 0 lb 0 lb 0 lb - 992,100 lb

15° 20° 30° 15° 20° 30° 15° 20° 30° 15° 20° 30°

ft	1,000 lb												ft		
62.3	370.4	427.7	366.0	410.1	-	-	-	-	-	-	-	-	-	-	62.3
65.6	350.5	427.7	354.9	410.1	-	-	-	-	-	-	-	-	-	-	65.6
68.9	334.0	427.7	337.9	410.1	410.1	374.8	-	-	363.8	330.7	-	-	-	-	68.9
72.2	317.5	427.7	320.8	410.1	410.1	374.8	-	-	363.8	330.7	-	-	-	-	72.2
75.5	300.9	427.7	303.7	410.1	410.1	374.8	350.5	315.3	363.8	330.7	297.6	-	306.4	275.6	75.5
78.7	284.4	427.7	286.6	410.1	410.1	374.8	350.5	315.3	363.8	330.7	297.6	-	306.4	275.6	78.7
82.0	271.7	427.7	273.9	409.5	410.1	374.8	348.9	314.7	363.8	330.7	297.6	-	306.4	275.6	82.0
85.3	259.0	427.7	261.2	409.0	410.1	374.8	347.2	314.2	363.8	330.7	297.6	238.1	306.4	275.6	85.3
91.9	233.7	427.7	235.9	407.9	410.1	374.8	343.9	313.1	363.8	330.7	297.6	238.1	306.4	275.6	91.9
98.4	213.3	427.7	216.1	404.5	410.1	373.7	341.7	309.7	363.8	329.6	297.6	234.8	306.4	275.6	98.4
108.3	184.6	427.1	187.9	399.6	410.1	371.5	337.9	304.8	363.8	327.4	297.1	229.3	305.9	274.5	108.3
111.5	176.4	426.6	179.7	397.9	410.1	370.4	336.2	303.1	363.8	326.3	296.5	227.1	305.3	273.4	111.5
124.7	145.5	424.4	149.4	391.3	410.1	364.9	329.6	297.6	362.7	319.7	292.1	219.9	304.2	267.9	124.7
137.8	116.6	418.1	123.5	382.9	407.1	357.1	323.3	292.5	359.4	310.9	285.1	213.8	303.5	260.9	137.8
150.9	87.5	407.9	99.2	372.6	401.2	348.3	317.5	286.6	354.9	302.0	277.8	207.2	302.0	253.5	150.9
164.0	69.4	391.7	76.4	354.9	380.7	338.0	311.6	279.3	347.6	291.7	270.4	200.6	296.2	244.7	164.0
177.2	51.4	372.6	56.1	333.6	363.0	321.1	305.7	272.6	327.0	280.7	262.4	194.7	288.1	235.9	177.2
190.3	33.5	363.8	38.4	321.9	352.7	299.8	299.8	266.8	319.7	269.0	253.5	189.6	277.8	228.3	190.3
203.4	19.3	346.1	24.1	300.7	338.8	291.0	293.9	260.9	303.5	258.7	244.7	184.5	264.6	219.7	203.4
210.0	12.1	341.7	17.0	295.4	335.1	286.6	291.0	257.9	299.8	253.5	240.3	181.9	257.9	216.1	210.0
213.3	-	338.0	13.7	293.2	332.9	281.1	289.9	254.6	297.6	248.0	238.8	180.8	256.1	213.8	213.3
216.5	-	334.4	-	291.0	330.7	275.6	288.8	253.5	295.4	242.5	237.4	179.7	254.3	211.6	216.5
229.7	-	319.7	-	282.2	321.9	266.8	284.4	249.1	286.6	231.5	222.7	175.3	246.9	203.9	229.7
242.8	-	294.7	-	269.7	296.9	257.9	278.5	242.5	278.5	224.1	214.6	170.9	236.6	197.3	242.8
255.9	-	271.9	-	262.4	273.4	251.3	268.2	236.6	268.2	212.0	206.5	166.8	227.8	185.2	255.9
269.0	-	251.3	-	253.5	251.3	246.9	253.5	233.7	253.5	206.1	199.5	163.1	220.5	177.5	269.0
282.2	-	231.5	-	235.9	233.7	233.7	235.9	229.3	234.4	201.7	195.8	159.5	212.4	173.1	282.2
295.3	-	215.0	-	219.4	216.8	220.5	219.0	221.2	217.2	196.2	191.4	156.7	205.0	166.1	295.3
308.4	-	199.5	-	203.9	200.6	205.0	202.8	206.1	201.7	192.9	188.5	153.2	198.4	163.1	308.4
321.5	-	186.3	-	190.0	186.7	191.1	188.1	192.2	187.8	187.0	184.8	151.0	188.1	160.6	321.5
334.6	-	172.3	-	176.0	172.7	177.1	173.8	178.6	174.2	177.8	177.5	148.8	176.7	158.7	334.6
347.8	-	157.6	-	162.0	158.7	163.1	159.8	165.3	160.9	165.3	166.4	146.6	164.2	156.5	347.8
354.3	-	149.9	-	154.7	151.4	155.8	152.1	157.6	154.0	158.4	159.8	145.9	157.6	154.0	354.3
360.9	-	142.7	-	147.3	144.0	148.4	-	149.9	147.0	151.4	153.2	145.1	151.0	151.4	360.9
374.0	-	128.6	-	133.4	129.7	134.5	-	-	133.4	137.8	140.0	140.0	138.2	142.6	374.0
380.6	-	121.6	-	126.8	122.7	127.9	-	-	126.8	131.2	133.4	135.6	131.9	136.5	380.6
387.1	-	114.6	-	120.2	115.7	121.3	-	-	120.2	124.6	126.8	-	125.7	130.1	387.1
400.3	-	101.6	-	106.9	102.5	107.9	-	-	107.7	112.5	114.1	-	113.6	118.3	400.3
406.8	-	96.3	-	100.3	96.8	101.2	-	-	101.4	106.5	107.8	-	107.6	112.4	406.8
410.1	-	94.5	-	97.8	-	98.3	-	-	98.4	103.5	104.8	-	104.7	109.5	410.1
413.4	-	92.6	-	96.0	-	-	-	-	95.4	100.5	101.7	-	101.9	106.6	413.4
416.7	-	90.7	-	94.2	-	-	-	-	92.4	97.4	98.7	-	99.0	103.7	416.7
419.9	-	88.8	-	92.4	-	-	-	-	89.6	94.4	95.6	-	96.1	100.8	419.9
426.5	-	-	-	88.8	-	-	-	-	86.0	89.1	89.7	-	90.4	95.0	426.5
429.8	-	-	-	86.0	-	-	-	-	83.8	87.3	88.0	-	87.6	92.2	429.8
439.6	-	-	-	-	-	-	-	-	77.5	81.9	-	-	82.3	83.8	439.6
446.2	-	-	-	-	-	-	-	-	73.2	78.3	-	-	78.9	80.2	446.2
449.5	-	-	-	-	-	-	-	-	-	75.4	-	-	76.6	78.4	449.5
452.8	-	-	-	-	-	-	-	-	-	-	-	-	74.3	76.6	452.8
459.3	-	-	-	-	-	-	-	-	-	-	-	-	69.7	72.9	459.3
465.9	-	-	-	-	-	-	-	-	-	-	-	-	-	69.2	465.9
469.2	-	-	-	-	-	-	-	-	-	-	-	-	-	66.6	469.2
479.0	-	-	-	-	-	-	-	-	-	-	-	-	-	-	479.0
485.6	-	-	-	-	-	-	-	-	-	-	-	-	-	-	485.6

	0 lb	176,400 lb	352,800 lb	529,200 lb	705,600 lb	882,000 lb	992,100 lb
--	------	------------	------------	------------	------------	------------	------------

Operation

SSL/LSL+LF SSL/LSL S1+LF

551,200 lb + 176,400 lb 49.2-108.3 ft 49.2-78.7 ft 31.5 ft 32.2 ft/s 360° ASME B30.5

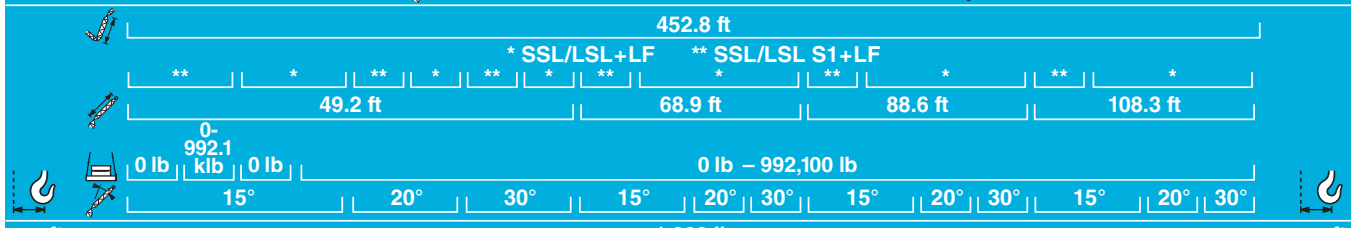

ft	1,000 lb																ft
65.6	335.1	399.0	330.7	363.8	-	-	-	-	-	-	-	-	-	-	-	-	65.6
68.9	319.1	399.0	316.4	363.2	385.8	348.3	-	-	-	-	-	-	-	-	-	-	68.9
72.2	303.1	399.0	302.0	362.7	385.8	348.3	-	-	341.7	310.9	-	-	-	-	-	-	72.2
75.5	287.2	399.0	289.4	362.1	385.8	348.3	341.7	286.6	341.7	310.9	-	-	-	-	-	-	75.5
78.7	271.2	399.0	277.8	361.6	385.8	348.3	341.7	286.6	341.7	310.9	284.4	-	288.8	262.4	-	-	78.7
85.3	246.9	399.0	253.5	359.4	385.8	346.1	339.5	285.5	341.7	308.6	284.4	-	288.8	262.4	235.9	-	85.3
88.6	234.8	399.0	241.4	358.3	385.8	345.0	338.4	284.9	341.7	307.5	284.4	240.3	288.8	262.4	235.9	-	88.6
91.9	222.7	399.0	229.3	357.1	385.8	343.9	337.3	284.4	341.7	306.4	284.4	240.3	288.8	262.4	235.9	-	91.9
95.1	212.7	398.5	219.4	355.5	385.3	342.3	336.2	283.8	341.7	304.8	283.8	239.8	288.8	261.8	235.3	-	95.1
98.4	202.8	397.9	209.4	353.8	384.7	340.6	335.1	283.3	341.7	303.1	283.3	239.8	288.8	261.2	234.8	183.0	98.4
111.5	167.0	394.6	173.6	346.1	382.5	334.0	330.7	281.1	340.6	296.5	280.0	234.8	288.8	257.9	232.6	178.0	111.5
124.7	137.2	390.2	144.4	337.3	379.2	326.3	325.2	277.8	337.3	289.9	275.6	227.1	288.8	252.4	230.4	170.9	124.7
137.8	109.3	385.8	117.0	328.5	374.8	317.5	318.9	273.4	332.9	282.9	269.7	219.0	286.6	246.2	226.3	164.6	137.8
150.9	80.9	381.4	88.6	319.7	370.4	308.6	313.1	269.0	328.5	275.6	262.4	211.6	282.2	240.3	220.5	158.7	150.9
164.0	62.8	362.3	70.5	309.4	351.3	299.8	308.6	264.6	322.6	266.8	255.0	204.3	277.8	233.0	216.1	152.9	164.0
177.2	44.8	348.3	52.6	299.1	341.7	290.3	303.5	260.1	309.4	257.9	247.7	197.7	272.6	225.6	210.9	147.7	177.2
190.3	26.9	337.3	34.8	288.8	328.5	280.0	297.6	255.7	297.6	249.1	240.3	191.8	266.8	218.3	205.0	143.3	190.3
203.4	11.9	327.4	20.6	271.2	321.9	262.4	293.2	252.8	289.9	240.3	231.5	186.7	256.5	211.6	198.4	138.9	203.4
210.0	-	319.7	13.4	264.6	317.5	257.9	291.0	251.3	284.4	235.9	227.1	184.1	251.3	208.3	195.1	136.7	210.0
216.5	-	315.3	-	259.4	307.9	254.3	288.8	242.5	277.0	230.4	224.9	181.9	248.4	205.0	192.4	134.9	216.5
229.7	-	306.4	-	249.1	302.0	246.9	284.4	235.9	271.2	218.3	218.3	176.4	242.5	197.3	186.3	131.2	229.7
242.8	-	287.3	-	239.6	285.9	234.4	278.5	225.6	260.9	211.6	205.8	172.7	230.0	191.4	180.4	127.5	242.8
255.9	-	266.8	-	230.8	267.5	227.8	266.8	218.3	254.3	203.5	199.9	168.7	224.5	180.6	174.2	124.2	255.9
269.0	-	244.7	-	224.9	246.9	220.5	249.1	213.8	246.9	196.2	194.0	164.2	219.4	174.2	167.6	121.3	269.0
282.2	-	227.1	-	219.7	227.6	215.3	229.3	208.3	229.3	190.7	185.2	161.5	213.8	169.0	160.4	118.3	282.2
295.3	-	210.2	-	211.6	211.6	209.7	212.7	203.9	212.4	185.2	180.8	158.4	207.2	161.3	156.5	115.7	295.3
308.4	-	194.0	-	200.6	196.2	201.7	197.3	197.3	196.2	180.8	176.4	155.4	198.4	157.6	152.1	113.5	308.4
321.5	-	180.0	-	186.7	181.5	187.8	183.4	187.0	181.5	176.4	172.7	152.5	184.5	154.7	148.1	111.3	321.5
334.6	-	166.4	-	173.4	167.2	174.2	169.4	175.6	167.9	170.1	168.3	149.9	171.2	152.1	145.9	109.6	334.6
347.8	-	152.1	-	160.9	153.2	160.9	155.4	163.1	155.4	162.0	163.1	147.7	158.7	149.9	144.4	108.0	347.8
360.9	-	138.2	-	147.0	139.4	147.7	141.1	149.2	142.2	149.5	150.6	145.5	145.5	147.7	141.5	106.4	360.9
367.5	-	131.2	-	140.0	132.3	141.1	134.5	142.2	135.6	143.3	144.4	144.4	138.9	146.6	140.0	105.6	367.5
374.0	-	124.6	-	133.4	125.7	134.5	-	135.6	129.0	136.9	137.8	140.0	132.6	141.1	138.5	105.0	374.0
387.1	-	111.3	-	120.2	112.4	121.3	-	-	115.7	124.6	125.7	127.9	120.2	127.9	130.1	103.6	387.1
393.7	-	105.3	-	114.1	106.3	115.1	-	-	109.9	118.6	119.8	122.4	114.6	122.4	124.2	103.2	393.7
400.3	-	99.3	-	108.0	100.2	108.9	-	-	104.1	112.7	113.9	-	109.1	116.8	118.3	102.7	400.3
413.4	-	87.2	-	95.8	88.1	96.7	-	-	92.7	101.0	102.3	-	98.1	105.9	107.2	101.9	413.4
419.9	-	82.3	-	89.8	82.7	90.7	-	-	87.0	95.2	96.6	-	92.6	100.5	102.0	-	419.9
426.5	-	78.7	-	84.9	-	85.3	-	-	81.4	89.5	90.8	-	87.1	95.0	96.8	-	426.5
433.1	-	74.1	-	81.2	-	-	-	-	75.9	84.0	85.2	-	81.8	89.7	91.5	-	433.1
439.6	-	69.6	-	77.5	-	-	-	-	72.7	78.5	79.7	-	76.5	84.4	86.2	-	439.6
446.2	-	65.0	-	73.9	-	-	-	-	69.4	75.2	75.8	-	72.5	79.1	80.9	-	446.2
452.8	-	-	-	-	-	-	-	-	65.1	71.4	-	-	68.9	74.1	75.7	-	452.8
459.3	-	-	-	-	-	-	-	-	60.8	67.7	-	-	65.3	70.3	71.0	-	459.3
462.6	-	-	-	-	-	-	-	-	-	65.8	-	-	63.5	68.7	69.4	-	462.6
465.9	-	-	-	-	-	-	-	-	-	63.9	-	-	61.7	67.2	-	-	465.9
479.0	-	-	-	-	-	-	-	-	-	-	-	-	52.7	59.6	-	-	479.0
482.3	-	-	-	-	-	-	-	-	-	-	-	-	50.3	57.7	-	-	482.3
485.6	-	-	-	-	-	-	-	-	-	-	-	-	47.8	55.8	-	-	485.6
492.1	-	-	-	-	-	-	-	-	-	-	-	-	-	-	-	-	492.1
498.7	-	-	-	-	-	-	-	-	-	-	-	-	-	-	-	-	498.7
505.3	-	-	-	-	-	-	-	-	-	-	-	-	-	-	-	-	505.3

0 lb 176,400 lb 352,800 lb 529,200 lb 705,600 lb 882,000 lb 992,100 lb

Operation

SSL/LSL+LF SSL/LSL S1+LF

551,200 lb + 176,400 lb 49.2-108.3 ft 49.2-78.7 ft 31.5 ft 32.2 ft/s 360° ASME B30.5

492.1 ft

* SSL/LSL+LF ** SSL/LSL S1+LF

49.2 ft 68.9 ft 88.6 ft 108.3 ft

0-992.1 klb 0 lb 0 lb - 992,100 lb

15° 20° 30° 15° 20° 30° 15° 20° 30° 15° 20° 30°

ft	1,000 lb												ft									
68.9	291.0	341.7	262.4	280.0	-	-	-	-	-	-	-	-	-	-	-	-	-	-	-	-	-	68.9
72.2	276.3	341.0	256.5	279.3	330.7	269.0	-	-	-	-	-	-	-	-	-	-	-	-	-	-	-	72.2
75.5	261.6	340.2	252.8	278.5	330.7	269.0	-	-	295.4	238.1	-	-	-	-	-	-	-	-	-	-	-	75.5
78.7	246.9	339.5	251.3	277.8	330.7	269.0	302.0	246.9	295.4	238.1	-	-	-	-	-	-	-	-	-	-	-	78.7
82.0	235.3	339.5	241.1	276.1	330.1	267.3	302.0	246.4	294.9	237.5	227.1	-	255.7	203.9	-	-	-	-	-	-	-	82.0
85.3	223.8	339.5	230.9	274.5	329.6	265.7	302.0	245.8	294.3	237.0	226.3	-	255.7	203.9	-	-	-	-	-	-	-	85.3
88.6	212.2	339.5	222.9	272.8	329.0	264.0	302.0	245.3	293.8	236.4	225.6	-	255.7	203.9	190.7	-	216.1	175.3	-	-	-	88.6
91.9	200.6	339.5	215.0	271.2	328.5	262.4	302.0	244.7	293.2	235.9	224.9	187.4	255.7	203.9	190.7	-	216.1	175.3	-	-	-	91.9
98.4	181.3	338.4	196.2	266.8	327.4	259.0	300.9	241.4	292.1	232.6	222.7	187.4	255.7	201.2	189.6	-	216.1	174.2	163.1	-	-	98.4
101.7	171.7	337.9	186.8	264.6	326.8	257.4	300.4	239.8	291.6	230.9	220.7	187.4	255.7	199.8	189.0	166.4	216.1	173.6	163.1	-	-	101.7
111.5	146.6	335.1	162.0	257.9	325.2	251.3	298.7	234.8	289.9	226.0	216.6	186.3	254.6	195.7	186.3	165.9	216.1	170.9	161.5	-	-	111.5
114.8	138.9	334.0	154.3	255.7	324.6	249.1	298.2	233.1	289.4	224.3	215.2	185.7	254.1	194.3	185.2	165.6	216.1	169.8	160.7	138.9	-	114.8
124.7	118.5	331.8	133.9	249.1	323.0	242.5	295.4	228.2	287.7	219.4	210.5	184.6	252.4	190.1	181.3	163.7	215.5	166.4	157.6	133.9	-	124.7
137.8	92.7	328.5	108.5	239.6	319.7	233.7	291.0	220.8	284.4	211.6	203.6	182.6	249.1	184.1	175.6	159.8	214.6	161.7	153.2	129.0	-	137.8
150.9	66.6	324.1	83.1	229.3	315.3	224.9	286.6	212.7	280.0	202.8	196.2	179.7	244.7	177.5	169.8	155.4	213.8	156.5	148.8	124.6	-	150.9
164.0	48.4	318.2	65.0	220.5	310.9	215.3	283.7	204.7	275.6	194.7	188.1	173.8	241.8	170.9	163.9	150.3	210.9	151.4	143.7	120.2	-	164.0
177.2	30.2	305.3	47.0	211.3	297.6	206.1	280.0	196.9	271.2	186.7	180.4	167.9	238.1	164.6	158.0	145.5	208.0	145.9	138.9	115.7	-	177.2
190.3	12.1	299.8	29.1	201.7	293.2	197.3	275.6	189.6	266.8	178.6	173.1	162.0	233.7	158.7	152.1	141.1	205.0	140.0	134.5	111.3	-	190.3
203.4	-	287.3	14.3	194.0	280.7	189.4	271.2	182.2	254.3	171.5	166.4	156.2	229.3	152.1	146.2	136.7	200.6	134.8	129.3	108.2	-	203.4
216.5	-	278.5	-	185.6	274.1	181.5	261.6	174.9	245.4	163.9	159.8	151.0	219.4	145.9	141.1	132.3	196.6	129.9	124.6	105.1	-	216.5
229.7	-	269.0	-	177.5	266.8	174.2	255.7	167.6	238.1	156.5	153.2	145.5	213.8	140.0	135.6	127.9	192.9	124.6	120.2	101.9	-	229.7
242.8	-	261.6	-	170.9	256.5	167.6	246.9	161.7	233.7	150.6	147.3	140.4	209.4	134.1	130.4	123.5	188.5	120.2	115.7	99.1	-	242.8
255.9	-	253.5	-	163.1	251.3	160.5	242.5	155.8	224.9	144.4	141.5	135.0	200.6	129.0	125.7	119.4	179.7	115.7	111.9	96.3	-	255.9
269.0	-	231.5	-	154.3	233.7	154.3	235.9	149.9	220.5	138.9	135.6	130.1	196.2	124.6	121.3	115.7	175.3	111.3	108.2	93.7	-	269.0
282.2	-	213.8	-	148.4	215.3	145.9	218.3	141.5	210.9	133.7	130.4	125.7	189.2	119.4	116.8	112.0	168.3	107.2	104.4	91.3	-	282.2
295.3	-	196.9	-	143.3	198.0	141.1	201.0	137.1	198.0	126.2	124.8	121.6	185.6	114.6	112.7	108.5	164.6	103.2	100.8	89.2	-	295.3
308.4	-	180.8	-	138.9	181.9	136.7	184.1	133.4	181.9	121.3	119.0	117.9	181.9	111.3	108.9	105.2	160.9	99.4	97.2	87.1	-	308.4
321.5	-	166.1	-	134.8	167.2	132.6	169.4	129.3	167.9	117.4	115.7	112.2	170.9	105.5	105.0	101.9	155.8	95.9	93.8	85.2	-	321.5
334.6	-	152.1	-	131.9	153.2	129.7	155.4	126.8	154.3	114.6	112.4	109.3	158.4	102.4	100.2	97.2	151.4	91.5	90.5	83.6	-	334.6
347.8	-	138.9	-	129.0	140.0	126.8	142.2	124.6	141.1	112.4	110.2	107.4	144.4	99.6	97.4	94.4	145.5	88.0	87.3	81.8	-	347.8
360.9	-	125.7	-	126.0	126.8	124.2	129.0	122.4	128.6	109.8	108.2	105.2	131.9	97.3	95.2	92.3	133.0	85.6	83.6	80.2	-	360.9
374.0	-	113.2	-	122.7	114.3	122.0	116.3	119.8	116.5	107.7	106.0	103.3	119.9	95.3	93.4	90.4	121.2	83.4	81.5	78.4	-	374.0
387.1	-	101.4	-	119.0	102.5	119.0	104.3	116.8	104.7	105.2	103.6	101.4	108.2	93.3	91.5	88.8	110.0	81.6	79.8	76.9	-	387.1
393.7	-	95.5	-	113.5	96.6	113.8	98.3	113.1	99.0	104.0	102.5	100.5	102.8	92.2	90.5	88.0	104.6	80.7	79.0	76.1	-	393.7
400.3	-	89.8	-	107.9	90.9	108.5	-	109.3	93.5	102.8	101.4	99.5	97.4	91.2	89.6	87.2	99.3	79.8	78.2	75.5	-	400.3
403.5	-	87.0	-	105.1	88.1	105.8	-	107.4	90.7	102.2	100.9	99.0	94.7	90.7	89.1	86.8	96.6	79.4	77.8	75.3	-	403.5
413.4	-	78.9	-	96.9	79.9	97.8	-	-	82.7	97.6	97.2	97.6	86.9	89.1	87.7	85.6	89.0	78.0	76.6	74.3	-	413.4
419.9	-	73.5	-	91.6	74.4	92.4	-	-	77.5	93.5	94.0	96.6	81.8	88.1	86.7	84.8	84.1	77.2	75.8	73.6	-	419.9
426.5	-	68.1	-	86.2	69.0	87.1	-	-	72.3	89.5	90.8	-	76.7	87.1	85.8	84.0	79.1	76.3	75.0	73.0	-	426.5
439.6	-	58.2	-	75.8	58.8	76.6	-	-	62.3	79.6	80.7	-	67.2	83.3	82.4	81.8	69.7	74.5	73.3	71.7	-	439.6
452.8	-	50.7	-	66.5	51.3	66.9	-	-	52.5	70.0	71.1	-	57.8	74.1	75.8	-	60.6	71.7	70.9	70.3	-	452.8
459.3	-	47.0	-	64.0	47.6	64.4	-	-	48.7	65.2	66.3	-	53.1	69.6	71.2	-	56.2	69.7	69.3	69.7	-	459.3
465.9	-	43.2	-	61.5	-	-	-	-	45.2	61.5	62.2	-	48.5	65.0	66.6	-	51.8	67.7	67.7	-	-	465.9
472.4	-	39.0	-	57.1	-	-	-	-	41.8	58.7	59.4	-	44.1	60.6	62.1	-	47.4	63.4	64.0	-	-	472.4
475.7	-	-	-	54.9	-	-	-	-	40.1	57.3	58.0	-	42.4	58.4	59.9	-	45.3	61.3	62.2	-	-	475.7
479.0	-	-	-	52.5	-	-	-	-	38.4	55.7	-	-	40.8	57.1	57.8	-	43.2	59.2	60.3	-	-	479.0
482.3	-	-	-	50.0	-	-	-	-	36.7	54.1	-	-	39.1	55.6	56.4	-	41.1	57.0	58.5	-	-	482.3
492.1	-	-	-	-	-	-	-	-	30.6	48.1	-	-	34.4	50.9	51.8	-	35.1	51.0	52.5	-	-	492.1
495.4	-	-	-	-	-	-	-	-	28.4	45.9	-	-	32.8	49.4	50.3	-	33.5	49.5	50.7	-	-	495.4
498.7	-	-	-	-	-	-	-	-	26.2	43.7	-	-	31.3	47.8	-	-	32.0	48.0	49.2	-	-	498.7
511.8	-	-	-	-	-	-	-	-	-	-	-	-	24.0	40.7	-	-	26.1	42.0	43.3	-	-	511.8
515.1	-	-	-	-	-	-	-	-	-	-	-	-	-	38.6	-	-	24.6	40.6	41.9	-	-	515.1
518.4	-	-	-	-	-	-	-	-	-	-	-	-	-	36.6	-	-	23.1	39.1	-	-	-	518.4
531.5	-	-	-	-	-	-	-	-	-	-	-	-	-	-	-	-	16.2	32.4	-	-	-	531.5
538.1	-	-	-	-	-	-	-	-	-	-	-	-	-	-	-	-	12.3	28.7	-	-	-	538.1

0 lb 176,400 lb 352,800 lb 529,200 lb 705,600 lb 882,000 lb 992,100 lb

LUFFING FLY JIB



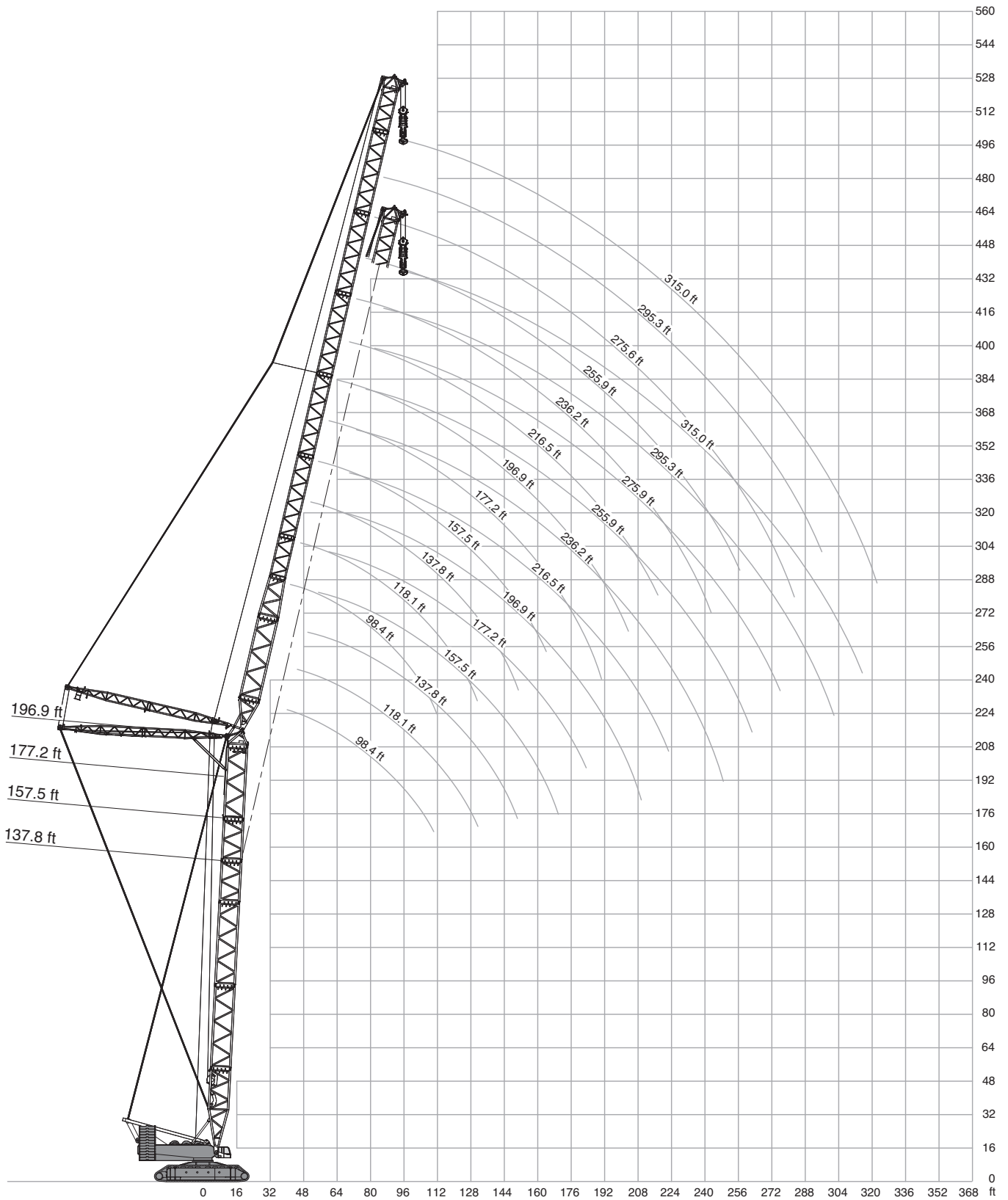

Operation

374,800 – 551,200 lb + 0–176,400 lb		31.5 ft		32.2 ft/s		360°		ASME B30.5											
137.8 ft																			
98.4 ft			118.1 ft			137.8 ft			157.5 ft			177.2 ft			196.9 ft				
87°/85° 75° 65°			87°/85° 75° 65°			87°/85° 75° 65°			87°/85° 75° 65°			87°/85° 75° 65°			87°/85° 75° 65°				
ft										1,000 lb									
45.9	747.4	-	-	-	-	-	-	-	-	-	-	-	-	-	-	-	-	-	-
49.2	698.9	-	-	672.4	-	-	-	-	-	-	-	-	-	-	-	-	-	-	-
52.5	654.8	-	-	630.5	-	-	610.7	-	-	-	-	-	-	-	-	-	-	-	-
59.1	584.2	-	-	564.4	-	-	544.5	-	-	526.9	-	-	-	-	-	-	-	-	-
62.3	553.4	-	-	533.5	-	-	518.1	-	-	500.4	-	-	485.0	-	-	-	-	-	-
65.6	524.7	-	-	507.1	-	-	491.6	-	-	476.2	-	-	460.8	-	-	445.3	-	-	-
72.2	478.4	-	-	460.8	-	-	447.5	-	-	434.3	-	-	421.1	-	-	405.7	-	-	-
78.7	436.5	-	-	423.3	-	-	410.1	-	-	396.8	-	-	385.8	-	-	372.6	-	-	-
85.3	403.4	-	-	390.2	-	-	379.2	-	-	366.0	-	-	354.9	-	-	343.9	-	-	-
91.9	366.0	319.7	-	361.6	-	-	350.5	-	-	339.5	-	-	330.7	-	-	319.7	-	-	-
98.4	332.9	291.0	-	332.9	-	-	326.3	-	-	315.3	-	-	306.4	-	-	297.6	-	-	-
105.0	304.2	264.6	-	304.2	262.4	-	304.2	-	-	295.4	-	-	286.6	-	-	277.8	-	-	-
111.5	280.0	244.7	-	280.0	242.5	-	280.0	240.3	-	275.6	-	-	269.0	-	-	260.1	-	-	-
118.1	-	224.9	-	260.1	222.7	-	257.9	220.5	-	255.7	217.2	-	251.3	-	-	244.7	-	-	-
124.7	-	209.4	-	240.3	207.2	-	240.3	206.1	-	235.9	200.6	-	235.9	197.3	-	229.3	-	-	-
131.2	-	195.1	170.9	219.4*	192.9	-	224.9	191.8	-	220.5	186.3	-	219.4	185.2	-	217.2	-	-	-
137.8	-	183.0	158.7	-	180.8	-	209.4	178.6	-	206.1	174.2	-	205.0	172.0	-	205.0	167.6	-	-
144.4	-	-	148.8	-	168.7	145.5	197.3	167.6	-	194.0	163.1	-	191.8	160.9	-	191.8	157.6	-	-
150.9	-	-	140.0	-	158.7	136.7	180.8*	156.5	-	181.9	152.1	-	180.8	151.0	-	179.7	148.8	-	-
157.5	-	-	131.2	-	149.9	129.0	-	147.7	125.7	170.9	143.3	-	169.8	141.1	-	169.8	140.0	-	-
164.0	-	-	123.5	-	-	121.3	-	138.9	117.9	162.0	134.5	112.4	159.8	133.4	-	159.8	131.2	-	-
177.2	-	-	-	-	-	107.4	-	124.6	104.7	-	120.2	99.0	143.3	117.9	96.1	142.2	116.8	-	-
190.3	-	-	-	-	-	-	-	-	93.3	-	108.2	87.5	125.7*	106.3	84.9	127.9	104.9	82.7	-
203.4	-	-	-	-	-	-	-	-	-	-	-	77.8	-	95.5	75.2	115.7	93.7	73.0	-
216.5	-	-	-	-	-	-	-	-	-	-	-	69.7	-	86.0	66.8	-	83.8	64.6	-
229.7	-	-	-	-	-	-	-	-	-	-	-	-	-	59.5	-	75.4	57.1	-	-
242.8	-	-	-	-	-	-	-	-	-	-	-	-	-	-	-	-	-	50.7	-
255.9	-	-	-	-	-	-	-	-	-	-	-	-	-	-	-	-	-	45.0	-

216.5 ft			236.2 ft			255.9 ft			275.6 ft			295.3 ft			315.0 ft				
87°/85° 75° 65°			87°/85° 75° 65°			87°/85° 75° 65°			87°/85° 75° 65°			87°/85° 75° 65°			87°/85° 75° 65°				
ft										1,000 lb									
72.2	392.4	-	-	-	-	-	-	-	-	-	-	-	-	-	-	-	-	-	-
78.7	359.4	-	-	348.3	-	-	339.5	-	-	-	-	-	-	-	-	-	-	-	-
85.3	332.9	-	-	321.9	-	-	313.1	-	-	302.0	-	-	-	-	-	-	-	-	-
91.9	308.6	-	-	297.6	-	-	291.0	-	-	280.0	-	-	273.4	-	-	251.3	-	-	-
98.4	286.6	-	-	277.8	-	-	271.2	-	-	260.1	-	-	253.5	-	-	244.7	-	-	-
111.5	249.1	-	-	242.5	-	-	235.9	-	-	227.1	-	-	220.5	-	-	213.8	-	-	-
124.7	220.5	-	-	213.8	-	-	208.3	-	-	200.6	-	-	195.1	-	-	187.4	-	-	-
137.8	196.2	-	-	189.6	-	-	185.2	-	-	178.6	-	-	173.1	-	-	166.4	-	-	-
144.4	186.3	148.8	-	179.7	-	-	175.3	-	-	168.7	-	-	163.1	-	-	156.5	-	-	-
150.9	176.4	141.1	-	169.8	134.5	-	165.3	-	-	158.7	-	-	154.3	-	-	147.7	-	-	-
164.0	156.5	125.7	-	153.2	119.0	-	148.8	115.7	-	142.2	-	-	137.8	-	-	132.3	-	-	-
177.2	140.0	113.5	-	136.7	107.4	-	134.5	103.6	-	127.9	97.2	-	124.6	93.0	-	117.9	-	-	-
190.3	125.7	101.2	-	122.4	96.3	-	121.3	93.0	-	115.7	86.6	-	112.4	82.7	-	106.5	76.5	-	-
203.4	112.4	89.9	68.8	110.2	85.8	-	109.1	83.6	-	105.4	77.4	-	101.6	73.6	-	95.9	67.5	-	-
216.5	102.5	80.0	60.4	99.6	75.8	55.8	98.3	73.9	-	95.7	69.2	-	91.9	65.5	-	86.4	59.5	-	-
229.7	89.7*	71.4	52.9	90.2	67.5	48.5	88.8	65.5	46.1	86.4	61.7	-	83.6	58.2	-	78.0	52.5	-	-
242.8	-	63.9	46.5	82.0	59.7	41.9	80.7	58.0	39.7	77.6	54.5	35.7	75.6	51.8	32.8	70.5	46.1	-	-
255.9	-	-	40.8	-	53.1	36.2	73.0	51.1	34.0	69.9	47.6	30.0	67.7	45.2	27.3	63.5	40.3	22.3	-
269.0	-	-	35.5	-	47.2	31.1	62.4*	45.4	28.9	62.8	41.7	25.1	60.6	39.2	22.3	57.3	35.1	17.6	-
282.2	-	-	-	-	26.7	-	40.1	24.5	16.8	56.4	36.4	20.5	54.2	34.0	17.9	51.4	30.2	13.4	-
295.3	-	-	-	-	22.7	-	-	20.3	-	51.7	31.7	16.5	48.5	29.1	13.7	45.4	25.8	-	-
308.4	-	-	-	-	-	-	-	16.8	-	47.3	27.3	12.8	-	24.9	-	40.3	21.4	-	-
321.5	-	-	-	-	-	-	-	-	-	43.8	23.8	-	-	20.9	-	32.6*	17.4	-	-
334.6	-	-	-	-	-	-	-	-	-	40.3	20.3	-	-	-	-	-	13.9	-	-

Main boom angle 87°, 85°, 75° and 65°, capacities for intermediate boom positions are calculated by the crane control system IC-1

* Main boom angle 85°

Operation



374,800 – 551,200 lb +		0–176,400 lb		31.5 ft		32.2 ft/s		360°		ASME B30.5							
157.5 ft																	
98.4 ft			118.1 ft			137.8 ft			157.5 ft			177.2 ft			196.9 ft		
87°/85° 75° 65°			87°/85° 75° 65°			87°/85° 75° 65°			87°/85° 75° 65°			87°/85° 75° 65°			87°/85° 75° 65°		
ft			1,000 lb														
45.9	714.3	-	-	-	-	-	-	-	-	-	-	-	-	-	-	-	-
49.2	670.2	-	-	643.8	-	-	-	-	-	-	-	-	-	-	-	-	-
52.5	630.5	-	-	606.3	-	-	-	-	-	-	-	-	-	-	-	-	-
55.8	595.2	-	-	573.2	-	-	553.4	-	-	-	-	-	-	-	-	-	-
59.1	562.2	-	-	542.3	-	-	524.7	-	-	507.1	-	-	-	-	-	-	-
62.3	533.5	-	-	515.9	-	-	498.2	-	-	482.8	-	-	467.4	-	-	-	-
65.6	507.1	-	-	489.4	-	-	474.0	-	-	458.6	-	-	445.3	-	-	-	-
72.2	460.8	-	-	445.3	-	-	432.1	-	-	418.9	-	-	405.7	-	-	392.4	-
78.7	423.3	-	-	410.1	-	-	396.8	-	-	383.6	-	-	372.6	-	-	361.6	-
85.3	390.2	-	-	377.0	-	-	366.0	-	-	354.9	-	-	343.9	-	-	332.9	-
91.9	361.6	-	-	350.5	-	-	339.5	-	-	328.5	-	-	319.7	-	-	308.6	-
98.4	330.7	277.8	-	326.3	-	-	317.5	-	-	306.4	-	-	297.6	-	-	286.6	-
105.0	304.2	255.7	-	304.2	249.1	-	295.4	-	-	286.6	-	-	277.8	-	-	269.0	-
111.5	280.0	235.9	-	280.0	233.7	-	277.8	-	-	269.0	-	-	260.1	-	-	251.3	-
118.1	251.3*	218.3	-	257.9	216.1	-	257.9	211.6	-	253.5	-	-	244.7	-	-	235.9	-
124.7	-	201.7	-	240.3	199.5	-	238.1	197.3	-	235.9	190.7	-	231.5	-	-	222.7	-
131.2	-	188.5	-	222.7	186.3	-	222.7	184.1	-	219.4	179.7	-	218.3	173.1	-	210.5	-
137.8	-	175.3	147.7	-	173.1	-	208.3	172.0	-	205.0	166.4	-	203.9	163.1	-	199.5	155.4
144.4	-	164.2	137.8	-	162.0	-	195.1	160.9	-	191.8	155.4	-	190.7	154.3	-	188.5	146.6
150.9	-	-	127.9	-	152.1	124.6	184.1	151.0	-	180.8	145.5	-	179.7	144.4	-	178.6	137.8
164.0	-	-	112.4	-	135.6	109.8	-	133.4	106.9	160.9	129.0	-	158.7	126.8	-	158.7	123.5
177.2	-	-	-	-	-	97.0	-	119.0	94.1	-	114.6	88.2	142.2	112.4	-	142.2	111.3
190.3	-	-	-	-	-	86.2	-	-	83.3	-	102.7	77.4	123.5*	100.3	74.7	126.8	99.0
203.4	-	-	-	-	-	-	-	-	74.1	-	-	68.3	-	89.5	65.7	114.6	88.0
216.5	-	-	-	-	-	-	-	-	-	-	-	60.6	-	80.2	57.8	-	78.5
229.7	-	-	-	-	-	-	-	-	-	-	-	-	-	51.1	-	70.3	48.9
242.8	-	-	-	-	-	-	-	-	-	-	-	-	-	45.2	-	-	42.8
255.9	-	-	-	-	-	-	-	-	-	-	-	-	-	-	-	-	37.5

216.5 ft			236.2 ft			255.9 ft			275.6 ft			295.3 ft			315.0 ft		
87°/85° 75° 65°			87°/85° 75° 65°			87°/85° 75° 65°			87°/85° 75° 65°			87°/85° 75° 65°			87°/85° 75° 65°		
ft			1,000 lb														
72.2	379.2	-	-	-	-	-	-	-	-	-	-	-	-	-	-	-	-
78.7	348.3	-	-	337.3	-	-	-	-	-	-	-	-	-	-	-	-	-
85.3	321.9	-	-	310.9	-	-	302.0	-	-	293.2	-	-	-	-	-	-	-
91.9	297.6	-	-	288.8	-	-	280.0	-	-	271.2	-	-	264.6	-	-	-	-
98.4	277.8	-	-	269.0	-	-	262.4	-	-	251.3	-	-	244.7	-	-	235.9	-
111.5	242.5	-	-	233.7	-	-	229.3	-	-	220.5	-	-	215.0	-	-	206.1	-
124.7	213.8	-	-	207.2	-	-	201.7	-	-	194.0	-	-	188.5	-	-	181.9	-
137.8	190.7	-	-	184.1	-	-	179.7	-	-	172.0	-	-	167.6	-	-	160.9	-
150.9	170.9	130.1	-	164.2	-	-	160.9	-	-	153.2	-	-	148.8	-	-	142.2	-
157.5	162.0	122.4	-	156.5	115.7	-	152.1	-	-	145.5	-	-	141.1	-	-	134.5	-
164.0	154.3	115.7	-	147.7	109.8	-	144.4	105.8	-	137.8	-	-	133.4	-	-	126.8	-
177.2	138.9	104.3	-	133.4	98.1	-	130.1	94.4	-	124.6	87.7	-	120.2	-	-	113.5	-
190.3	124.6	93.7	-	121.3	87.7	-	117.9	84.2	-	112.4	77.8	-	108.7	73.9	-	102.7	67.7
203.4	112.4	84.2	-	109.8	78.7	-	107.6	75.4	-	101.9	69.2	-	98.1	65.3	-	92.4	59.3
216.5	101.9	74.7	51.6	99.0	70.5	46.7	97.7	67.5	-	92.4	61.3	-	88.8	57.8	-	83.1	51.8
229.7	88.6*	66.6	44.5	89.5	62.2	39.9	88.2	60.2	37.5	84.0	54.5	-	80.5	50.9	-	75.0	45.2
242.8	-	59.1	38.6	81.4	55.1	34.0	79.8	52.9	31.5	76.3	48.3	26.7	73.0	44.8	-	67.5	39.0
255.9	-	52.7	33.3	-	48.5	28.7	72.1	46.5	26.2	69.0	42.5	21.8	66.1	39.2	-	60.8	33.5
269.0	-	-	28.4	-	42.8	23.8	61.1*	40.8	21.6	61.9	37.3	17.6	59.7	34.2	-	54.7	28.7
282.2	-	-	24.3	-	-	19.6	-	35.7	17.4	55.8	32.2	13.4	53.6	29.5	-	49.2	24.0
295.3	-	-	-	-	-	15.9	-	31.3	13.7	-	27.6	-	47.8	25.1	-	44.1	19.8
308.4	-	-	-	-	-	-	-	-	-	-	23.4	-	39.0*	20.9	-	39.5	16.1
321.5	-	-	-	-	-	-	-	-	-	-	-	-	-	17.2	-	35.1	12.6
334.6	-	-	-	-	-	-	-	-	-	-	-	-	-	13.9	-	-	-

Main boom angle 87°, 85°, 75° and 65°, capacities for intermediate boom positions are calculated by the crane control system IC-1
 * Main boom angle 85°

Operation

374,800 – 551,200 lb + 0–176,400 lb		31.5 ft		32.2 ft/s		360°		ASME B30.5									
177.2 ft																	
98.4 ft			118.1 ft			137.8 ft			157.5 ft			177.2 ft			196.9 ft		
87°/85° 75° 65°			87°/85° 75° 65°			87°/85° 75° 65°			87°/85° 75° 65°			87°/85° 75° 65°			87°/85° 75° 65°		
ft						1,000 lb											
45.9	683.4	-	-	-	-	-	-	-	-	-	-	-	-	-	-	-	-
52.5	604.1	-	-	582.0	-	-	-	-	-	-	-	-	-	-	-	-	-
55.8	571.0	-	-	551.2	-	-	533.5	-	-	-	-	-	-	-	-	-	-
59.1	542.3	-	-	522.5	-	-	504.9	-	-	487.2	-	-	-	-	-	-	-
65.6	489.4	-	-	471.8	-	-	458.6	-	-	443.1	-	-	429.9	-	-	-	-
72.2	445.3	-	-	432.1	-	-	418.9	-	-	403.4	-	-	392.4	-	-	379.2	-
78.7	410.1	-	-	396.8	-	-	383.6	-	-	372.6	-	-	361.6	-	-	348.3	-
85.3	379.2	-	-	366.0	-	-	354.9	-	-	343.9	-	-	332.9	-	-	321.9	-
91.9	350.5	-	-	339.5	-	-	330.7	-	-	319.7	-	-	308.6	-	-	299.8	-
98.4	328.5	-	-	315.3	-	-	306.4	-	-	297.6	-	-	288.8	-	-	277.8	-
105.0	302.0	242.5	-	295.4	-	-	286.6	-	-	277.8	-	-	269.0	-	-	260.1	-
111.5	277.8	227.1	-	277.8	218.3	-	269.0	-	-	260.1	-	-	253.5	-	-	244.7	-
118.1	249.1*	209.4	-	255.7	205.0	-	253.5	197.3	-	244.7	-	-	238.1	-	-	229.3	-
124.7	-	194.0	-	238.1	191.8	-	238.1	185.2	-	231.5	-	-	224.9	-	-	217.2	-
131.2	-	180.8	-	222.7	178.6	-	220.5	175.3	-	218.3	166.4	-	212.7	-	-	203.9	-
137.8	-	168.7	-	200.6*	166.4	-	207.2	164.2	-	203.9	157.6	-	200.6	151.0	-	192.9	-
144.4	-	157.6	-	-	155.4	-	194.0	153.2	-	190.7	148.8	-	189.6	142.2	-	183.0	134.5
150.9	-	147.7	115.7	-	145.5	-	183.0	143.3	-	179.7	138.9	-	178.6	134.5	-	174.2	126.8
157.5	-	-	108.5	-	136.7	105.2	165.3*	135.6	-	168.7	130.1	-	167.6	127.9	-	165.3	120.2
164.0	-	-	101.4	-	129.0	98.1	-	126.8	-	158.7	122.4	-	157.6	120.2	-	157.6	113.5
177.2	-	-	89.3	-	-	86.2	-	113.5	83.1	136.7*	108.5	-	141.1	106.0	-	141.1	102.5
190.3	-	-	-	-	-	76.1	-	-	73.0	-	96.1	67.0	121.3*	93.9	64.2	126.8	92.4
203.4	-	-	-	-	-	-	-	-	64.6	-	86.0	58.6	-	83.6	55.8	113.5	82.0
216.5	-	-	-	-	-	-	-	-	57.3	-	-	51.4	-	74.5	48.5	-	73.0
229.7	-	-	-	-	-	-	-	-	-	-	-	45.2	-	-	42.3	-	65.0
242.8	-	-	-	-	-	-	-	-	-	-	-	-	-	-	36.8	-	58.2
255.9	-	-	-	-	-	-	-	-	-	-	-	-	-	-	32.4	-	29.8
269.0	-	-	-	-	-	-	-	-	-	-	-	-	-	-	-	-	25.6



216.5 ft			236.2 ft			255.9 ft			275.6 ft			295.3 ft			315.0 ft		
87°/85° 75° 65°			87°/85° 75° 65°			87°/85° 75° 65°			87°/85° 75° 65°			87°/85° 75° 65°			87°/85° 75° 65°		
ft						1,000 lb											
72.2	366.0	-	-	-	-	-	-	-	-	-	-	-	-	-	-	-	-
78.7	335.1	-	-	324.1	-	-	-	-	-	-	-	-	-	-	-	-	-
85.3	310.9	-	-	299.8	-	-	293.2	-	-	282.2	-	-	-	-	-	-	-
91.9	288.8	-	-	277.8	-	-	271.2	-	-	262.4	-	-	255.7	-	-	-	-
98.4	269.0	-	-	260.1	-	-	253.5	-	-	244.7	-	-	235.9	-	-	227.1	-
111.5	233.7	-	-	227.1	-	-	220.5	-	-	212.7	-	-	207.2	-	-	199.5	-
124.7	207.2	-	-	200.6	-	-	195.1	-	-	187.4	-	-	183.0	-	-	175.3	-
137.8	185.2	-	-	178.6	-	-	174.2	-	-	166.4	-	-	162.0	-	-	154.3	-
150.9	166.4	-	-	159.8	-	-	155.4	-	-	148.8	-	-	144.4	-	-	137.8	-
157.5	157.6	112.4	-	151.0	-	-	147.7	-	-	141.1	-	-	136.7	-	-	130.1	-
164.0	149.9	106.3	-	143.3	99.6	-	140.0	-	-	133.4	-	-	129.0	-	-	122.4	-
177.2	135.6	95.0	-	130.1	88.6	-	125.7	84.9	-	120.2	78.3	-	115.7	-	-	110.2	-
190.3	123.5	84.9	-	117.9	78.9	-	114.6	75.4	-	108.5	69.0	-	104.7	65.0	-	98.8	-
203.4	111.3	76.3	-	107.1	70.3	-	104.1	67.0	-	98.1	60.8	-	94.6	57.1	-	88.8	50.9
216.5	101.2	68.6	42.1	97.9	62.8	-	94.8	59.7	-	89.1	53.6	-	85.3	50.0	-	79.8	43.9
229.7	87.1*	61.3	36.2	88.8	56.0	30.6	86.4	53.1	-	80.7	47.2	-	77.4	43.7	-	71.9	37.7
242.8	-	54.2	30.4	80.5	50.0	25.6	78.9	47.2	22.7	73.4	41.2	-	69.9	37.9	-	64.6	32.0
255.9	-	48.1	25.6	-	43.9	20.7	71.2	41.7	18.3	66.8	35.9	-	63.3	32.6	-	58.0	26.9
269.0	-	-	21.2	-	38.4	16.5	59.5*	36.2	13.9	60.6	31.1	-	57.3	27.8	-	52.0	22.3
282.2	-	-	17.2	-	33.5	12.6	-	31.3	-	54.9	26.7	-	51.8	23.6	-	46.7	18.1
295.3	-	-	-	-	-	-	-	27.1	-	-	22.7	-	47.0	19.4	-	41.7	14.1
308.4	-	-	-	-	-	-	-	-	-	-	19.0	-	37.7*	15.9	-	37.0	-
321.5	-	-	-	-	-	-	-	-	-	-	15.4	-	-	12.3	-	33.1	-

Main boom angle 87°, 85°, 75° and 65°, capacities for intermediate boom positions are calculated by the crane control system IC-1

* Main boom angle 85°

Operation

SW

374,800 – 551,200 lb +  0–176,400 lb		 31.5 ft		 32.2 ft/s		360°		ASME B30.5									
196.9 ft																	
98.4 ft			118.1 ft			137.8 ft			157.5 ft			177.2 ft			196.9 ft		
87°/85° 75° 65°			87°/85° 75° 65°			87°/85° 75° 65°			87°/85° 75° 65°			87°/85° 75° 65°			87°/85° 75° 65°		
ft						1,000 lb											
45.9	654.8	-	-	-	-	-	-	-	-	-	-	-	-	-	-	-	-
52.5	579.8	-	-	560.0	-	-	-	-	-	-	-	-	-	-	-	-	-
55.8	549.0	-	-	529.1	-	-	511.5	-	-	-	-	-	-	-	-	-	-
59.1	520.3	-	-	502.7	-	-	487.2	-	-	-	-	-	-	-	-	-	-
62.3	493.8	-	-	478.4	-	-	463.0	-	-	447.5	-	-	-	-	-	-	-
65.6	471.8	-	-	456.4	-	-	440.9	-	-	425.5	-	-	412.3	-	-	-	-
72.2	429.9	-	-	416.7	-	-	403.4	-	-	390.2	-	-	377.0	-	-	366.0	-
78.7	396.8	-	-	381.4	-	-	370.4	-	-	359.4	-	-	348.3	-	-	337.3	-
85.3	366.0	-	-	352.7	-	-	343.9	-	-	330.7	-	-	321.9	-	-	310.9	-
91.9	339.5	-	-	328.5	-	-	319.7	-	-	308.6	-	-	299.8	-	-	288.8	-
98.4	317.5	-	-	306.4	-	-	297.6	-	-	286.6	-	-	277.8	-	-	269.0	-
111.5	275.6	211.6	-	269.0	-	-	262.4	-	-	251.3	-	-	244.7	-	-	235.9	-
118.1	244.7*	198.4	-	253.5	189.6	-	246.9	-	-	238.1	-	-	229.3	-	-	222.7	-
124.7	-	185.2	-	235.9	178.6	-	231.5	170.9	-	224.9	-	-	217.2	-	-	209.4	-
137.8	-	159.8	-	198.4*	157.6	-	206.1	152.1	-	201.7	144.4	-	195.1	-	-	187.4	-
144.4	-	149.9	-	-	147.7	-	192.9	144.4	-	189.6	136.7	-	185.2	130.1	-	177.5	-
150.9	-	140.0	-	-	137.8	-	180.8	136.7	-	177.5	129.0	-	175.3	122.4	-	168.7	115.7
157.5	-	-	94.8	-	130.1	-	163.1*	127.9	-	167.6	122.4	-	166.4	115.7	-	159.8	109.1
164.0	-	-	88.4	-	122.4	-	-	120.2	-	157.6	114.6	-	156.5	110.2	-	152.1	103.2
177.2	-	-	77.2	-	-	74.1	-	106.0	71.0	134.5*	100.8	-	140.0	98.3	-	138.9	92.4
190.3	-	-	-	-	-	64.6	-	94.4	61.7	-	89.1	55.3	125.7	86.6	-	125.7	82.9
203.4	-	-	-	-	-	56.9	-	-	53.8	-	79.1	47.6	-	76.7	45.0	113.5	74.7
216.5	-	-	-	-	-	-	-	-	47.2	-	-	41.0	-	68.1	38.4	97.4*	66.8
229.7	-	-	-	-	-	-	-	-	-	-	-	35.5	-	60.8	32.6	-	59.3
242.8	-	-	-	-	-	-	-	-	-	-	-	30.6	-	-	27.6	-	52.5
255.9	-	-	-	-	-	-	-	-	-	-	-	-	-	-	23.4	-	21.2
269.0	-	-	-	-	-	-	-	-	-	-	-	-	-	-	-	-	17.2
282.2	-	-	-	-	-	-	-	-	-	-	-	-	-	-	-	-	13.9

216.5 ft											
87°/85° 75° 65°											
ft		1,000 lb									
78.7	324.1	-	-	-	-	-	-	-	-	-	-
85.3	299.8	-	-	-	-	-	-	-	-	-	-
91.9	277.8	-	-	-	-	-	-	-	-	-	-
98.4	257.9	-	-	-	-	-	-	-	-	-	-
111.5	227.1	-	-	-	-	-	-	-	-	-	-
124.7	200.6	-	-	-	-	-	-	-	-	-	-
137.8	178.6	-	-	-	-	-	-	-	-	-	-
150.9	160.9	-	-	-	-	-	-	-	-	-	-
157.5	152.1	101.0	-	-	-	-	-	-	-	-	-
164.0	144.4	95.2	-	-	-	-	-	-	-	-	-
177.2	131.2	84.7	-	-	-	-	-	-	-	-	-
190.3	119.0	75.6	-	-	-	-	-	-	-	-	-
203.4	109.1	67.5	-	-	-	-	-	-	-	-	-
216.5	99.9	60.2	-	-	-	-	-	-	-	-	-
229.7	84.9*	53.8	25.4	-	-	-	-	-	-	-	-
242.8	-	47.8	20.7	-	-	-	-	-	-	-	-
255.9	-	42.5	16.8	-	-	-	-	-	-	-	-
269.0	-	37.5	13.0	-	-	-	-	-	-	-	-

Main boom angle 87°, 85°, 75° and 65°, capacities for intermediate boom positions are calculated by the crane control system IC-1

* Main boom angle 85°

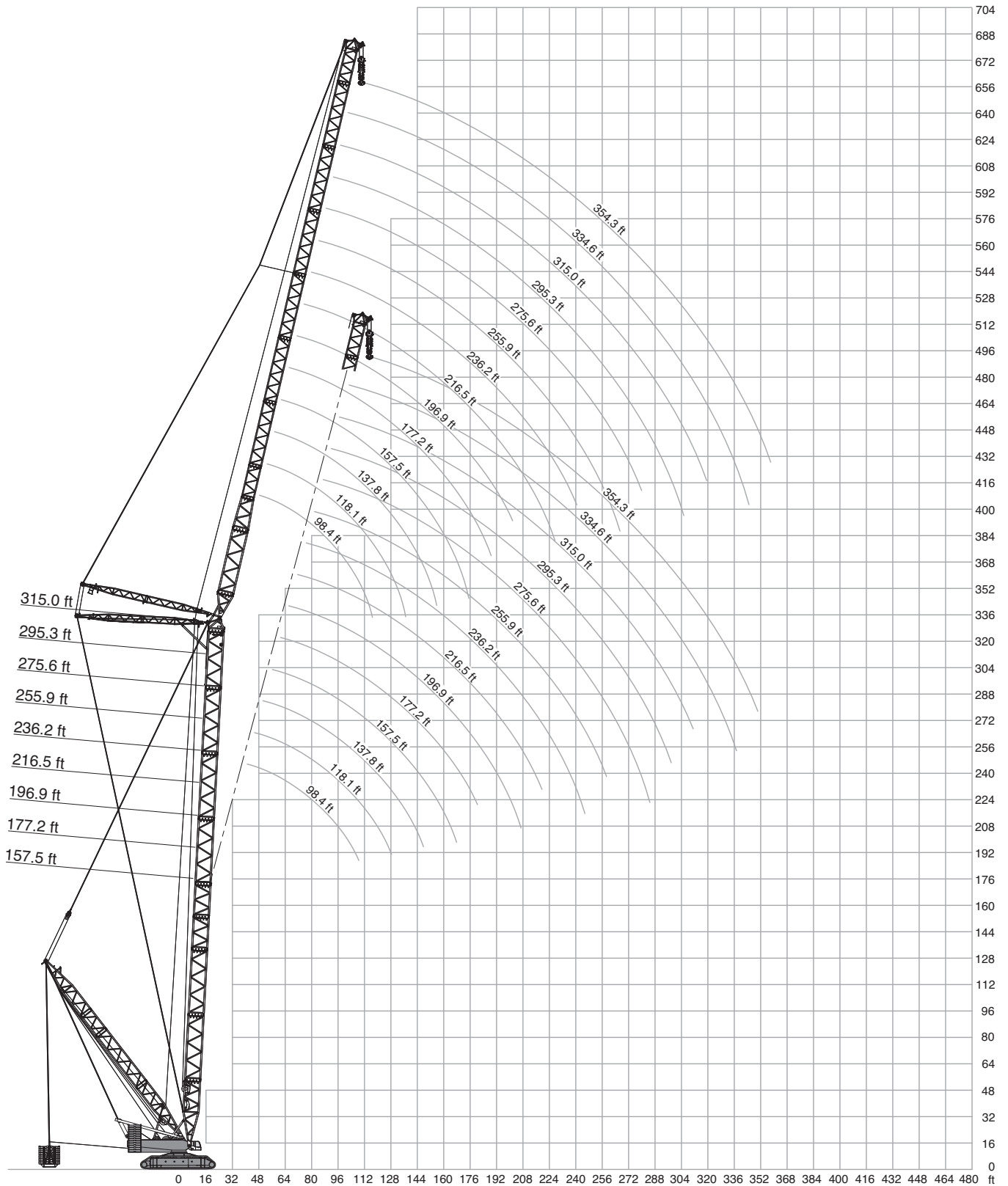

Operation

SWSL, SFSL

374,800 – 551,200 lb + 0 – 176,400 lb 49.2–78.7 ft 31.5 ft 32.2 ft/s 360° ASME B30.5									
157.5 ft + 118.1 ft					157.5 ft + 196.9 ft				
SWSL					SFSL				
0 lb					176,400 lb – 992,100 lb				
87°/85° 87°/85° 75° 65° 55° 45° 15°					87°/85° 87°/85° 75° 65° 55° 45° 15°				
1,000 lb					1,000 lb				
49.2	751.8*	1067.0*	-	-	-	-	-	-	-
52.5	707.7*	1051.6*	-	-	-	-	-	-	-
59.1	632.7*	1104.5	-	-	-	-	-	-	-
62.3	601.9*	1104.5	-	-	-	-	-	1029.6	-
65.6	573.2*	1093.5	-	-	-	-	-	1029.6	-
72.2	522.5*	1067.0	-	-	-	-	-	1029.6	-
78.7	476.2*	1038.4	-	-	-	-	-	1029.6	-
85.3	431.0*	961.2	-	-	-	-	-	1029.6	-
91.9	392.4*	862.0	-	-	-	-	-	1022.9	-
98.4	359.4*	780.4	-	-	-	-	-	994.3	-
105.0	330.7*	712.1	937.0	-	-	-	-	929.2	-
111.5	305.3*	654.8	879.6	-	-	-	-	864.2	-
124.7	263.5*	562.2	780.4	-	-	-	-	758.4	-
131.2	245.8*	524.7	725.3	-	-	-	-	716.5	-
137.8	-	-	665.8	-	-	-	-	674.6	-
150.9	-	-	571.0	608.5	-	-	-	604.1	-
164.0	-	-	498.2	553.4	-	-	-	544.5	-
177.2	-	-	-	507.1	-	-	-	478.4	-
190.3	-	-	-	467.4	414.5	-	-	421.1	-
203.4	-	-	-	-	382.5	-	-	370.4	-
216.5	-	-	-	-	-	-	-	337.3	-
229.7	-	-	-	-	-	-	-	293.2	-
242.8	-	-	-	-	-	-	-	253.5	-
255.9	-	-	-	-	-	-	-	213.8	-

157.5 ft + 157.5 ft									
1,000 lb									
59.1	593.0*	811.3*	-	-	-	-	-	-	-
65.6	537.9*	806.9*	-	-	-	-	-	-	-
72.2	491.6*	833.3	-	-	-	-	-	-	-
78.7	451.9*	831.1	-	-	-	-	-	791.5	-
85.3	418.9*	824.5	-	-	-	-	-	791.5	-
91.9	386.9*	809.1	-	-	-	-	-	791.5	-
98.4	353.8*	791.5	-	-	-	-	-	791.5	-
111.5	300.9*	694.5	-	-	-	-	-	791.5	-
124.7	259.0*	593.0	773.8	-	-	-	-	765.0	-
137.8	226.0*	515.9	690.0	-	-	-	-	679.0	-
150.9	199.5*	454.2	604.1	-	-	-	-	608.5	-
164.0	177.3*	403.4	524.7	-	-	-	-	549.0	-
177.2	-	-	460.8	500.4	-	-	-	498.2	-
190.3	-	-	410.1	460.8	-	-	-	449.7	-
203.4	-	-	-	425.5	-	-	-	399.0	-
216.5	-	-	-	394.6	346.1	-	-	354.9	-
229.7	-	-	-	-	320.8	-	-	315.3	-
242.8	-	-	-	-	299.8	-	-	291.0	-
255.9	-	-	-	-	-	252.4	-	255.7	-
269.0	-	-	-	-	-	235.9	-	224.9	-
282.2	-	-	-	-	-	-	-	194.0	-
295.3	-	-	-	-	-	-	-	163.1	-

157.5 ft + 236.2 ft									
1,000 lb									
78.7	400.1*	476.2*	-	-	-	-	-	-	-
85.3	370.4*	471.8*	-	-	-	-	-	-	-
91.9	343.9*	476.2	-	-	-	-	-	-	-
98.4	320.8*	476.2	-	-	-	-	-	463.0	-
111.5	282.2*	469.6	-	-	-	-	-	463.0	-
124.7	245.8*	458.6	-	-	-	-	-	463.0	-
137.8	214.3*	449.7	-	-	-	-	-	463.0	-
150.9	187.8*	438.7	-	-	-	-	-	460.8	-
157.5	176.4*	424.4	451.9	-	-	-	-	458.6	-
164.0	165.8*	400.1	451.9	-	-	-	-	456.4	-
177.2	147.0*	358.3	449.7	-	-	-	-	443.1	-
190.3	131.2*	324.1	405.7	-	-	-	-	429.9	-
203.4	117.3*	293.2	363.8	-	-	-	-	403.4	-
216.5	105.2*	267.9	328.5	379.2	-	-	-	379.2	-
229.7	94.4*	244.7	297.6	352.7	-	-	-	354.9	-
242.8	84.9*	223.8	271.2	328.5	-	-	-	319.7	-
255.9	-	-	248.0	298.7	-	-	-	286.6	-
269.0	-	-	227.1	272.3	-	-	-	257.9	-
282.2	-	-	-	249.1	234.8	-	-	233.7	-
295.3	-	-	-	228.2	220.5	-	-	218.3	-
308.4	-	-	-	-	209.2	-	-	196.2	-
321.5	-	-	-	-	198.2	168.9	-	174.2	-
334.6	-	-	-	-	-	159.0	-	153.2	-
347.8	-	-	-	-	-	149.7	-	133.4	-
360.9	-	-	-	-	-	-	-	112.4	-
374.0	-	-	-	-	-	-	-	92.6	-

* Main boom angle 87°

Main boom angle 87°, 85°, 75°, 65°, 55° and 45°, capacities for intermediate boom positions are calculated by the crane control system IC-1

	0 lb	176,400 lb	352,800 lb	529,200 lb	705,600 lb	882,000 lb	992,100 lb
--	------	------------	------------	------------	------------	------------	------------

Operation

SWSL, SFSL

374,800–551,200 lb + 0–176,400 lb 49.2–78.7 ft 31.5 ft 32.2 ft/s 360° ASME B30.5

157.5 ft + 275.6 ft

ft	SWSL						SFSL
	0 lb	176,400 lb – 992,100 lb					
	87°/85°	87°/85°	75°	65°	55°	45°	15°
	1,000 lb						
85.3	347.2*	362.7*	-	-	-	-	-
91.9	325.2*	361.6*	-	-	-	-	-
98.4	304.2*	358.3*	-	-	-	-	-
105.0	285.5*	361.6	-	-	-	-	-
111.5	266.8*	359.4	-	-	-	-	352.7
124.7	235.9*	354.9	-	-	-	-	350.5
137.8	209.9*	349.4	-	-	-	-	350.5
150.9	183.4*	343.9	-	-	-	-	350.5
164.0	161.2*	337.3	-	-	-	-	346.1
177.2	142.6*	330.7	336.2	-	-	-	343.9
190.3	126.5*	321.9	336.2	-	-	-	337.3
203.4	112.7*	292.1	336.2	-	-	-	332.9
216.5	100.5*	265.7	326.3	-	-	-	326.3
229.7	89.9*	242.5	295.4	-	-	-	321.9
242.8	80.5*	222.7	269.0	299.8	-	-	308.6
255.9	71.9*	205.5	245.8	296.5	-	-	291.0
269.0	64.2*	189.4	226.0	270.1	-	-	273.4
282.2	57.1*	174.6	208.1	246.9	-	-	246.9
295.3	-	-	192.0	227.1	-	-	222.7
308.4	-	-	177.0	209.0	204.1	-	205.0
321.5	-	-	-	192.7	193.1	-	190.7
334.6	-	-	-	178.1	183.0	-	170.9
347.8	-	-	-	-	173.5	-	152.1
360.9	-	-	-	-	164.5	134.3	134.5
374.0	-	-	-	-	-	126.5	117.9
387.1	-	-	-	-	-	119.3	101.6
400.3	-	-	-	-	-	-	84.7
413.4	-	-	-	-	-	-	67.2

157.5 ft + 354.3 ft

ft	SWSL						SFSL
	0 lb	176,400 lb – 992,100 lb					
	87°/85°	87°/85°	75°	65°	55°	45°	15°
	1,000 lb						
105.0	196.2*	207.7*	-	-	-	-	-
111.5	196.2*	206.8*	-	-	-	-	-
124.7	194.7	205.0	-	-	-	-	-
137.8	186.1*	201.9	-	-	-	-	199.5
150.9	166.2*	198.9	-	-	-	-	197.3
164.0	149.3*	195.8	-	-	-	-	196.2
177.2	133.4*	192.5	-	-	-	-	194.0
190.3	117.1*	189.2	-	-	-	-	190.7
203.4	103.2*	185.6	-	-	-	-	188.5
216.5	90.8*	182.3	181.2	-	-	-	185.2
229.7	80.0*	179.0	180.1	-	-	-	181.9
242.8	70.5*	175.7	179.0	-	-	-	178.6
255.9	61.9*	172.0	177.7	-	-	-	174.2
269.0	54.2*	166.9	176.4	-	-	-	170.9
282.2	47.2*	160.5	174.8	-	-	-	167.6
295.3	40.8*	153.9	173.5	155.6	-	-	164.2
308.4	35.1*	144.6	171.5	155.6	-	-	160.9
321.5	29.8*	133.6	158.3	155.6	-	-	157.6
334.6	24.9*	123.7	146.4	155.6	-	-	153.2
347.8	20.3*	114.4	135.4	155.6	-	-	148.8
360.9	12.6	105.6	125.4	147.0	135.8	-	144.4
374.0	-	-	116.0	136.0	135.8	-	138.9
387.1	-	-	107.1	125.9	134.5	-	127.9
400.3	-	-	-	116.6	126.8	-	114.6
413.4	-	-	-	107.8	119.5	-	101.4
426.5	-	-	-	-	112.9	90.4	88.6
439.6	-	-	-	-	106.5	85.3	76.1
452.8	-	-	-	-	-	80.7	63.7
465.9	-	-	-	-	-	-	51.6
479.0	-	-	-	-	-	-	39.0

157.5 ft + 315.0 ft

ft	SWSL						SFSL
	0 lb	176,400 lb – 992,100 lb					
	87°/85°	87°/85°	75°	65°	55°	45°	15°
	1,000 lb						
98.4	259.0*	272.3*	-	-	-	-	-
111.5	251.3*	270.1	-	-	-	-	-
124.7	222.7*	266.8	-	-	-	-	262.4
137.8	198.4*	262.4	-	-	-	-	260.1
150.9	177.7*	257.9	-	-	-	-	257.9
164.0	156.3*	253.5	-	-	-	-	257.9
177.2	137.6*	248.0	-	-	-	-	253.5
190.3	121.5*	242.5	243.6	-	-	-	249.1
203.4	107.6*	238.1	242.5	-	-	-	246.9
216.5	95.5*	232.6	241.4	-	-	-	240.3
229.7	84.7*	227.1	239.2	-	-	-	235.9
242.8	75.2*	220.5	237.0	-	-	-	231.5
255.9	66.8*	202.6	233.7	-	-	-	227.1
269.0	59.1*	186.7	222.7	212.7	-	-	222.7
282.2	52.0*	172.2	205.3	212.7	-	-	219.4
295.3	45.9*	159.2	188.9	212.7	-	-	215.0
308.4	39.9*	147.3	174.4	205.7	-	-	209.4
321.5	34.6*	136.0	161.4	189.6	-	-	192.9
334.6	-	-	149.3	175.3	177.7	-	178.6
347.8	-	-	138.0	162.0	167.3	-	165.3
360.9	-	-	-	149.9	157.6	-	148.8
374.0	-	-	-	138.9	148.8	-	132.3
387.1	-	-	-	-	140.7	112.9	116.8
400.3	-	-	-	-	132.9	106.9	103.0
413.4	-	-	-	-	-	101.4	88.6
426.5	-	-	-	-	-	96.1	74.5
439.6	-	-	-	-	-	-	60.2

177.2 ft + 118.1 ft

ft	SWSL						SFSL
	0 lb	176,400 lb – 992,100 lb					
	87°/85°	87°/85°	75°	65°	55°	45°	15°
	1,000 lb						
52.5	681.2*	992.1*	-	-	-	-	-
59.1	610.7*	967.8*	-	-	-	-	-
62.3	582.0*	1020.7	-	-	-	-	956.8
65.6	553.4*	1009.7	-	-	-	-	956.8
72.2	507.1*	987.7	-	-	-	-	956.8
78.7	465.2*	963.4	-	-	-	-	956.8
85.3	427.7*	937.0	-	-	-	-	956.8
91.9	389.1*	884.1	-	-	-	-	948.0
98.4	356.0*	800.3	-	-	-	-	939.2
111.5	303.1*	668.0	868.6	-	-	-	857.6
124.7	261.2*	573.2	771.6	-	-	-	751.8
131.2	243.6*	533.5	727.5	-	-	-	709.9
137.8	220.2	498.2	687.8	-	-	-	668.0
150.9	-	-	604.1	-	-	-	597.5
157.5	-	-	560.0	571.0	-	-	567.7
164.0	-	-	522.5	544.5	-	-	537.9
177.2	-	-	-	498.2	-	-	487.2
190.3	-	-	-	458.6	-	-	445.3
203.4	-	-	-	-	391.3	-	392.4
216.5	-	-	-	-	362.7	-	346.1
229.7	-	-	-	-	-	-	304.2
242.8	-	-	-	-	-	-	280.0
255.9	-	-	-	-	-	-	242.5
269.0	-	-	-	-	-	-	206.1

* Main boom angle 87° · For explanations see page 89

Operation

SWSL, SFSL

374,800–551,200 lb + 0–176,400 lb 49.2–78.7 ft 31.5 ft 32.2 ft/s 360° ASME B30.5

177.2 ft + 157.5 ft

ft	SWSL						SFSL
	0 lb	176,400 lb – 992,100 lb					
	87°/85°	87°/85°	75°	65°	55°	45°	15°
	1,000 lb						
59.1	573.2*	760.6*	-	-	-	-	-
65.6	520.3*	756.2*	-	-	-	-	-
72.2	476.2*	776.0	-	-	-	-	-
78.7	438.7*	773.8	-	-	-	-	740.8
85.3	405.7*	767.2	-	-	-	-	740.8
91.9	377.0*	754.0	-	-	-	-	740.8
98.4	351.6*	738.5	-	-	-	-	740.8
111.5	297.6*	707.7	-	-	-	-	734.1
124.7	256.8*	612.9	-	-	-	-	727.5
131.2	239.2*	568.8	723.1	-	-	-	700.0
137.8	223.8*	531.3	683.4	-	-	-	672.4
150.9	197.3*	467.4	615.1	-	-	-	601.9
164.0	175.0*	414.5	560.0	-	-	-	542.3
177.2	149.5	367.1	489.4	-	-	-	491.6
190.3	-	-	434.3	451.9	-	-	447.5
203.4	-	-	386.9	418.9	-	-	410.1
216.5	-	-	-	389.1	-	-	374.8
229.7	-	-	-	363.8	327.4	-	332.9
242.8	-	-	-	-	305.3	-	297.6
255.9	-	-	-	-	286.6	-	262.4
269.0	-	-	-	-	-	239.2	242.5
282.2	-	-	-	-	-	224.9	215.0
295.3	-	-	-	-	-	-	186.3
308.4	-	-	-	-	-	-	165.3

177.2 ft + 236.2 ft

ft	SWSL						SFSL
	0 lb	176,400 lb – 992,100 lb					
	87°/85°	87°/85°	75°	65°	55°	45°	15°
	1,000 lb						
78.7	388.0*	449.7*	-	-	-	-	-
85.3	359.4*	447.5*	-	-	-	-	-
91.9	334.0*	454.2	-	-	-	-	-
98.4	312.0*	451.9	-	-	-	-	-
111.5	273.4*	445.3	-	-	-	-	440.9
124.7	242.5*	438.7	-	-	-	-	440.9
137.8	212.3*	429.9	-	-	-	-	440.9
150.9	186.1*	420.0	-	-	-	-	440.9
164.0	164.0*	410.1	433.2	-	-	-	440.9
177.2	145.5*	369.3	432.1	-	-	-	427.7
190.3	129.6*	332.9	428.8	-	-	-	416.7
203.4	116.0*	302.0	384.7	-	-	-	405.7
216.5	103.8*	274.5	346.1	-	-	-	383.6
229.7	93.3*	251.3	313.1	349.4	-	-	352.7
242.8	83.6*	230.4	285.5	327.4	-	-	326.3
255.9	-	-	260.1	306.4	-	-	302.0
269.0	-	-	238.1	288.8	-	-	273.4
282.2	-	-	219.1	267.9	235.9	-	246.9
295.3	-	-	-	244.7	221.6	-	220.5
308.4	-	-	-	224.9	209.0	-	198.4
321.5	-	-	-	-	197.1	-	184.1
334.6	-	-	-	-	185.8	161.2	166.4
347.8	-	-	-	-	-	151.9	146.6
360.9	-	-	-	-	-	143.3	127.9
374.0	-	-	-	-	-	-	113.5
387.1	-	-	-	-	-	-	99.2

177.2 ft + 196.9 ft

ft	SWSL						SFSL
	0 lb	176,400 lb – 992,100 lb					
	87°/85°	87°/85°	75°	65°	55°	45°	15°
	1,000 lb						
72.2	447.5*	584.2*	-	-	-	-	-
78.7	413.4*	582.0*	-	-	-	-	-
85.3	382.5*	595.2	-	-	-	-	-
91.9	356.0*	593.0	-	-	-	-	577.6
98.4	331.8*	590.8	-	-	-	-	577.6
111.5	292.1*	577.6	-	-	-	-	577.6
124.7	259.0*	560.0	-	-	-	-	577.6
137.8	226.0*	540.1	-	-	-	-	573.2
144.4	211.4*	504.9	584.2	-	-	-	567.7
150.9	198.2*	474.0	579.8	-	-	-	566.6
164.0	175.5*	422.2	564.4	-	-	-	546.7
177.2	156.1*	377.0	498.2	-	-	-	500.4
190.3	139.6*	340.6	440.9	-	-	-	456.4
203.4	125.2*	307.5	393.5	420.0	-	-	416.7
216.5	-	-	353.8	390.2	-	-	383.6
229.7	-	-	320.8	362.7	-	-	352.7
242.8	-	-	291.0	339.5	-	-	324.1
255.9	-	-	-	318.6	283.3	-	291.0
269.0	-	-	-	299.8	265.7	-	262.4
282.2	-	-	-	-	249.1	-	233.7
295.3	-	-	-	-	233.7	-	213.8
308.4	-	-	-	-	-	194.9	194.0
321.5	-	-	-	-	-	183.6	169.8
334.6	-	-	-	-	-	-	146.6
347.8	-	-	-	-	-	-	134.5

177.2 ft + 275.6 ft

ft	SWSL						SFSL
	0 lb	176,400 lb – 992,100 lb					
	87°/85°	87°/85°	75°	65°	55°	45°	15°
	1,000 lb						
85.3	330.7*	346.1*	-	-	-	-	-
91.9	315.3*	345.0*	-	-	-	-	-
98.4	294.3*	341.7*	-	-	-	-	-
105.0	276.1*	345.0	-	-	-	-	-
124.7	229.3*	339.5	-	-	-	-	335.1
137.8	205.0*	334.0	-	-	-	-	335.1
150.9	181.7*	329.6	-	-	-	-	335.1
164.0	159.6*	323.0	-	-	-	-	332.9
177.2	141.1*	317.5	323.0	-	-	-	330.7
190.3	125.0*	312.0	323.0	-	-	-	326.3
203.4	111.3*	299.8	323.0	-	-	-	321.9
216.5	99.2*	273.4	321.9	-	-	-	315.3
229.7	88.6*	250.2	312.0	-	-	-	310.9
242.8	79.1*	229.3	283.3	-	-	-	306.4
255.9	70.8*	211.0	259.0	287.7	-	-	299.8
269.0	63.1*	194.4	237.0	283.3	-	-	282.2
282.2	56.2*	179.5	218.5	265.7	-	-	260.1
295.3	-	-	201.3	243.6	-	-	235.9
308.4	-	-	185.8	223.8	-	-	213.8
321.5	-	-	171.3	206.4	190.3	-	192.9
334.6	-	-	-	190.5	179.2	-	173.1
347.8	-	-	-	175.9	169.1	-	159.8
360.9	-	-	-	-	159.6	-	145.5
374.0	-	-	-	-	151.0	128.3	129.0
387.1	-	-	-	-	-	121.0	112.4
400.3	-	-	-	-	-	114.2	98.1
413.4	-	-	-	-	-	-	89.7
426.5	-	-	-	-	-	-	73.6

* Main boom angle 87°

Main boom angle 87°, 85°, 75°, 65°, 55° and 45°, capacities for intermediate boom positions are calculated by the crane control system IC-1

0 lb 176,400 lb 352,800 lb 529,200 lb 705,600 lb 882,000 lb 992,100 lb

Operation

SWSL, SFSL

374,800 – 551,200 lb + 0 – 176,400 lb 49.2–78.7 ft 31.5 ft 32.2 ft/s 360° ASME B30.5																						
177.2 ft + 315.0 ft						177.2 ft + 354.3 ft																
SWSL			SFSL			SWSL			SFSL													
0 lb			176,400 lb – 992,100 lb			0 lb			176,400 lb – 992,100 lb													
87°/85°		87°/85°		75°		65°		55°		45°		15°										
ft												1,000 lb										
98.4	248.0*	261.2*	-	-	-	-	-	-	-	-	-	-	105.0	188.9*	199.1*	-	-	-	-	-	-	-
111.5	243.6*	257.9	-	-	-	-	-	-	-	-	-	-	111.5	188.9*	198.2*	-	-	-	-	-	-	-
124.7	215.8*	255.7	-	-	-	-	-	-	-	-	251.3	-	124.7	187.2*	196.2	-	-	-	-	-	-	-
137.8	192.2*	252.4	-	-	-	-	-	-	-	-	249.1	-	137.8	180.1*	194.0	-	-	-	-	-	-	190.7
150.9	172.4*	248.0	-	-	-	-	-	-	-	-	249.1	-	150.9	160.9*	191.4	-	-	-	-	-	-	189.6
164.0	154.8*	243.6	-	-	-	-	-	-	-	-	246.9	-	164.0	144.2*	188.5	-	-	-	-	-	-	188.5
177.2	136.0*	239.2	-	-	-	-	-	-	-	-	244.7	-	177.2	129.9*	185.6	-	-	-	-	-	-	187.4
190.3	120.2*	234.8	-	-	-	-	-	-	-	-	242.5	-	190.3	115.7*	182.5	-	-	-	-	-	-	184.1
203.4	106.3*	229.3	233.7	-	-	-	-	-	-	-	238.1	-	203.4	101.9*	179.2	-	-	-	-	-	-	181.9
216.5	94.1*	224.9	233.7	-	-	-	-	-	-	-	235.9	-	216.5	89.5*	176.1	174.4	-	-	-	-	-	179.7
229.7	83.6*	220.2	232.6	-	-	-	-	-	-	-	231.5	-	229.7	78.9*	172.8	173.9	-	-	-	-	-	176.4
242.8	74.1*	213.8	230.4	-	-	-	-	-	-	-	227.1	-	242.8	69.2*	169.8	173.3	-	-	-	-	-	173.1
255.9	65.5*	205.5	228.2	-	-	-	-	-	-	-	222.7	-	255.9	60.8*	166.4	172.4	-	-	-	-	-	169.8
269.0	58.0*	192.0	226.0	-	-	-	-	-	-	-	218.3	-	269.0	53.1*	161.6	171.3	-	-	-	-	-	166.4
282.2	51.1*	177.3	215.6	204.6	-	-	-	-	-	-	213.8	-	282.2	46.3*	155.0	170.2	-	-	-	-	-	163.1
295.3	44.8*	163.8	198.6	204.6	-	-	-	-	-	-	210.5	-	295.3	39.9*	148.4	169.1	149.3	-	-	-	-	159.8
308.4	39.0*	151.5	183.2	204.6	-	-	-	-	-	-	206.1	-	308.4	34.2*	141.8	167.6	149.3	-	-	-	-	156.5
321.5	33.7*	140.0	169.3	203.3	-	-	-	-	-	-	201.7	-	321.5	28.9*	135.1	165.6	149.3	-	-	-	-	154.3
334.6	-	-	156.7	187.6	-	-	-	-	-	-	184.1	-	334.6	24.0*	127.4	153.9	149.3	-	-	-	-	149.9
347.8	-	-	145.1	173.3	162.3	-	-	-	-	-	166.4	-	347.8	19.4*	117.9	142.4	149.3	-	-	-	-	147.7
360.9	-	-	-	160.5	153.2	-	-	-	-	-	149.9	-	360.9	15.2*	108.9	131.8	149.3	-	-	-	-	142.2
374.0	-	-	-	148.6	145.3	-	-	-	-	-	137.8	-	374.0	-	-	122.1	145.7	130.1	-	-	-	137.8
387.1	-	-	-	137.6	138.0	-	-	-	-	-	126.8	-	387.1	-	-	112.9	135.1	130.1	-	-	-	129.0
400.3	-	-	-	-	131.2	106.7	-	-	-	-	112.4	-	400.3	-	-	-	125.0	125.9	-	-	-	117.9
413.4	-	-	-	-	124.8	100.3	98.3	-	-	-	98.3	-	413.4	-	-	-	115.7	119.5	-	-	-	109.6
426.5	-	-	-	-	-	94.4	84.7	-	-	-	84.7	-	426.5	-	-	-	107.1	113.3	-	-	-	96.6
439.6	-	-	-	-	-	88.8	75.2	-	-	-	75.2	-	439.6	-	-	-	-	107.8	82.0	-	-	84.2
452.8	-	-	-	-	-	-	65.0	-	-	-	65.0	-	452.8	-	-	-	-	102.5	76.7	-	-	72.1
465.9	-	-	-	-	-	-	-	-	-	-	50.9	-	465.9	-	-	-	-	-	71.7	-	-	61.7
479.0	-	-	-	-	-	-	-	-	-	-	-	-	479.0	-	-	-	-	-	-	-	-	55.6
492.1	-	-	-	-	-	-	-	-	-	-	-	-	492.1	-	-	-	-	-	-	-	-	43.7
505.3	-	-	-	-	-	-	-	-	-	-	-	-	505.3	-	-	-	-	-	-	-	-	31.3

* Main boom angle 87°

Main boom angle 87°, 85°, 75°, 65°, 55° and 45°, capacities for intermediate boom positions are calculated by the crane control system IC-1

	0 lb	176,400 lb	352,800 lb	529,200 lb	705,600 lb	882,000 lb	992,100 lb
--	------	------------	------------	------------	------------	------------	------------

Operation

SWSL, SFSL

374,800 – 551,200 lb + 0 – 176,400 lb 49.2–78.7 ft 31.5 ft 32.2 ft/s 360° ASME B30.5											
196.9 ft + 118.1 ft						196.9 ft					
SWSL						SFSL					
0 lb						176,400 lb – 992,100 lb					
87°/85° 87°/85° 75° 65° 55° 45° 15°						87°/85° 87°/85° 75° 65° 55° 45° 15°					
ft						ft					
1,000 lb						1,000 lb					
52.5	654.8*	908.3*	-	-	-	72.2	433.2*	546.7*	-	-	-
59.1	588.6*	886.3*	-	-	-	78.7	400.1*	544.5*	-	-	-
62.3	562.2*	941.4	-	-	-	85.3	370.4*	560.0	-	-	-
65.6	535.7*	941.4	-	-	-	91.9	345.0*	560.0	-	-	537.9
72.2	489.4*	923.7	-	-	-	98.4	321.9*	560.0	-	-	537.9
78.7	449.7*	903.9	-	-	-	111.5	284.4*	551.2	-	-	537.9
85.3	417.8*	881.8	-	-	-	124.7	252.4*	535.7	-	-	537.9
91.9	385.8*	844.4	-	-	-	137.8	223.8*	520.3	-	-	537.9
98.4	352.7*	815.7	-	-	-	150.9	196.2*	487.2	551.2	-	533.5
111.5	299.8*	681.2	-	-	-	164.0	173.5*	432.1	546.7	-	515.9
118.1	277.8*	628.3	806.9	-	-	177.2	154.3*	386.9	509.3	-	493.8
124.7	259.0*	582.0	762.8	-	-	190.3	137.8*	348.3	465.2	-	449.7
131.2	241.4*	542.3	718.7	-	-	203.4	123.7*	315.3	415.6	-	410.1
137.8	216.5	507.1	681.2	-	-	216.5	104.3	282.2	372.6	381.4	377.0
150.9	-	-	612.9	-	-	229.7	-	-	336.2	354.9	346.1
164.0	-	-	551.2	-	-	242.8	-	-	305.3	331.8	319.7
173.9	-	-	-	498.2	-	255.9	-	-	-	312.0	295.4
177.2	-	-	-	487.2	-	269.0	-	-	-	293.2	271.2
190.3	-	-	-	449.7	-	282.2	-	-	-	275.6	242.5
203.4	-	-	-	416.7	-	295.3	-	-	-	-	218.3
216.5	-	-	-	-	362.7	308.4	-	-	-	220.5	194.0
229.7	-	-	-	-	338.4	321.5	-	-	-	-	177.5
242.8	-	-	-	-	-	334.6	-	-	-	180.6	158.7
255.9	-	-	-	-	-	347.8	-	-	-	-	137.8
269.0	-	-	-	-	-	360.9	-	-	-	-	116.8
282.2	-	-	-	-	-	-	-	-	-	-	-
295.3	-	-	-	-	-	-	-	-	-	-	-

196.9 ft + 157.5 ft					
ft					
1,000 lb					
62.3	526.9*	705.5*	-	-	-
65.6	502.7*	701.1*	-	-	-
72.2	460.8*	729.7	-	-	-
78.7	424.4*	725.3	-	-	683.4
85.3	393.5*	720.9	-	-	683.4
91.9	366.0*	712.1	-	-	683.4
98.4	341.7*	698.9	-	-	683.4
111.5	294.3*	670.2	-	-	683.4
124.7	253.5*	623.9	-	-	676.8
134.5	229.3*	561.1	694.5	-	666.9
137.8	221.6*	542.3	674.6	-	665.8
150.9	195.1*	478.4	608.5	-	595.2
164.0	172.8*	424.4	551.2	-	535.7
177.2	146.2	378.1	504.9	-	485.0
190.3	-	-	456.4	443.1	440.9
203.4	-	-	407.9	410.1	403.4
216.5	-	-	-	381.4	368.2
229.7	-	-	-	354.9	339.5
242.8	-	-	-	332.9	305.3
255.9	-	-	-	-	286.6
269.0	-	-	-	-	269.0
282.2	-	-	-	-	217.8
295.3	-	-	-	-	205.9
308.4	-	-	-	-	175.3
321.5	-	-	-	-	149.9

196.9 ft + 236.2 ft					
ft					
1,000 lb					
78.7	374.8*	425.5*	-	-	-
85.3	347.2*	423.3*	-	-	-
91.9	323.0*	431.0	-	-	-
98.4	302.0*	431.0	-	-	-
111.5	265.7*	426.6	-	-	414.5
124.7	235.9*	420.0	-	-	414.5
137.8	210.3*	412.3	-	-	414.5
150.9	184.1*	403.4	-	-	414.5
164.0	162.3*	394.6	-	-	414.5
177.2	144.0*	378.1	410.1	-	410.1
190.3	128.1*	340.6	409.0	-	396.8
203.4	114.4*	308.6	406.8	-	385.8
216.5	102.3*	281.1	364.9	-	377.0
229.7	91.7*	256.8	329.6	-	346.1
242.8	82.2*	234.8	298.7	319.7	319.7
255.9	-	-	272.3	299.8	295.4
269.0	-	-	249.1	281.1	273.4
282.2	-	-	228.2	265.7	253.5
295.3	-	-	-	250.2	221.6
308.4	-	-	-	237.0	208.8
321.5	-	-	-	220.5	196.7
334.6	-	-	-	-	185.6
347.8	-	-	-	-	175.5
360.9	-	-	-	-	149.9
374.0	-	-	-	-	133.4
387.1	-	-	-	-	101.9
400.3	-	-	-	-	89.5

* Main boom angle 87°
For explanations see page 90

	0 lb	176,400 lb	352,800 lb	529,200 lb	705,600 lb	882,000 lb	992,100 lb
--	------	------------	------------	------------	------------	------------	------------

Operation

SWSL, SFSL

374,800 – 551,200 lb + 0 – 176,400 lb 49.2–78.7 ft 31.5 ft 32.2 ft/s 360° ASME B30.5										
196.9 ft + 275.6 ft						196.9 ft + 315.0 ft				
SWSL			SFSL			SWSL			SFSL	
0 lb		176,400 lb – 992,100 lb				0 lb		176,400 lb – 992,100 lb		
87°/85°		87°/85°		75°		65°		55°		45° 15°
1,000 lb										
91.9	305.3*	327.4*	-	-	-	-	-	-	-	-
98.4	285.5*	325.2*	-	-	-	-	-	-	-	-
105.0	267.9*	328.5	-	-	-	-	-	-	-	-
111.5	250.2*	328.5	-	-	-	-	-	-	-	-
124.7	221.6*	325.2	-	-	-	-	-	-	-	317.5
137.8	198.6*	320.8	-	-	-	-	-	-	-	317.5
150.9	178.6*	316.4	-	-	-	-	-	-	-	317.5
164.0	157.9*	310.9	-	-	-	-	-	-	-	317.5
177.2	139.3*	305.3	-	-	-	-	-	-	-	317.5
190.3	123.5*	300.9	308.6	-	-	-	-	-	-	315.3
203.4	109.8*	295.4	307.5	-	-	-	-	-	-	308.6
216.5	97.9*	280.0	307.5	-	-	-	-	-	-	304.2
229.7	87.3*	255.7	306.4	-	-	-	-	-	-	297.6
242.8	77.8*	234.8	297.6	-	-	-	-	-	-	293.2
255.9	69.4*	215.8	271.2	273.4	-	-	-	-	-	288.8
269.0	61.9*	198.9	248.0	273.4	-	-	-	-	-	275.6
282.2	54.9*	183.4	228.2	260.1	-	-	-	-	-	255.7
295.3	-	-	210.3	245.8	-	-	-	-	-	235.9
308.4	-	-	194.0	232.6	-	-	-	-	-	219.4
321.5	-	-	179.0	219.8	189.6	-	-	-	-	199.5
334.6	-	-	-	202.8	178.6	-	-	-	-	179.7
347.8	-	-	-	187.2	168.7	-	-	-	-	160.9
360.9	-	-	-	-	159.2	-	-	-	-	143.3
374.0	-	-	-	-	150.6	-	-	-	-	131.2
387.1	-	-	-	-	142.4	118.8	-	-	-	120.2
400.3	-	-	-	-	-	112.0	-	-	-	104.9
413.4	-	-	-	-	-	-	89.9	-	-	89.9
426.5	-	-	-	-	-	-	-	75.4	-	75.4
439.6	-	-	-	-	-	-	-	-	67.9	67.9
98.4	237.0*	248.0*	-	-	-	-	-	-	-	-
111.5	233.7*	244.7*	-	-	-	-	-	-	-	-
118.1	221.2*	246.9	-	-	-	-	-	-	-	-
124.7	208.8*	245.8	-	-	-	-	-	-	-	-
137.8	186.1*	242.5	-	-	-	-	-	-	-	238.1
150.9	166.7*	239.2	-	-	-	-	-	-	-	238.1
164.0	149.9*	234.8	-	-	-	-	-	-	-	238.1
177.2	134.5*	231.5	-	-	-	-	-	-	-	235.9
190.3	118.6*	227.1	-	-	-	-	-	-	-	233.7
203.4	104.7*	222.7	223.8	-	-	-	-	-	-	231.5
216.5	92.8*	218.3	223.8	-	-	-	-	-	-	227.1
229.7	82.2*	213.8	223.8	-	-	-	-	-	-	222.7
242.8	72.8*	208.6	223.8	-	-	-	-	-	-	220.5
255.9	64.4*	201.7	221.6	-	-	-	-	-	-	216.1
269.0	56.9*	194.7	219.8	-	-	-	-	-	-	212.7
282.2	49.8*	181.2	217.2	195.6	-	-	-	-	-	208.3
295.3	43.7*	167.6	207.5	195.6	-	-	-	-	-	205.0
308.4	37.9*	155.0	191.4	195.6	-	-	-	-	-	200.6
321.5	32.6*	143.3	176.8	195.6	-	-	-	-	-	196.2
334.6	-	-	163.6	195.6	-	-	-	-	-	189.6
347.8	-	-	151.5	184.5	-	-	-	-	-	172.0
360.9	-	-	140.0	170.9	152.1	-	-	-	-	155.4
374.0	-	-	-	158.1	143.5	-	-	-	-	138.9
387.1	-	-	-	146.4	135.4	-	-	-	-	123.5
400.3	-	-	-	-	127.9	-	-	-	-	112.4
413.4	-	-	-	-	120.8	98.1	-	-	-	103.6
426.5	-	-	-	-	114.2	92.2	-	-	-	90.6
439.6	-	-	-	-	-	86.6	-	-	-	77.4
452.8	-	-	-	-	-	81.6	-	-	-	64.6
465.9	-	-	-	-	-	-	-	-	-	56.9
479.0	-	-	-	-	-	-	-	-	-	45.9

* Main boom angle 87°

Main boom angle 87°, 85°, 75°, 65°, 55° and 45°, capacities for intermediate boom positions are calculated by the crane control system IC-1

	0 lb	176,400 lb	352,800 lb	529,200 lb	705,600 lb	882,000 lb	992,100 lb
---	------	------------	------------	------------	------------	------------	------------

Operation

SWSL, SFSL

374,800 – 551,200 lb + 0 – 176,400 lb 49.2 – 78.7 ft 31.5 ft 32.2 ft/s 360° ASME B30.5

196.9 ft + 354.3 ft

ft	SWSL					SFSL
	0 lb	176,400 lb – 992,100 lb				
	87°/85°	87°/85°	75°	65°	55°	45°
	1,000 lb					
105.0	175.9*	186.1*	-	-	-	-
111.5	175.9*	185.4*	-	-	-	-
124.7	174.8	183.4	-	-	-	-
137.8	171.1*	181.7	-	-	-	-
150.9	155.4*	179.0	-	-	-	177.5
164.0	139.3*	176.4	-	-	-	176.4
177.2	125.2*	173.7	-	-	-	175.3
190.3	112.9*	170.9	-	-	-	173.1
203.4	100.3*	167.8	-	-	-	170.9
216.5	88.2*	164.7	161.8	-	-	167.6
229.7	77.6*	161.8	161.6	-	-	165.3
242.8	68.1*	158.7	161.2	-	-	162.0
255.9	59.5*	155.9	160.7	-	-	159.8
269.0	52.0*	151.5	160.1	-	-	156.5
282.2	45.2*	145.5	159.0	-	-	153.2
295.3	38.8*	139.1	157.6	-	-	151.0
308.4	33.1*	132.9	156.5	138.0	-	147.7
321.5	27.8*	126.5	154.8	138.0	-	144.4
334.6	22.9*	120.2	151.9	138.0	-	141.1
347.8	18.5*	114.0	147.5	138.0	-	138.9
360.9	14.3*	107.6	137.8	138.0	-	135.6
374.0	-	-	127.6	138.0	-	130.1
387.1	-	-	118.2	138.0	119.9	124.6
400.3	-	-	109.1	133.4	119.7	119.0
413.4	-	-	-	123.5	114.4	106.5
426.5	-	-	-	114.4	107.8	95.7
439.6	-	-	-	-	101.6	87.7
452.8	-	-	-	-	95.7	74.5
465.9	-	-	-	-	90.6	69.4
479.0	-	-	-	-	-	64.8
492.1	-	-	-	-	-	60.4
518.4	-	-	-	-	-	26.7

* Main boom angle 87°

Main boom angle 87°, 85°, 75°, 65°, 55° and 45°, capacities for intermediate boom positions are calculated by the crane control system IC-1

	0 lb	176,400 lb	352,800 lb	529,200 lb
	705,600 lb	882,000 lb	992,100 lb	

216.5 ft + 118.1 ft

ft	SWSL					SFSL
	0 lb	176,400 lb – 992,100 lb				
	87°/85°	87°/85°	75°	65°	55°	45°
	1,000 lb					
52.5	630.5*	835.6*	-	-	-	-
59.1	568.8*	824.5*	-	-	-	-
65.6	515.9*	857.6	-	-	-	811.3
72.2	474.0*	848.8	-	-	-	811.3
78.7	436.5*	833.3	-	-	-	811.3
85.3	404.5*	813.5	-	-	-	811.3
91.9	377.0*	793.7	-	-	-	800.3
98.4	350.5*	773.8	-	-	-	800.3
111.5	297.6*	696.7	-	-	-	784.8
124.7	256.8*	593.0	751.8	-	-	738.5
131.2	239.2*	551.2	712.1	-	-	696.7
137.8	213.0	513.7	672.4	-	-	654.8
150.9	-	-	606.3	-	-	584.2
164.0	-	-	551.2	-	-	524.7
177.2	-	-	504.9	478.4	-	474.0
190.3	-	-	-	440.9	-	429.9
203.4	-	-	-	407.9	-	392.4
216.5	-	-	-	-	-	357.1
229.7	-	-	-	-	332.9	328.5
242.8	-	-	-	-	312.0	295.4
255.9	-	-	-	-	-	260.1
269.0	-	-	-	-	-	229.3
282.2	-	-	-	-	-	208.3
295.3	-	-	-	-	-	181.9
308.4	-	-	-	-	-	153.2

216.5 ft + 157.5 ft

ft	SWSL					SFSL
	0 lb	176,400 lb – 992,100 lb				
	87°/85°	87°/85°	75°	65°	55°	45°
	1,000 lb					
62.3	507.1*	654.8*	-	-	-	-
65.6	485.0*	654.8*	-	-	-	-
72.2	445.3*	646.0*	-	-	-	-
78.7	411.2*	672.4	-	-	-	639.3
85.3	381.4*	668.0	-	-	-	639.3
91.9	354.9*	659.2	-	-	-	639.3
98.4	331.8*	648.2	-	-	-	639.3
111.5	292.1*	623.9	-	-	-	639.3
124.7	251.3*	599.7	-	-	-	623.9
137.8	219.4*	551.2	665.8	-	-	617.3
150.9	192.9*	485.0	601.9	-	-	590.8
164.0	170.9*	432.1	546.7	-	-	529.1
177.2	143.3	381.4	498.2	-	-	478.4
190.3	-	-	458.6	-	-	434.3
203.4	-	-	425.5	401.2	-	396.8
216.5	-	-	383.6	372.6	-	361.6
229.7	-	-	-	347.2	-	332.9
242.8	-	-	-	325.2	-	306.4
255.9	-	-	-	-	283.3	282.2
269.0	-	-	-	-	265.7	253.5
282.2	-	-	-	-	250.2	227.1
295.3	-	-	-	-	-	196.0
308.4	-	-	-	-	-	185.4
321.5	-	-	-	-	-	163.1
334.6	-	-	-	-	-	140.0
347.8	-	-	-	-	-	116.8

Operation

SWSL, SFSL

374,800 – 551,200 lb + 0 – 176,400 lb 49.2–78.7 ft 31.5 ft 32.2 ft/s 360° ASME B30.5										
216.5 ft + 196.9 ft						216.5 ft + 236.2 ft				
SWSL			SFSL			SWSL			SFSL	
0 lb		176,400 lb – 992,100 lb				0 lb		176,400 lb – 992,100 lb		
87°/85°		87°/85°		75°		65°		55°		45° 15°
ft 1,000 lb										
72.2	418.9*	513.7*	-	-	-	-	-	-	-	-
78.7	386.9*	511.5*	-	-	-	-	-	-	-	-
85.3	359.4*	524.7	-	-	-	-	-	-	-	-
91.9	334.0*	524.7	-	-	-	-	-	-	504.9	-
98.4	312.0*	522.5	-	-	-	-	-	-	504.9	-
111.5	275.6*	515.9	-	-	-	-	-	-	504.9	-
124.7	244.7*	502.7	-	-	-	-	-	-	504.9	-
137.8	220.5*	487.2	-	-	-	-	-	-	498.2	-
150.9	194.4*	471.8	-	-	-	-	-	-	493.8	-
157.5	182.5*	463.0	518.1	-	-	-	-	-	491.6	-
164.0	171.7*	445.3	513.7	-	-	-	-	-	489.4	-
177.2	152.8*	411.2	502.7	-	-	-	-	-	469.6	-
190.3	136.2*	371.5	463.0	-	-	-	-	-	443.1	-
203.4	122.1*	330.7	427.7	-	-	-	-	-	405.7	-
216.5	102.1	280.0	396.8	-	-	-	-	-	370.4	-
229.7	-	-	367.1	347.2	-	-	-	-	339.5	-
242.8	-	-	335.1	325.2	-	-	-	-	313.1	-
255.9	-	-	294.3	304.2	-	-	-	-	288.8	-
269.0	-	-	-	286.6	-	-	-	-	266.8	-
282.2	-	-	-	270.1	246.9	-	-	-	246.9	-
295.3	-	-	-	-	231.5	-	-	-	224.9	-
308.4	-	-	-	-	218.7	-	-	-	201.7	-
321.5	-	-	-	-	206.6	-	-	-	179.7	-
334.6	-	-	-	-	-	162.0	-	-	157.6	-
347.8	-	-	-	-	-	153.9	-	-	145.5	-
360.9	-	-	-	-	-	-	-	-	127.9	-
374.0	-	-	-	-	-	-	-	-	108.7	-
387.1	-	-	-	-	-	-	-	-	92.4	-
78.7	361.6*	402.3*	-	-	-	-	-	-	-	-
85.3	335.1*	401.2*	-	-	-	-	-	-	-	-
91.9	312.0*	397.9*	-	-	-	-	-	-	-	-
98.4	292.1*	406.8	-	-	-	-	-	-	-	-
111.5	256.8*	402.3	-	-	-	-	-	-	392.4	-
124.7	228.2*	396.8	-	-	-	-	-	-	392.4	-
137.8	204.6*	390.2	-	-	-	-	-	-	392.4	-
150.9	182.3*	382.5	-	-	-	-	-	-	392.4	-
164.0	160.7*	373.7	-	-	-	-	-	-	392.4	-
177.2	142.4*	366.0	390.2	-	-	-	-	-	390.2	-
190.3	126.5*	354.9	389.1	-	-	-	-	-	377.0	-
203.4	113.1*	332.9	386.9	-	-	-	-	-	368.2	-
216.5	101.0*	303.1	383.6	-	-	-	-	-	359.4	-
229.7	90.6*	273.4	357.1	-	-	-	-	-	341.7	-
242.8	81.1*	240.3	329.6	312.0	-	-	-	-	315.3	-
255.9	65.9	205.0	300.9	292.1	-	-	-	-	288.8	-
269.0	-	-	275.6	274.5	-	-	-	-	266.8	-
282.2	-	-	252.4	259.0	-	-	-	-	246.9	-
295.3	-	-	-	244.7	-	-	-	-	229.3	-
308.4	-	-	-	231.5	206.1	-	-	-	212.7	-
321.5	-	-	-	219.6	194.2	-	-	-	190.7	-
334.6	-	-	-	-	183.2	-	-	-	170.9	-
347.8	-	-	-	-	173.1	-	-	-	152.1	-
360.9	-	-	-	-	163.6	135.6	-	-	134.5	-
374.0	-	-	-	-	-	128.8	-	-	123.5	-
387.1	-	-	-	-	-	122.6	-	-	110.0	-
400.3	-	-	-	-	-	-	-	-	93.7	-
413.4	-	-	-	-	-	-	-	-	77.2	-
426.5	-	-	-	-	-	-	-	-	67.7	-

* Main boom angle 87°

Main boom angle 87°, 85°, 75°, 65°, 55° and 45°, capacities for intermediate boom positions are calculated by the crane control system IC-1

	0 lb	176,400 lb	352,800 lb	529,200 lb	705,600 lb	882,000 lb	992,100 lb
---	------	------------	------------	------------	------------	------------	------------

Operation

SWSL, SFSL

374,800 – 551,200 lb + 0 – 176,400 lb 49.2–78.7 ft 31.5 ft 32.2 ft/s 360° ASME B30.5										
216.5 ft + 275.6 ft						216.5 ft + 315.0 ft				
SWSL			SFSL			SWSL			SFSL	
0 lb		176,400 lb – 992,100 lb				0 lb		176,400 lb – 992,100 lb		
87°/85°		87°/85°		75°		65°		55°		45° 15°
1,000 lb										
ft	ft	ft	ft	ft	ft	ft	ft	ft	ft	ft
91.9	295.4*	310.9*	-	-	-	-	-	-	-	-
98.4	275.6*	308.6*	-	-	-	-	-	-	-	-
105.0	259.0*	312.0	-	-	-	-	-	-	-	-
111.5	242.5*	312.0	-	-	-	-	-	-	-	-
124.7	215.2*	308.6	-	-	-	-	-	-	302.0	-
137.8	192.2*	305.3	-	-	-	-	-	-	302.0	-
150.9	172.8*	300.9	-	-	-	-	-	-	302.0	-
164.0	156.1*	296.5	-	-	-	-	-	-	302.0	-
177.2	137.8*	291.0	-	-	-	-	-	-	302.0	-
190.3	122.1*	286.6	294.3	-	-	-	-	-	302.0	-
203.4	108.5*	281.1	294.3	-	-	-	-	-	297.6	-
216.5	96.6*	276.7	294.3	-	-	-	-	-	291.0	-
229.7	86.0*	272.3	293.2	-	-	-	-	-	284.4	-
242.8	76.7*	253.5	292.1	-	-	-	-	-	280.0	-
255.9	68.3*	232.6	291.0	-	-	-	-	-	275.6	-
269.0	60.8*	211.2	273.4	261.2	-	-	-	-	269.0	-
282.2	54.0*	186.7	251.3	253.5	-	-	-	-	249.1	-
295.3	-	-	231.5	239.2	-	-	-	-	231.5	-
308.4	-	-	214.5	226.0	-	-	-	-	215.0	-
321.5	-	-	197.8	214.7	-	-	-	-	199.5	-
334.6	-	-	-	203.5	175.9	-	-	-	184.1	-
347.8	-	-	-	193.3	166.0	-	-	-	165.3	-
360.9	-	-	-	183.9	156.7	-	-	-	148.8	-
374.0	-	-	-	-	148.2	-	-	-	132.3	-
387.1	-	-	-	-	140.0	-	-	-	116.8	-
400.3	-	-	-	-	132.5	108.2	-	-	106.0	-
413.4	-	-	-	-	-	102.1	95.9	-	-	-
426.5	-	-	-	-	-	96.3	81.8	-	-	-
439.6	-	-	-	-	-	-	67.9	-	-	-
452.8	-	-	-	-	-	-	56.9	-	-	-
98.4	227.1*	235.9*	-	-	-	-	-	-	-	-
111.5	222.7*	233.7*	-	-	-	-	-	-	-	-
118.1	212.2*	234.8	-	-	-	-	-	-	-	-
124.7	201.7*	234.8	-	-	-	-	-	-	-	-
137.8	179.7*	231.5	-	-	-	-	-	-	229.3	-
150.9	160.9*	228.2	-	-	-	-	-	-	227.1	-
164.0	144.8*	224.9	-	-	-	-	-	-	227.1	-
177.2	131.0*	221.6	-	-	-	-	-	-	227.1	-
190.3	117.1*	217.8	-	-	-	-	-	-	224.9	-
203.4	103.4*	213.6	215.6	-	-	-	-	-	222.7	-
216.5	91.5*	209.7	215.6	-	-	-	-	-	220.5	-
229.7	80.9*	205.5	215.6	-	-	-	-	-	216.1	-
242.8	71.7*	200.8	215.4	-	-	-	-	-	212.7	-
255.9	63.3*	195.6	214.3	-	-	-	-	-	209.4	-
269.0	55.8*	189.8	212.7	-	-	-	-	-	206.1	-
282.2	48.9*	184.1	210.3	-	-	-	-	-	201.7	-
295.3	42.8*	178.6	208.3	187.6	-	-	-	-	198.4	-
308.4	37.0*	164.2	206.1	187.6	-	-	-	-	195.1	-
321.5	31.7*	145.3	196.0	187.4	-	-	-	-	190.7	-
334.6	-	-	181.7	187.4	-	-	-	-	186.3	-
347.8	-	-	168.4	187.4	-	-	-	-	172.0	-
360.9	-	-	155.2	178.8	149.5	-	-	-	157.6	-
374.0	-	-	-	170.0	140.9	-	-	-	142.2	-
387.1	-	-	-	161.8	132.9	-	-	-	127.9	-
400.3	-	-	-	154.1	125.4	-	-	-	113.5	-
413.4	-	-	-	-	118.4	-	-	-	100.3	-
426.5	-	-	-	-	112.0	88.6	-	-	89.7	-
439.6	-	-	-	-	-	83.1	81.8	-	-	-
452.8	-	-	-	-	-	78.0	69.7	-	-	-
465.9	-	-	-	-	-	73.2	57.5	-	-	-
479.0	-	-	-	-	-	-	45.4	-	-	-
492.1	-	-	-	-	-	-	36.8	-	-	-

* Main boom angle 87°

Main boom angle 87°, 85°, 75°, 65°, 55° and 45°, capacities for intermediate boom positions are calculated by the crane control system IC-1

	0 lb	176,400 lb	352,800 lb	529,200 lb	705,600 lb	882,000 lb	992,100 lb
---	------	------------	------------	------------	------------	------------	------------

Operation

SWSL, SFSL

374,800 – 551,200 lb + 0 – 176,400 lb 49.2–78.7 ft 31.5 ft 32.2 ft/s 360° ASME B30.5										
216.5 ft + 354.3 ft						236.2 ft + 118.1 ft				
SWSL						SWSL				
SFSL						SFSL				
0 lb						0 lb				
176,400 lb – 992,100 lb						176,400 lb – 992,100 lb				
87°/85° 87°/85° 75° 65° 55° 45° 15°						87°/85° 87°/85° 75° 65° 55° 45° 15°				
ft						ft				
1,000 lb						1,000 lb				
105.0	169.1*	176.8*	-	-	-	52.5	604.1*	762.8*	-	-
111.5	169.1*	176.8*	-	-	-	59.1	546.7*	756.2*	-	-
124.7	168.0*	174.8	-	-	-	65.6	498.2*	782.6	-	740.8
137.8	164.2*	173.7	-	-	-	72.2	456.4*	778.2	-	740.8
150.9	149.7*	171.7	-	-	-	78.7	422.2*	765.0	-	740.8
164.0	134.0*	169.3	-	-	-	85.3	391.3*	747.4	-	740.8
177.2	120.6*	167.1	-	-	-	91.9	364.9*	729.7	-	740.8
190.3	108.7*	164.5	-	-	-	98.4	341.7*	712.1	-	729.7
203.4	97.9*	161.6	-	-	-	111.5	294.3*	676.8	-	720.9
216.5	87.1*	158.7	-	-	-	124.7	253.5*	604.1	-	714.3
229.7	76.3*	155.9	155.0	-	-	131.2	235.9*	560.0	698.9	680.1
242.8	67.0*	153.2	155.0	-	-	137.8	208.8	522.5	663.6	646.0
255.9	58.6*	150.4	154.8	-	-	144.4	195.1	489.4	630.5	610.7
269.0	50.9*	146.6	154.5	-	-	150.9	-	-	597.5	575.4
282.2	44.1*	141.5	153.9	-	-	164.0	-	-	544.5	515.9
295.3	37.9*	136.0	152.8	-	-	177.2	-	-	498.2	465.2
308.4	32.2*	130.7	151.9	-	-	190.3	-	-	431.0	421.1
321.5	26.9*	125.2	150.4	132.1	-	203.4	-	-	397.9	383.6
334.6	22.3*	119.7	148.6	132.1	-	216.5	-	-	370.4	350.5
347.8	17.6*	114.4	145.5	132.1	-	229.7	-	-	-	319.7
360.9	13.4*	108.9	142.0	132.1	-	242.8	-	-	300.9	293.2
374.0	-	-	138.2	132.1	-	255.9	-	-	282.2	266.8
387.1	-	-	132.7	132.1	-	269.0	-	-	-	235.9
400.3	-	-	121.9	132.1	114.4	282.2	-	-	-	208.3
413.4	-	-	-	132.1	111.8	295.3	-	-	-	183.0
426.5	-	-	-	131.0	105.4	308.4	-	-	-	166.4
439.6	-	-	-	121.7	99.2	321.5	-	-	-	140.0
452.8	-	-	-	-	93.5	-	-	-	-	-
465.9	-	-	-	-	88.0	-	-	-	-	-
479.0	-	-	-	-	-	-	-	-	-	-
492.1	-	-	-	-	-	-	-	-	-	-
505.3	-	-	-	-	-	-	-	-	-	-
518.4	-	-	-	-	-	-	-	-	-	-
531.5	-	-	-	-	-	-	-	-	-	-

* Main boom angle 87°

Main boom angle 87°, 85°, 75°, 65°, 55° and 45°, capacities for intermediate boom positions are calculated by the crane control system IC-1

	0 lb	176,400 lb	352,800 lb	529,200 lb
	705,600 lb	882,000 lb	992,100 lb	

236.2 ft + 157.5 ft										
						1,000 lb				
ft						ft				
62.3	489.4*	604.1*	-	-	-	62.3	489.4*	604.1*	-	-
65.6	467.4*	604.1*	-	-	-	65.6	467.4*	604.1*	-	-
72.2	429.9*	595.2*	-	-	-	72.2	429.9*	595.2*	-	-
78.7	396.8*	619.5	-	-	-	78.7	396.8*	619.5	-	586.4
85.3	368.2*	615.1	-	-	-	85.3	368.2*	615.1	-	586.4
91.9	343.9*	608.5	-	-	-	91.9	343.9*	608.5	-	586.4
98.4	321.9*	597.5	-	-	-	98.4	321.9*	597.5	-	586.4
111.5	284.4*	577.6	-	-	-	111.5	284.4*	577.6	-	586.4
124.7	248.0*	553.4	-	-	-	124.7	248.0*	553.4	-	577.6
137.8	216.7*	531.3	-	-	-	137.8	216.7*	531.3	-	571.0
144.4	202.8*	507.1	615.1	-	-	144.4	202.8*	507.1	615.1	562.2
150.9	190.3*	491.6	593.0	-	-	150.9	190.3*	491.6	593.0	557.8
164.0	168.4*	437.6	537.9	-	-	164.0	168.4*	437.6	537.9	522.5
177.2	139.8	392.4	491.6	-	-	177.2	139.8	392.4	491.6	471.8
190.3	-	-	451.9	-	-	190.3	-	-	451.9	427.7
203.4	-	-	418.9	-	-	203.4	-	-	418.9	390.2
216.5	-	-	389.1	363.8	-	216.5	-	-	389.1	354.9
229.7	-	-	-	338.4	-	229.7	-	-	-	324.1
242.8	-	-	-	317.5	-	242.8	-	-	-	297.6
255.9	-	-	-	297.6	-	255.9	-	-	-	273.4
269.0	-	-	-	-	257.9	269.0	-	-	-	253.5
282.2	-	-	-	-	243.6	282.2	-	-	-	229.3
295.3	-	-	-	-	229.3	295.3	-	-	-	205.0
308.4	-	-	-	-	-	308.4	-	-	-	181.9
321.5	-	-	-	-	-	321.5	-	-	-	158.7
334.6	-	-	-	-	-	334.6	-	-	-	144.4
347.8	-	-	-	-	-	347.8	-	-	-	126.8
360.9	-	-	-	-	-	360.9	-	-	-	105.6

Operation

SWSL, SFSL

374,800 – 551,200 lb + 0 – 176,400 lb 49.2 – 78.7 ft 31.5 ft 32.2 ft/s 360° ASME B30.5												
236.2 ft + 196.9 ft						236.2 ft + 236.2 ft						
SWSL			SFSL			SWSL			SFSL			
0 lb		176,400 lb – 992,100 lb				0 lb		176,400 lb – 992,100 lb				
87°/85°		87°/85°		75°		65°		55°		45° 15°		
1,000 lb						1,000 lb						
72.2	403.4*	478.4*	-	-	-	85.3	324.1*	375.9*	-	-	-	
78.7	373.7*	476.2*	-	-	-	91.9	302.0*	373.7*	-	-	-	
85.3	346.1*	487.2	-	-	-	98.4	282.2*	380.3	-	-	-	
91.9	323.0*	487.2	-	-	-	111.5	248.0*	378.1	-	-	-	
98.4	302.0*	485.0	-	-	-	124.7	220.5*	373.7	-	-	-	
111.5	266.8*	478.4	-	-	-	137.8	198.0*	367.1	-	-	-	
124.7	238.1*	467.4	-	-	-	150.9	178.4*	359.4	-	-	-	
137.8	213.8*	451.9	-	-	-	164.0	158.7*	351.6	-	-	-	
150.9	192.2*	438.7	-	-	-	177.2	140.4*	343.9	368.2	-	-	
164.0	169.8*	424.4	485.0	-	-	190.3	125.0*	336.2	366.0	-	-	
177.2	150.8*	400.1	478.4	-	-	203.4	111.3*	325.2	364.9	-	-	
190.3	134.5*	375.9	456.4	-	-	216.5	99.4*	307.5	362.7	-	-	
203.4	120.4*	338.4	421.1	-	-	229.7	89.1*	278.9	351.6	-	-	
216.5	99.4	288.8	391.3	-	-	242.8	79.6*	245.8	328.5	-	-	
229.7	-	-	363.8	337.3	-	255.9	63.7	211.4	308.6	284.4	-	
242.8	-	-	340.6	315.3	-	269.0	-	-	286.6	266.8	-	
255.9	-	-	315.3	296.5	-	282.2	-	-	262.4	251.3	-	
269.0	-	-	-	278.9	-	295.3	-	-	232.6	237.0	-	
282.2	-	-	-	262.4	-	308.4	-	-	-	224.9	-	
295.3	-	-	-	248.0	224.9	321.5	-	-	-	213.2	188.3	
308.4	-	-	-	-	212.7	334.6	-	-	-	202.2	177.5	
321.5	-	-	-	-	200.6	347.8	-	-	-	-	167.6	
334.6	-	-	-	-	189.6	360.9	-	-	-	-	158.3	
347.8	-	-	-	-	-	374.0	-	-	-	-	149.7	
360.9	-	-	-	-	-	387.1	-	-	-	-	111.8	
374.0	-	-	-	-	-	400.3	-	-	-	-	106.3	
387.1	-	-	-	-	-	413.4	-	-	-	-	82.7	
400.3	-	-	-	-	-	426.5	-	-	-	-	67.5	
						439.6	-	-	-	-	54.2	

* Main boom angle 87°

Main boom angle 87°, 85°, 75°, 65°, 55° and 45°, capacities for intermediate boom positions are calculated by the crane control system IC-1

	0 lb	176,400 lb	352,800 lb	529,200 lb	705,600 lb	882,000 lb	992,100 lb
---	------	------------	------------	------------	------------	------------	------------

Operation

SWSL, SFSL

374,800 – 551,200 lb + 0 – 176,400 lb 49.2–78.7 ft 31.5 ft 32.2 ft/s 360° ASME B30.5												
236.2 ft + 275.6 ft						236.2 ft + 315.0 ft						
SWSL			SFSL			SWSL			SFSL			
0 lb			176,400 lb – 992,100 lb			0 lb			176,400 lb – 992,100 lb			
87°/85°		87°/85°		75°		65°		55°		45°		
1,000 lb												
ft												
91.9	277.8*	291.0*	-	-	-	-	-	-	-	-	-	
98.4	265.7*	289.9*	-	-	-	-	-	-	-	-	-	
111.5	233.7*	293.2	-	-	-	-	-	-	-	-	-	
124.7	207.9*	289.9	-	-	-	-	-	-	-	-	-	
137.8	185.6*	286.6	-	-	-	-	-	-	-	-	284.4	
150.9	166.9*	283.3	-	-	-	-	-	-	-	-	284.4	
164.0	150.6*	278.9	-	-	-	-	-	-	-	-	284.4	
177.2	136.0*	273.4	-	-	-	-	-	-	-	-	284.4	
190.3	120.4*	269.0	-	-	-	-	-	-	-	-	284.4	
203.4	106.9*	264.6	276.7	-	-	-	-	-	-	-	284.4	
216.5	95.0*	259.0	276.7	-	-	-	-	-	-	-	273.4	
229.7	84.7*	254.6	275.6	-	-	-	-	-	-	-	266.8	
242.8	75.4*	250.2	274.5	-	-	-	-	-	-	-	262.4	
255.9	67.0*	237.0	273.4	-	-	-	-	-	-	-	257.9	
269.0	59.5*	215.4	272.3	-	-	-	-	-	-	-	251.3	
282.2	52.7*	190.9	261.2	245.8	-	-	-	-	-	-	242.5	
295.3	39.7	164.7	240.3	232.6	-	-	-	-	-	-	224.9	
308.4	-	-	221.6	219.8	-	-	-	-	-	-	208.3	
321.5	-	-	205.5	208.1	-	-	-	-	-	-	192.9	
334.6	-	-	183.0	197.3	-	-	-	-	-	-	178.6	
347.8	-	-	-	187.4	160.1	-	-	-	-	-	165.3	
360.9	-	-	-	178.1	151.0	-	-	-	-	-	149.9	
374.0	-	-	-	169.5	142.6	-	-	-	-	-	133.4	
387.1	-	-	-	-	134.7	-	-	-	-	-	117.9	
400.3	-	-	-	-	127.4	-	-	-	-	-	104.3	
413.4	-	-	-	-	-	92.8	-	-	-	-	90.8	
426.5	-	-	-	-	-	88.2	82.2	-	-	-	82.2	
439.6	-	-	-	-	-	83.8	71.2	-	-	-	71.2	
452.8	-	-	-	-	-	-	58.2	-	-	-	58.2	
465.9	-	-	-	-	-	-	45.2	-	-	-	45.2	
479.0	-	-	-	-	-	-	34.6	-	-	-	34.6	
98.4	215.8*	223.8*	-	-	-	-	-	-	-	-	-	
111.5	211.9*	221.6*	-	-	-	-	-	-	-	-	-	
118.1	203.2*	222.7	-	-	-	-	-	-	-	-	-	
124.7	194.4*	222.7	-	-	-	-	-	-	-	-	-	
137.8	173.3*	220.5	-	-	-	-	-	-	-	-	217.2	
150.9	155.2*	218.0	-	-	-	-	-	-	-	-	217.2	
164.0	139.6*	215.2	-	-	-	-	-	-	-	-	217.2	
177.2	125.9*	211.6	-	-	-	-	-	-	-	-	217.2	
190.3	114.0*	207.7	-	-	-	-	-	-	-	-	215.0	
203.4	101.9*	203.7	-	-	-	-	-	-	-	-	213.8	
216.5	89.9*	200.0	205.5	-	-	-	-	-	-	-	211.6	
229.7	79.6*	196.0	205.5	-	-	-	-	-	-	-	208.3	
242.8	70.3*	191.8	205.5	-	-	-	-	-	-	-	203.9	
255.9	61.9*	187.6	205.3	-	-	-	-	-	-	-	200.6	
269.0	54.5*	183.2	203.9	-	-	-	-	-	-	-	197.3	
282.2	47.6*	179.0	202.6	-	-	-	-	-	-	-	194.0	
295.3	41.4*	174.6	200.4	178.4	-	-	-	-	-	-	191.8	
308.4	35.9*	167.3	198.9	178.4	-	-	-	-	-	-	187.4	
321.5	30.6*	148.6	197.1	177.9	-	-	-	-	-	-	184.1	
334.6	19.6	128.1	188.1	177.9	-	-	-	-	-	-	179.7	
347.8	-	-	174.4	177.9	-	-	-	-	-	-	166.4	
360.9	-	-	161.8	172.6	-	-	-	-	-	-	153.2	
374.0	-	-	143.7	164.2	135.1	-	-	-	-	-	142.2	
387.1	-	-	-	156.1	127.4	-	-	-	-	-	127.9	
400.3	-	-	-	148.8	120.2	-	-	-	-	-	113.5	
413.4	-	-	-	142.0	113.3	-	-	-	-	-	101.2	
426.5	-	-	-	-	106.9	-	-	-	-	-	88.4	
439.6	-	-	-	-	101.0	75.6	-	-	-	-	76.1	
452.8	-	-	-	-	-	71.4	-	-	-	-	68.1	
465.9	-	-	-	-	-	67.2	-	-	-	-	59.5	
479.0	-	-	-	-	-	63.1	-	-	-	-	48.1	
492.1	-	-	-	-	-	-	-	-	-	-	36.8	
518.4	-	-	-	-	-	-	-	-	-	-	16.8	

* Main boom angle 87°

Main boom angle 87°, 85°, 75°, 65°, 55° and 45°, capacities for intermediate boom positions are calculated by the crane control system IC-1

	0 lb	176,400 lb	352,800 lb	529,200 lb	705,600 lb	882,000 lb	992,100 lb
--	------	------------	------------	------------	------------	------------	------------

Operation

SWSL, SFSL

374,800 – 551,200 lb + 0 – 176,400 lb 49.2–78.7 ft 31.5 ft 32.2 ft/s 360° ASME B30.5									
236.2 ft + 354.3 ft					255.9 ft + 118.1 ft				
SWSL					SFSL				
0 lb					176,400 lb – 992,100 lb				
87°/85° 87°/85° 75° 65° 55° 45° 15°					87°/85° 87°/85° 75° 65° 55° 45° 15°				
ft	1,000 lb								
111.5	160.7*	168.2*	-	-	-	-	-	-	-
124.7	160.1*	165.8*	-	-	-	-	-	-	-
131.2	158.1*	166.2	-	-	-	-	-	-	-
137.8	156.1*	165.8	-	-	-	-	-	-	-
150.9	144.0*	163.8	-	-	-	-	-	162.0	-
164.0	128.8*	161.8	-	-	-	-	-	160.9	-
177.2	115.5*	159.6	-	-	-	-	-	159.8	-
190.3	104.1*	157.2	-	-	-	-	-	159.8	-
203.4	93.7*	154.8	-	-	-	-	-	157.6	-
216.5	84.4*	151.9	-	-	-	-	-	155.4	-
229.7	75.0*	149.3	147.7	-	-	-	-	154.3	-
242.8	65.7*	146.6	147.7	-	-	-	-	152.1	-
255.9	57.3*	143.7	147.7	-	-	-	-	148.8	-
269.0	49.8*	140.7	147.7	-	-	-	-	146.6	-
282.2	43.0*	136.5	147.5	-	-	-	-	143.3	-
295.3	36.8*	131.8	146.8	-	-	-	-	141.1	-
308.4	31.1*	127.2	146.2	-	-	-	-	138.9	-
321.5	26.0*	122.8	145.5	125.4	-	-	-	136.7	-
334.6	21.2*	118.2	144.0	125.4	-	-	-	133.4	-
347.8	16.8*	113.5	142.2	125.4	-	-	-	131.2	-
360.9	12.6*	108.9	139.6	125.2	-	-	-	127.9	-
374.0	-	-	136.7	125.2	-	-	-	125.7	-
387.1	-	-	134.3	125.2	-	-	-	121.3	-
400.3	-	-	127.6	125.0	108.0	-	-	115.7	-
413.4	-	-	112.7	125.0	106.5	-	-	109.1	-
426.5	-	-	-	125.0	100.1	-	-	96.8	-
439.6	-	-	-	122.6	94.1	-	-	84.9	-
452.8	-	-	-	117.1	88.6	-	-	73.6	-
465.9	-	-	-	-	83.3	-	-	62.8	-
479.0	-	-	-	-	78.3	55.6	-	57.3	-
492.1	-	-	-	-	-	51.4	48.1	-	-
518.4	-	-	-	-	-	43.9	28.0	-	-
531.5	-	-	-	-	-	-	17.9	-	-

55.8	553.4*	690.0*	-	-	-	-	-	-	-
59.1	526.9*	690.0*	-	-	-	-	-	-	-
65.6	480.6*	679.0*	-	-	-	-	-	-	-
72.2	440.9*	707.7	-	-	-	-	-	676.8	-
78.7	407.9*	698.9	-	-	-	-	-	676.8	-
85.3	379.2*	687.8	-	-	-	-	-	676.8	-
91.9	353.8*	672.4	-	-	-	-	-	676.8	-
98.4	330.7*	657.0	-	-	-	-	-	676.8	-
111.5	291.0*	626.1	-	-	-	-	-	668.0	-
124.7	250.2*	597.5	-	-	-	-	-	659.2	-
131.2	233.7*	571.0	687.8	-	-	-	-	646.0	-
137.8	204.6	531.3	652.6	-	-	-	-	639.3	-
144.4	191.1	496.0	621.7	-	-	-	-	604.1	-
150.9	-	-	590.8	-	-	-	-	568.8	-
164.0	-	-	535.7	-	-	-	-	509.3	-
177.2	-	-	489.4	-	-	-	-	458.6	-
190.3	-	-	451.9	420.0	-	-	-	414.5	-
203.4	-	-	-	389.1	-	-	-	377.0	-
216.5	-	-	-	361.6	-	-	-	343.9	-
229.7	-	-	-	337.3	-	-	-	313.1	-
242.8	-	-	-	-	-	-	-	286.6	-
255.9	-	-	-	-	272.3	-	-	262.4	-
269.0	-	-	-	-	255.7	-	-	240.3	-
282.2	-	-	-	-	-	-	-	213.8	-
295.3	-	-	-	-	-	-	-	187.4	-
308.4	-	-	-	-	-	-	-	163.1	-
321.5	-	-	-	-	-	-	-	146.6	-
334.6	-	-	-	-	-	-	-	126.8	-

* Main boom angle 87°

Main boom angle 87°, 85°, 75°, 65°, 55° and 45°, capacities for intermediate boom positions are calculated by the crane control system IC-1

	0 lb	176,400 lb	352,800 lb	529,200 lb	705,600 lb	882,000 lb	992,100 lb
---	------	------------	------------	------------	------------	------------	------------

Operation

SWSL, SFSL

374,800 – 551,200 lb + 0 – 176,400 lb 49.2–78.7 ft 31.5 ft 32.2 ft/s 360° ASME B30.5											
255.9 ft + 157.5 ft						255.9 ft + 196.9 ft					
SWSL						SFSL					
0 lb						176,400 lb – 992,100 lb					
87°/85° 87°/85° 75° 65° 55° 45° 15°						87°/85° 87°/85° 75° 65° 55° 45° 15°					
ft						ft					
1,000 lb						1,000 lb					
62.3	471.8*	555.6*	-	-	-	72.2	389.1*	443.1*	-	-	-
65.6	449.7*	555.6*	-	-	-	78.7	360.5*	440.9*	-	-	-
72.2	414.5*	549.0*	-	-	-	85.3	335.1*	437.6*	-	-	-
78.7	383.6*	566.6	-	-	-	91.9	312.0*	451.9	-	-	-
85.3	356.0*	564.4	-	-	-	98.4	292.1*	449.7	-	-	432.1
91.9	332.9*	557.8	-	-	-	111.5	257.9*	440.9	-	-	432.1
98.4	310.9*	551.2	-	-	-	124.7	230.4*	432.1	-	-	432.1
111.5	275.6*	533.5	-	-	-	137.8	207.2*	420.0	-	-	432.1
124.7	245.8*	513.7	-	-	-	150.9	187.4*	406.8	-	-	429.9
137.8	214.1*	493.8	-	-	-	164.0	167.8*	394.6	447.5	-	427.7
150.9	187.8*	474.0	562.2	-	-	177.2	148.8*	382.5	443.1	-	414.5
164.0	166.2*	443.1	531.3	-	-	190.3	132.7*	364.9	440.9	-	399.0
177.2	136.2	396.8	485.0	-	-	203.4	118.8*	345.0	415.6	-	385.8
190.3	-	-	445.3	-	-	216.5	96.8	296.5	384.7	-	357.1
203.4	-	-	413.4	-	-	229.7	-	-	359.4	-	328.5
216.5	-	-	383.6	353.8	-	242.8	-	-	335.1	305.3	299.8
229.7	-	-	-	329.6	-	255.9	-	-	314.2	286.6	275.6
242.8	-	-	-	308.6	-	269.0	-	-	-	270.1	253.5
255.9	-	-	-	289.9	-	282.2	-	-	-	255.7	233.7
269.0	-	-	-	272.3	-	295.3	-	-	-	241.4	216.1
282.2	-	-	-	-	232.6	308.4	-	-	-	228.2	203.9
295.3	-	-	-	-	220.5	321.5	-	-	-	-	193.6
308.4	-	-	-	-	209.2	334.6	-	-	-	-	182.8
321.5	-	-	-	-	-	347.8	-	-	-	-	172.8
334.6	-	-	-	-	-	360.9	-	-	-	-	126.8
347.8	-	-	-	-	-	374.0	-	-	-	-	119.7
360.9	-	-	-	-	-	387.1	-	-	-	-	100.1
374.0	-	-	-	-	-	400.3	-	-	-	-	86.0
						413.4	-	-	-	-	69.4

* Main boom angle 87°

Main boom angle 87°, 85°, 75°, 65°, 55° and 45°, capacities for intermediate boom positions are calculated by the crane control system IC-1

	0 lb	176,400 lb	352,800 lb	529,200 lb	705,600 lb	882,000 lb	992,100 lb
---	------	------------	------------	------------	------------	------------	------------

Operation

SWSL, SFSL

374,800 – 551,200 lb + 0 – 176,400 lb 49.2–78.7 ft 31.5 ft 32.2 ft/s 360° ASME B30.5										
255.9 ft + 236.2 ft						255.9 ft + 275.6 ft				
SWSL			SFSL			SWSL			SFSL	
0 lb		176,400 lb – 992,100 lb				0 lb		176,400 lb – 992,100 lb		
87°/85°		87°/85°		75°		65°		55°		45° 15°
1,000 lb										
ft										
85.3	313.1*	351.6*	-	-	-	-	-	-	-	-
91.9	291.0*	349.4*	-	-	-	-	-	-	-	-
98.4	272.3*	356.0	-	-	-	-	-	-	-	-
111.5	240.3*	354.9	-	-	-	-	-	-	343.9	-
124.7	213.6*	350.5	-	-	-	-	-	-	343.9	-
137.8	191.4*	345.0	-	-	-	-	-	-	343.9	-
150.9	172.4*	338.4	-	-	-	-	-	-	343.9	-
164.0	156.1*	330.7	-	-	-	-	-	-	343.9	-
177.2	138.7*	323.0	-	-	-	-	-	-	343.9	-
190.3	123.2*	316.4	345.0	-	-	-	-	-	339.5	-
203.4	109.8*	307.5	343.9	-	-	-	-	-	326.3	-
216.5	97.9*	299.8	340.6	-	-	-	-	-	317.5	-
229.7	87.5*	283.3	338.4	-	-	-	-	-	308.6	-
242.8	78.3*	251.3	324.1	-	-	-	-	-	302.0	-
255.9	61.5	217.4	303.1	-	-	-	-	-	277.8	-
269.0	-	-	285.5	260.1	-	-	-	-	255.7	-
282.2	-	-	269.0	244.7	-	-	-	-	235.9	-
295.3	-	-	246.9	230.4	-	-	-	-	217.2	-
308.4	-	-	-	218.5	-	-	-	-	200.6	-
321.5	-	-	-	207.0	-	-	-	-	184.1	-
334.6	-	-	-	196.2	170.4	-	-	-	169.8	-
347.8	-	-	-	-	160.7	-	-	-	155.4	-
360.9	-	-	-	-	151.9	-	-	-	138.9	-
374.0	-	-	-	-	143.5	-	-	-	122.4	-
387.1	-	-	-	-	-	-	-	-	107.1	-
400.3	-	-	-	-	-	-	-	95.9	92.2	-
413.4	-	-	-	-	-	-	-	91.1	82.5	-
426.5	-	-	-	-	-	-	-	-	71.4	-
439.6	-	-	-	-	-	-	-	-	57.5	-
452.8	-	-	-	-	-	-	-	-	43.4	-
91.9	263.5*	274.5*	-	-	-	-	-	-	-	-
98.4	256.8*	273.4*	-	-	-	-	-	-	-	-
111.5	226.0*	275.6	-	-	-	-	-	-	-	-
124.7	200.6*	273.4	-	-	-	-	-	-	266.8	-
137.8	179.2*	271.2	-	-	-	-	-	-	266.8	-
150.9	160.9*	267.9	-	-	-	-	-	-	266.8	-
164.0	145.3*	263.5	-	-	-	-	-	-	266.8	-
177.2	131.6*	259.0	-	-	-	-	-	-	266.8	-
190.3	118.8*	254.6	-	-	-	-	-	-	266.8	-
203.4	105.4*	250.2	263.5	-	-	-	-	-	266.8	-
216.5	93.5*	245.8	262.4	-	-	-	-	-	260.1	-
229.7	83.1*	241.4	262.4	-	-	-	-	-	253.5	-
242.8	73.9*	235.9	260.1	-	-	-	-	-	246.9	-
255.9	65.7*	231.5	260.1	-	-	-	-	-	242.5	-
269.0	58.2*	219.1	257.9	-	-	-	-	-	238.1	-
282.2	51.6*	194.9	257.9	232.6	-	-	-	-	233.7	-
295.3	37.9	169.1	249.1	224.9	-	-	-	-	220.5	-
308.4	-	-	229.3	213.0	-	-	-	-	202.8	-
321.5	-	-	212.5	201.5	-	-	-	-	187.4	-
334.6	-	-	193.6	191.1	-	-	-	-	173.1	-
347.8	-	-	-	181.4	-	-	-	-	158.7	-
360.9	-	-	-	172.4	144.4	-	-	-	146.6	-
374.0	-	-	-	164.0	136.2	-	-	-	133.4	-
387.1	-	-	-	-	128.5	-	-	-	119.0	-
400.3	-	-	-	-	121.5	-	-	-	104.9	-
413.4	-	-	-	-	114.9	-	-	-	91.5	-
426.5	-	-	-	-	-	78.3	-	-	78.3	-
439.6	-	-	-	-	-	74.1	-	-	69.0	-
452.8	-	-	-	-	-	70.1	-	-	60.4	-
465.9	-	-	-	-	-	-	-	-	48.3	-
479.0	-	-	-	-	-	-	-	-	36.2	-
492.1	-	-	-	-	-	-	-	-	23.8	-

* Main boom angle 87°

Main boom angle 87°, 85°, 75°, 65°, 55° and 45°, capacities for intermediate boom positions are calculated by the crane control system IC-1

	0 lb	176,400 lb	352,800 lb	529,200 lb	705,600 lb	882,000 lb	992,100 lb
---	------	------------	------------	------------	------------	------------	------------

Operation

SWSL, SFSL

374,800 – 551,200 lb + 0–176,400 lb 49.2–78.7 ft 31.5 ft 32.2 ft/s 360° ASME B30.5																
255.9 ft + 315.0 ft						255.9 ft + 354.3 ft										
0 lb		SWSL 176,400 lb – 992,100 lb				SFSL	0 lb		SWSL 176,400 lb – 992,100 lb				SFSL			
		87°/85°	87°/85°	75°	65°	55°	45°			87°/85°	87°/85°	75°	65°	55°	45°	15°
ft		1,000 lb														
98.4	204.1*	211.4*	-	-	-	-	-	111.5	152.3*	159.0*	-	-	-	-	-	-
111.5	201.7*	209.9*	-	-	-	-	-	124.7	151.7*	157.4*	-	-	-	-	-	-
118.1	197.9*	211.4	-	-	-	-	-	131.2	149.8*	157.6	-	-	-	-	-	-
124.7	187.4*	211.4	-	-	-	-	-	137.8	147.9*	157.4	-	-	-	-	-	-
137.8	166.9*	209.2	-	-	-	-	-	150.9	138.2*	155.9	-	-	-	-	-	153.2
150.9	149.3*	206.8	-	-	-	-	-	164.0	123.5*	153.9	-	-	-	-	-	153.2
164.0	134.3*	203.9	-	-	-	-	-	177.2	110.9*	151.9	-	-	-	-	-	152.1
177.2	121.0*	200.8	-	-	-	-	-	190.3	99.4*	149.7	-	-	-	-	-	152.1
190.3	109.3*	197.1	-	-	-	-	-	203.4	89.5*	147.3	-	-	-	-	-	151.0
203.4	99.0*	193.6	-	-	-	-	-	216.5	80.5*	144.6	-	-	-	-	-	148.8
216.5	88.6*	189.8	195.6	-	-	-	-	229.7	72.5*	142.2	-	-	-	-	-	147.7
229.7	78.3*	186.1	195.6	-	-	-	-	242.8	64.4*	139.6	140.7	-	-	-	-	145.5
242.8	69.0*	182.5	195.6	-	-	-	-	255.9	56.0*	136.9	140.7	-	-	-	-	143.3
255.9	60.6*	179.0	195.6	-	-	-	-	269.0	48.5*	134.0	140.7	-	-	-	-	140.0
269.0	53.1*	175.5	194.4	-	-	-	-	282.2	41.9*	130.7	140.7	-	-	-	-	137.8
282.2	46.5*	172.0	193.3	-	-	-	-	295.3	35.7*	127.0	140.4	-	-	-	-	135.6
295.3	40.3*	168.4	191.4	-	-	-	-	308.4	30.0*	123.2	140.0	-	-	-	-	133.4
308.4	34.8*	164.9	190.5	169.8	-	-	-	321.5	24.9*	119.5	139.6	-	-	-	-	131.2
321.5	29.5*	161.7	189.2	169.1	-	-	-	334.6	20.1*	115.7	138.5	119.5	-	-	-	129.0
334.6	18.1	131.6	185.8	169.1	-	-	-	347.8	15.7*	112.0	137.6	119.5	-	-	-	126.8
347.8	-	-	180.3	169.1	-	-	-	360.9	11.7*	108.2	136.0	119.3	-	-	-	123.5
360.9	-	-	167.1	165.6	-	-	-	374.0	-	101.9	133.8	119.3	-	-	-	121.3
374.0	-	-	152.1	157.2	-	-	-	387.1	-	-	132.1	119.3	-	-	-	119.0
387.1	-	-	-	149.5	121.0	-	-	400.3	-	-	130.5	119.0	-	-	-	113.5
400.3	-	-	-	142.2	114.0	-	-	413.4	-	-	119.5	119.0	100.3	-	-	107.1
413.4	-	-	-	135.6	107.4	-	-	426.5	-	-	-	119.0	94.1	-	-	95.5
426.5	-	-	-	-	101.2	-	-	439.6	-	-	-	116.6	88.4	-	-	84.0
439.6	-	-	-	-	95.2	-	-	452.8	-	-	-	111.1	82.9	-	-	73.0
452.8	-	-	-	-	89.9	63.9	64.6	465.9	-	-	-	-	77.8	-	-	62.2
465.9	-	-	-	-	-	60.6	58.0	479.0	-	-	-	-	73.0	-	-	53.1
479.0	-	-	-	-	-	56.4	48.9	492.1	-	-	-	-	68.3	44.8	47.6	
492.1	-	-	-	-	-	52.5	38.4	518.4	-	-	-	-	-	37.7	28.4	
518.4	-	-	-	-	-	-	17.0	531.5	-	-	-	-	-	34.2	19.2	

* Main boom angle 87°

Main boom angle 87°, 85°, 75°, 65°, 55° and 45°, capacities for intermediate boom positions are calculated by the crane control system IC-1

	0 lb	176,400 lb	352,800 lb	529,200 lb	705,600 lb	882,000 lb	992,100 lb
---	------	------------	------------	------------	------------	------------	------------

Operation

SWSL, SFSL

374,800 – 551,200 lb + 0 – 176,400 lb 49.2–78.7 ft 31.5 ft 32.2 ft/s 360° ASME B30.5										
275.6 ft + 118.1 ft						275.6 ft + 157.5 ft				
SWSL			SFSL			SWSL			SFSL	
0 lb		176,400 lb – 992,100 lb				0 lb		176,400 lb – 992,100 lb		
87°/85°		87°/85°		75°		65°		55°		45° 15°
1,000 lb										
55.8	531.3*	628.3*	-	-	-	-	-	-	-	-
59.1	504.9*	628.3*	-	-	-	-	-	-	-	-
65.6	463.0*	619.5*	-	-	-	-	-	-	-	-
72.2	425.5*	643.8	-	-	-	-	-	-	615.1	-
78.7	393.5*	634.9	-	-	-	-	-	-	615.1	-
85.3	366.0*	626.1	-	-	-	-	-	-	615.1	-
91.9	341.7*	612.9	-	-	-	-	-	-	615.1	-
98.4	319.7*	601.9	-	-	-	-	-	-	615.1	-
111.5	283.3*	575.4	-	-	-	-	-	-	610.7	-
124.7	248.0*	553.4	-	-	-	-	-	-	599.7	-
137.8	215.4*	529.1	632.7	-	-	-	-	-	590.8	-
144.4	187.0	504.9	610.7	-	-	-	-	-	576.5	-
150.9	-	-	582.0	-	-	-	-	-	562.2	-
164.0	-	-	526.9	-	-	-	-	-	502.7	-
177.2	-	-	482.8	-	-	-	-	-	451.9	-
190.3	-	-	443.1	-	-	-	-	-	407.9	-
203.4	-	-	-	377.0	-	-	-	-	370.4	-
216.5	-	-	-	351.6	-	-	-	-	335.1	-
229.7	-	-	-	327.4	-	-	-	-	306.4	-
242.8	-	-	-	-	-	-	-	-	280.0	-
255.9	-	-	-	-	259.0	-	-	-	255.7	-
269.0	-	-	-	-	243.6	-	-	-	233.7	-
282.2	-	-	-	-	231.5	-	-	-	213.8	-
295.3	-	-	-	-	-	-	-	-	189.6	-
308.4	-	-	-	-	-	-	-	-	166.4	-
321.5	-	-	-	-	-	-	-	-	143.3	-
334.6	-	-	-	-	-	-	-	-	126.8	-
347.8	-	-	-	-	-	-	-	-	111.3	-
360.9	-	-	-	-	-	-	-	-	90.6	-
65.6	434.3*	504.9*	-	-	-	-	-	-	-	-
72.2	400.1*	500.4*	-	-	-	-	-	-	-	-
78.7	370.4*	513.7	-	-	-	-	-	-	-	-
85.3	343.9*	513.7	-	-	-	-	-	-	493.8	-
91.9	320.8*	509.3	-	-	-	-	-	-	493.8	-
98.4	300.9*	502.7	-	-	-	-	-	-	493.8	-
111.5	265.7*	487.2	-	-	-	-	-	-	493.8	-
124.7	238.1*	471.8	-	-	-	-	-	-	493.8	-
137.8	211.2*	454.2	-	-	-	-	-	-	487.2	-
150.9	185.2*	439.8	-	-	-	-	-	-	480.6	-
157.5	173.9*	432.1	507.1	-	-	-	-	-	470.7	-
164.0	163.6*	424.4	507.1	-	-	-	-	-	465.2	-
177.2	132.5	396.8	476.2	-	-	-	-	-	449.7	-
190.3	-	-	438.7	-	-	-	-	-	414.5	-
203.4	-	-	405.7	-	-	-	-	-	374.8	-
216.5	-	-	377.0	-	-	-	-	-	341.7	-
229.7	-	-	351.6	318.6	-	-	-	-	310.9	-
242.8	-	-	-	298.7	-	-	-	-	284.4	-
255.9	-	-	-	281.1	-	-	-	-	260.1	-
269.0	-	-	-	264.6	-	-	-	-	238.1	-
282.2	-	-	-	-	-	-	-	-	219.4	-
295.3	-	-	-	-	208.6	-	-	-	200.6	-
308.4	-	-	-	-	197.8	-	-	-	184.1	-
321.5	-	-	-	-	-	-	-	-	163.1	-
334.6	-	-	-	-	-	-	-	-	143.3	-
347.8	-	-	-	-	-	-	-	-	124.6	-
360.9	-	-	-	-	-	-	-	-	107.1	-
374.0	-	-	-	-	-	-	-	-	96.8	-
387.1	-	-	-	-	-	-	-	-	80.5	-
400.3	-	-	-	-	-	-	-	-	63.1	-

* Main boom angle 87°

Main boom angle 87°, 85°, 75°, 65°, 55° and 45°, capacities for intermediate boom positions are calculated by the crane control system IC-1

	0 lb	176,400 lb	352,800 lb	529,200 lb	705,600 lb	882,000 lb	992,100 lb
---	------	------------	------------	------------	------------	------------	------------

Operation

SWSL, SFSL

374,800 – 551,200 lb + 0 – 176,400 lb 49.2–78.7 ft 31.5 ft 32.2 ft/s 360° ASME B30.5										
275.6 ft + 196.9 ft						275.6 ft + 236.2 ft				
SWSL			SFSL			SWSL			SFSL	
0 lb			176,400 lb – 992,100 lb			0 lb			176,400 lb – 992,100 lb	
87°/85°			87°/85°			75°			65°	
55°			45°			15°				
ft 1,000 lb										
78.7	347.2*	405.7*	-	-	-	-	-	-	-	-
85.3	323.0*	402.3*	-	-	-	-	-	-	-	-
91.9	300.9*	413.4	-	-	-	-	-	-	-	-
98.4	282.2*	412.3	-	-	-	-	-	-	396.8	-
111.5	249.1*	405.7	-	-	-	-	-	-	396.8	-
124.7	222.7*	395.7	-	-	-	-	-	-	396.8	-
137.8	200.2*	385.8	-	-	-	-	-	-	396.8	-
150.9	181.0*	374.8	-	-	-	-	-	-	396.8	-
164.0	164.7*	363.8	-	-	-	-	-	-	390.2	-
177.2	146.8*	352.7	409.0	-	-	-	-	-	383.6	-
190.3	130.7*	342.8	403.4	-	-	-	-	-	372.6	-
203.4	116.8*	331.8	400.1	-	-	-	-	-	359.4	-
216.5	93.9	304.2	379.2	-	-	-	-	-	350.5	-
229.7	-	-	352.7	-	-	-	-	-	321.9	-
242.8	-	-	329.6	-	-	-	-	-	293.2	-
255.9	-	-	308.6	276.7	-	-	-	-	269.0	-
269.0	-	-	291.0	260.1	-	-	-	-	246.9	-
282.2	-	-	-	245.8	-	-	-	-	227.1	-
295.3	-	-	-	232.6	-	-	-	-	209.4	-
308.4	-	-	-	220.5	-	-	-	-	191.8	-
321.5	-	-	-	-	182.1	-	-	-	176.4	-
334.6	-	-	-	-	172.8	-	-	-	162.0	-
347.8	-	-	-	-	164.0	-	-	-	145.5	-
360.9	-	-	-	-	-	-	-	-	127.9	-
374.0	-	-	-	-	-	-	-	110.2	111.3	-
387.1	-	-	-	-	-	-	-	103.8	95.2	-
400.3	-	-	-	-	-	-	-	-	83.8	-
413.4	-	-	-	-	-	-	-	-	72.8	-
426.5	-	-	-	-	-	-	-	-	57.5	-
439.6	-	-	-	-	-	-	-	-	42.1	-
85.3	300.9*	325.2*	-	-	-	-	-	-	-	-
91.9	280.0*	324.1*	-	-	-	-	-	-	-	-
98.4	262.4*	320.8*	-	-	-	-	-	-	-	-
105.0	246.9*	330.7	-	-	-	-	-	-	-	-
111.5	231.5*	328.5	-	-	-	-	-	-	317.5	-
124.7	205.9*	324.1	-	-	-	-	-	-	317.5	-
137.8	184.3*	318.6	-	-	-	-	-	-	317.5	-
150.9	166.2*	312.0	-	-	-	-	-	-	317.5	-
164.0	150.4*	305.3	-	-	-	-	-	-	317.5	-
177.2	136.7*	297.6	-	-	-	-	-	-	317.5	-
190.3	121.3*	291.0	324.1	-	-	-	-	-	313.1	-
203.4	108.0*	283.3	320.8	-	-	-	-	-	306.4	-
216.5	96.3*	276.7	320.8	-	-	-	-	-	295.4	-
229.7	86.0*	269.0	315.3	-	-	-	-	-	288.8	-
242.8	76.7*	255.7	313.1	-	-	-	-	-	282.2	-
255.9	59.1	222.7	297.6	-	-	-	-	-	271.2	-
269.0	-	-	280.0	250.2	-	-	-	-	249.1	-
282.2	-	-	263.5	235.9	-	-	-	-	229.3	-
295.3	-	-	249.1	222.7	-	-	-	-	210.5	-
308.4	-	-	226.0	211.0	-	-	-	-	194.0	-
321.5	-	-	-	200.0	-	-	-	-	178.6	-
334.6	-	-	-	189.6	-	-	-	-	163.1	-
347.8	-	-	-	179.9	151.9	-	-	-	149.9	-
360.9	-	-	-	-	143.3	-	-	-	136.7	-
374.0	-	-	-	-	135.1	-	-	-	121.3	-
387.1	-	-	-	-	127.9	-	-	-	106.5	-
400.3	-	-	-	-	-	-	-	-	91.9	-
413.4	-	-	-	-	-	-	-	80.5	78.0	-
426.5	-	-	-	-	-	-	-	75.6	68.8	-
439.6	-	-	-	-	-	-	-	-	58.9	-
452.8	-	-	-	-	-	-	-	-	45.9	-
465.9	-	-	-	-	-	-	-	-	32.8	-

* Main boom angle 87°

Main boom angle 87°, 85°, 75°, 65°, 55° and 45°, capacities for intermediate boom positions are calculated by the crane control system IC-1

	0 lb	176,400 lb	352,800 lb	529,200 lb	705,600 lb	882,000 lb	992,100 lb
---	------	------------	------------	------------	------------	------------	------------

Operation

SWSL, SFSL

374,800 – 551,200 lb + 0 – 176,400 lb 49.2–78.7 ft 31.5 ft 32.2 ft/s 360° ASME B30.5																							
275.6 ft + 275.6 ft						275.6 ft + 315.0 ft																	
SWSL			SFSL			SWSL			SFSL														
0 lb			176,400 lb – 992,100 lb			0 lb			176,400 lb – 992,100 lb														
87°/85°			87°/85°			75°			65°			55°			45°			15°					
ft												1,000 lb											
91.9	248.0*	257.9*	-	-	-	-	-	-	-	-	-	105.0	188.5*	196.0*	-	-	-	-	-	-	-	-	
98.4	242.5*	256.8*	-	-	-	-	-	-	-	-	-	111.5	188.5*	194.4*	-	-	-	-	-	-	-	-	
111.5	217.6*	259.0	-	-	-	-	-	-	-	-	-	124.7	179.9*	195.3	-	-	-	-	-	-	-	-	
124.7	193.1*	257.9	-	-	-	-	-	-	-	-	137.8	160.1*	193.6	-	-	-	-	-	-	-	251.3	189.6	
137.8	172.4*	254.6	-	-	-	-	-	-	-	-	150.9	143.3*	191.4	-	-	-	-	-	-	-	251.3	189.6	
150.9	154.8*	251.3	-	-	-	-	-	-	-	-	164.0	128.5*	188.7	-	-	-	-	-	-	-	251.3	189.6	
164.0	139.6*	248.0	-	-	-	-	-	-	-	-	177.2	116.0*	185.8	-	-	-	-	-	-	-	251.3	189.6	
177.2	126.3*	243.6	-	-	-	-	-	-	-	-	190.3	104.5*	182.3	-	-	-	-	-	-	-	251.3	188.5	
190.3	114.6*	239.2	-	-	-	-	-	-	-	-	203.4	94.6*	178.6	-	-	-	-	-	-	-	251.3	187.4	
203.4	103.6*	234.8	248.0	-	-	-	-	-	-	-	216.5	85.5*	175.0	-	-	-	-	-	-	-	251.3	186.3	
216.5	91.9*	230.4	248.0	-	-	-	-	-	-	-	229.7	76.5*	171.5	180.1	-	-	-	-	-	-	246.9	185.2	
229.7	81.6*	226.0	246.9	-	-	-	-	-	-	-	242.8	67.5*	167.8	180.1	-	-	-	-	-	-	240.3	180.8	
242.8	72.3*	220.5	244.7	-	-	-	-	-	-	-	255.9	59.3*	164.2	180.1	-	-	-	-	-	-	233.7	175.3	
255.9	64.2*	216.1	244.7	-	-	-	-	-	-	-	269.0	51.8*	160.7	179.9	-	-	-	-	-	-	227.1	173.1	
269.0	56.9*	211.2	244.7	-	-	-	-	-	-	-	282.2	45.2*	157.0	178.1	-	-	-	-	-	-	222.7	169.8	
282.2	50.0*	198.6	242.5	-	-	-	-	-	-	-	295.3	39.0*	153.4	177.0	-	-	-	-	-	-	219.4	167.6	
295.3	35.7	173.3	241.4	215.6	-	-	-	-	-	-	308.4	33.5*	149.7	174.8	-	-	-	-	-	-	213.8	164.2	
308.4	-	-	231.5	203.7	-	-	-	-	-	-	321.5	28.4*	146.2	173.5	155.9	-	-	-	-	-	197.3	162.0	
321.5	-	-	219.4	192.7	-	-	-	-	-	-	334.6	16.1	135.1	171.5	155.0	-	-	-	-	-	180.8	158.7	
334.6	-	-	203.0	182.5	-	-	-	-	-	-	347.8	-	-	169.3	155.0	-	-	-	-	-	166.4	155.4	
347.8	-	-	178.1	173.3	-	-	-	-	-	-	360.9	-	-	166.0	155.0	-	-	-	-	-	153.2	142.2	
360.9	-	-	-	164.7	-	-	-	-	-	-	374.0	-	-	160.1	149.5	-	-	-	-	-	140.0	130.1	
374.0	-	-	-	156.5	127.6	-	-	-	-	-	387.1	-	-	-	142.0	-	-	-	-	-	129.0	119.0	
387.1	-	-	-	149.3	120.2	-	-	-	-	-	400.3	-	-	-	134.9	105.6	-	-	-	-	115.7	109.6	
400.3	-	-	-	-	113.3	-	-	-	-	-	413.4	-	-	-	128.5	99.4	-	-	-	-	103.0	97.9	
413.4	-	-	-	-	106.9	-	-	-	-	-	426.5	-	-	-	122.4	93.5	-	-	-	-	89.9	85.8	
426.5	-	-	-	-	101.0	-	-	-	-	-	439.6	-	-	-	-	87.7	-	-	-	-	77.2	74.3	
439.6	-	-	-	-	-	-	-	-	-	-	452.8	-	-	-	-	82.7	-	-	-	-	65.5	63.1	
452.8	-	-	-	-	-	-	-	-	-	-	465.9	-	-	-	-	77.6	52.0	-	-	-	62.2	53.4	
465.9	-	-	-	-	-	-	-	-	-	-	479.0	-	-	-	-	-	48.1	-	-	-	59.1	47.4	
479.0	-	-	-	-	-	-	-	-	-	-	492.1	-	-	-	-	-	44.3	-	-	-	36.8	37.3	
492.1	-	-	-	-	-	-	-	-	-	-	505.3	-	-	-	-	-	40.8	-	-	-	25.6	27.3	
505.3	-	-	-	-	-	-	-	-	-	-	518.4	-	-	-	-	-	-	-	-	-	14.1	17.4	

* Main boom angle 87°

Main boom angle 87°, 85°, 75°, 65°, 55° and 45°, capacities for intermediate boom positions are calculated by the crane control system IC-1

	0 lb	176,400 lb	352,800 lb	529,200 lb	705,600 lb	882,000 lb	992,100 lb
--	------	------------	------------	------------	------------	------------	------------

Operation

SWSL, SFSL

374,800 – 551,200 lb + 0 – 176,400 lb 49.2–78.7 ft 31.5 ft 32.2 ft/s 360° ASME B30.5										
275.6 ft + 354.3 ft						295.3 ft + 118.1 ft				
SWSL						SFSL				
0 lb						176,400 lb – 992,100 lb				
87°/85° 87°/85° 75° 65° 55° 45° 15°						87°/85° 87°/85° 75° 65° 55° 45° 15°				
ft						ft				
1,000 lb						1,000 lb				
111.5	143.5*	149.9*	-	-	-	55.8	509.3*	573.2*	-	-
124.7	143.1*	148.4*	-	-	-	59.1	485.0*	573.2*	-	-
131.2	141.8*	148.8	-	-	-	65.6	445.3*	564.4*	-	-
137.8	140.4*	148.8	-	-	-	72.2	410.1*	582.0	-	-
150.9	132.1*	147.3	-	-	-	78.7	379.2*	577.6	-	560.0
164.0	117.9*	145.5	-	-	-	85.3	352.7*	568.8	-	560.0
177.2	105.6*	143.7	-	-	-	91.9	329.6*	560.0	-	560.0
190.3	94.8*	141.5	-	-	-	98.4	309.7*	549.0	-	560.0
203.4	85.1*	139.1	-	-	-	111.5	274.5*	526.9	-	560.0
216.5	76.5*	136.7	-	-	-	124.7	244.7*	507.1	-	553.4
229.7	68.6*	134.3	-	-	-	137.8	212.5*	491.6	-	546.7
242.8	61.5*	131.8	133.2	-	-	144.4	182.5	482.8	568.8	532.4
255.9	54.7*	129.4	133.2	-	-	150.9	-	-	566.6	524.7
269.0	47.2*	126.8	133.2	-	-	164.0	-	-	520.3	496.0
282.2	40.6*	124.1	133.2	-	-	177.2	-	-	476.2	445.3
295.3	34.4*	121.0	133.2	-	-	190.3	-	-	437.6	401.2
308.4	28.9*	118.2	132.9	-	-	203.4	-	-	-	361.6
321.5	23.8*	115.1	132.7	-	-	216.5	-	-	339.5	328.5
334.6	19.0*	112.2	131.4	112.7	-	229.7	-	-	317.5	297.6
347.8	14.8*	109.1	131.0	112.2	-	242.8	-	-	297.6	271.2
360.9	-	106.3	130.5	112.2	-	255.9	-	-	-	246.9
374.0	-	103.2	129.0	112.2	-	269.0	-	-	-	227.1
387.1	-	-	128.3	112.2	-	282.2	-	-	230.4	207.2
400.3	-	-	127.4	111.8	-	295.3	-	-	218.5	189.6
413.4	-	-	125.9	111.8	-	308.4	-	-	-	167.6
426.5	-	-	-	111.8	86.2	321.5	-	-	-	145.5
439.6	-	-	-	110.0	80.7	334.6	-	-	-	124.6
452.8	-	-	-	104.7	75.4	347.8	-	-	-	107.6
465.9	-	-	-	99.6	70.5	360.9	-	-	-	96.1
479.0	-	-	-	-	65.9	374.0	-	-	-	77.6
492.1	-	-	-	-	61.5	-	-	-	-	-
505.3	-	-	-	-	57.3	-	-	-	-	-
518.4	-	-	-	-	-	-	-	-	-	-
531.5	-	-	-	-	-	-	-	-	-	-
544.6	-	-	-	-	-	-	-	-	-	-
					33.1					34.6
					29.8					26.7
					26.5					17.9
					23.6					-

* Main boom angle 87°

Main boom angle 87°, 85°, 75°, 65°, 55° and 45°, capacities for intermediate boom positions are calculated by the crane control system IC-1

	0 lb	176,400 lb	352,800 lb	529,200 lb	705,600 lb	882,000 lb	992,100 lb
---	------	------------	------------	------------	------------	------------	------------

Operation

SWSL, SFSL

374,800 – 551,200 lb + 0 – 176,400 lb 49.2–78.7 ft 31.5 ft 32.2 ft/s 360° ASME B30.5										
295.3 ft + 157.5 ft						295.3 ft + 196.9 ft				
SWSL						SFSL				
0 lb						176,400 lb – 992,100 lb				
87°/85° 87°/85° 75° 65° 55° 45° 15°						87°/85° 87°/85° 75° 65° 55° 45° 15°				
ft						ft				
1,000 lb						1,000 lb				
65.6	416.7*	460.8*	-	-	-	78.7	334.0*	372.6*	-	-
72.2	384.7*	458.6*	-	-	-	85.3	310.9*	369.3*	-	-
78.7	356.0*	454.2*	-	-	-	91.9	289.9*	378.1	-	-
85.3	331.8*	469.6	-	-	-	98.4	272.3*	378.1	-	-
91.9	309.7*	465.2	-	-	-	111.5	240.3*	371.5	-	-
98.4	289.9*	458.6	-	-	-	124.7	215.0*	362.7	-	-
111.5	256.8*	447.5	-	-	-	137.8	193.3*	352.7	-	-
124.7	229.3*	432.1	-	-	-	150.9	174.8*	342.8	-	-
137.8	207.7*	416.7	-	-	-	164.0	159.2*	331.8	-	-
150.9	182.5*	403.4	-	-	-	177.2	144.6*	323.0	373.7	-
157.5	171.3*	396.8	463.0	-	-	190.3	128.8*	314.2	370.4	-
164.0	161.2*	391.3	463.0	-	-	203.4	115.1*	305.3	362.7	-
177.2	142.9*	378.1	451.9	-	-	216.5	91.1	296.5	357.1	-
190.3	-	-	432.1	-	-	229.7	-	-	347.2	-
203.4	-	-	399.0	-	-	242.8	-	-	324.1	-
216.5	-	-	370.4	-	-	255.9	-	-	304.2	265.7
229.7	-	-	345.0	306.4	-	269.0	-	-	285.5	250.2
242.8	-	-	-	287.7	-	282.2	-	-	-	235.9
255.9	-	-	-	270.1	-	295.3	-	-	-	222.7
269.0	-	-	-	254.6	-	308.4	-	-	-	211.9
282.2	-	-	-	240.3	-	321.5	-	-	201.3	-
295.3	-	-	-	-	196.0	334.6	-	-	-	162.0
308.4	-	-	-	-	185.8	347.8	-	-	-	153.9
321.5	-	-	-	-	176.4	360.9	-	-	-	146.2
334.6	-	-	-	-	-	374.0	-	-	-	-
347.8	-	-	-	-	-	387.1	-	-	-	94.1
360.9	-	-	-	-	-	400.3	-	-	-	88.6
374.0	-	-	-	-	-	413.4	-	-	-	-
387.1	-	-	-	-	-	426.5	-	-	-	-
400.3	-	-	-	-	-	439.6	-	-	-	-
413.4	-	-	-	-	-	452.8	-	-	-	-

* Main boom angle 87°

Main boom angle 87°, 85°, 75°, 65°, 55° and 45°, capacities for intermediate boom positions are calculated by the crane control system IC-1

	0 lb	176,400 lb	352,800 lb	529,200 lb	705,600 lb	882,000 lb	992,100 lb
---	------	------------	------------	------------	------------	------------	------------

Operation

SWSL, SFSL

295.3 ft + 236.2 ft						295.3 ft + 275.6 ft						
SWSL			SFSL			SWSL			SFSL			
0 lb			176,400 lb - 992,100 lb			0 lb			176,400 lb - 992,100 lb			
87°/85°		87°/85°		75°		65°		55°		45°		
1,000 lb												
ft						ft						
85.3	282.2*	298.7*	-	-	-	91.9	232.6*	239.2*	-	-	-	
91.9	270.1*	297.6*	-	-	-	98.4	227.1*	239.2*	-	-	-	
98.4	252.4*	295.4*	-	-	-	111.5	209.0*	241.4	-	-	-	
105.0	237.5*	303.1	-	-	-	124.7	185.4*	240.3	-	-	-	
111.5	222.7*	302.0	-	-	-	137.8	165.6*	238.1	-	-	233.7	
124.7	198.4*	298.7	-	-	-	150.9	148.8*	234.8	-	-	233.7	
137.8	177.7*	293.2	-	-	-	164.0	134.0*	231.5	-	-	233.7	
150.9	159.8*	286.6	-	-	-	177.2	121.3*	226.0	-	-	233.7	
164.0	144.6*	280.0	-	-	-	190.3	110.0*	221.6	-	-	233.7	
177.2	131.4*	272.3	-	-	-	203.4	99.9*	217.6	-	-	233.7	
190.3	119.5*	265.7	296.5	-	-	216.5	90.2*	212.7	232.6	-	233.7	
203.4	106.3*	259.0	296.5	-	-	229.7	80.0*	208.1	231.5	-	224.9	
216.5	94.6*	252.4	293.2	-	-	242.8	71.0*	203.5	231.5	-	219.4	
229.7	84.4*	246.9	292.1	-	-	255.9	62.8*	198.9	229.3	-	212.7	
242.8	75.2*	240.3	285.5	-	-	269.0	55.6*	194.2	228.2	-	208.3	
255.9	56.7	227.1	282.2	-	-	282.2	48.7*	189.6	224.9	-	205.0	
269.0	-	-	274.5	-	-	295.3	33.5	177.3	222.7	-	200.6	
282.2	-	-	259.0	226.0	-	308.4	-	-	220.5	194.7	191.8	
295.3	-	-	244.7	213.8	-	321.5	-	-	215.0	184.1	175.3	
308.4	-	-	231.5	202.2	-	334.6	-	-	203.9	174.2	160.9	
321.5	-	-	-	191.4	-	347.8	-	-	188.9	165.1	147.7	
334.6	-	-	-	181.4	-	360.9	-	-	-	156.7	134.5	
347.8	-	-	-	172.4	-	374.0	-	-	-	149.0	122.4	
360.9	-	-	-	164.2	134.0	387.1	-	-	-	142.0	111.6	
374.0	-	-	-	-	126.3	400.3	-	-	-	135.1	104.9	
387.1	-	-	-	-	119.3	413.4	-	-	-	-	98.8	
400.3	-	-	-	-	112.7	426.5	-	-	-	-	93.0	
413.4	-	-	-	-	-	439.6	-	-	-	-	87.7	
426.5	-	-	-	-	67.2	452.8	-	-	-	-	53.8	
439.6	-	-	-	-	63.9	465.9	-	-	-	-	49.8	
452.8	-	-	-	-	-	479.0	-	-	-	-	46.1	
465.9	-	-	-	-	-	492.1	-	-	-	-	34.4	
479.0	-	-	-	-	-	505.3	-	-	-	-	22.5	

* Main boom angle 87°

Main boom angle 87°, 85°, 75°, 65°, 55° and 45°, capacities for intermediate boom positions are calculated by the crane control system IC-1

	0 lb	176,400 lb	352,800 lb	529,200 lb	705,600 lb	882,000 lb	992,100 lb
--	------	------------	------------	------------	------------	------------	------------

Operation

SWSL, SFSL

374,800 – 551,200 lb + 0 – 176,400 lb 49.2–78.7 ft 31.5 ft 32.2 ft/s 360° ASME B30.5											
295.3 ft + 315.0 ft					295.3 ft + 354.3 ft						
0 lb		SWSL 176,400 lb – 992,100 lb				0 lb		SWSL 176,400 lb – 992,100 lb			
87°/85°		87°/85°		75°		65°		55°		45°	
15°		15°		15°		15°		15°		15°	
1,000 lb					1,000 lb						
105.0	177.0*	183.4*	-	-	-	-	-	-	-	-	-
111.5	177.0*	182.8*	-	-	-	-	-	-	-	-	-
124.7	169.3*	183.2	-	-	-	-	-	-	-	-	-
137.8	153.4*	182.1	-	-	-	-	-	-	-	-	-
150.9	137.1*	180.1	-	-	-	-	-	-	-	-	177.5
164.0	123.0*	177.7	-	-	-	-	-	-	-	-	177.5
177.2	110.7*	174.8	-	-	-	-	-	-	-	-	177.5
190.3	99.9*	171.5	-	-	-	-	-	-	-	-	177.5
203.4	90.2*	168.2	-	-	-	-	-	-	-	-	176.4
216.5	81.6*	164.7	-	-	-	-	-	-	-	-	175.3
229.7	73.6*	161.4	170.0	-	-	-	-	-	-	-	175.3
242.8	65.9*	158.1	170.0	-	-	-	-	-	-	-	172.0
255.9	57.8*	154.5	170.0	-	-	-	-	-	-	-	167.6
269.0	50.5*	151.2	170.0	-	-	-	-	-	-	-	162.0
282.2	43.9*	147.9	168.4	-	-	-	-	-	-	-	159.8
295.3	37.9*	144.6	167.6	-	-	-	-	-	-	-	156.5
308.4	32.4*	141.3	166.7	-	-	-	-	-	-	-	154.3
321.5	27.3*	138.0	164.0	146.8	-	-	-	-	-	-	151.0
334.6	14.3	134.7	162.7	145.9	-	-	-	-	-	-	147.7
347.8	-	-	161.2	145.9	-	-	-	-	-	-	145.5
360.9	-	-	157.6	145.9	-	-	-	-	-	-	136.7
374.0	-	-	155.9	141.8	-	-	-	-	-	-	124.6
387.1	-	-	148.6	134.7	-	-	-	-	-	-	113.5
400.3	-	-	-	127.9	-	-	-	-	-	-	104.1
413.4	-	-	-	121.7	90.8	-	-	-	-	-	94.4
426.5	-	-	-	115.7	85.3	-	-	-	-	-	82.9
439.6	-	-	-	110.2	80.0	-	-	-	-	-	71.4
452.8	-	-	-	-	75.0	-	-	-	-	-	60.6
465.9	-	-	-	-	70.1	-	-	-	-	-	50.0
479.0	-	-	-	-	65.7	-	-	-	-	-	41.0
492.1	-	-	-	-	-	-	-	-	-	34.4	33.3
518.4	-	-	-	-	-	-	-	-	-	-	28.0
531.5	-	-	-	-	-	-	-	-	-	-	16.5
544.6	-	-	-	-	-	-	-	-	-	-	-
557.7	-	-	-	-	-	-	-	-	-	-	-

* Main boom angle 87°

Main boom angle 87°, 85°, 75°, 65°, 55° and 45°, capacities for intermediate boom positions are calculated by the crane control system IC-1

	0 lb	176,400 lb	352,800 lb	529,200 lb	705,600 lb	882,000 lb	992,100 lb
---	------	------------	------------	------------	------------	------------	------------

Operation

SWSL, SFSL

SWSL			SFSL			SWSL			SFSL							
0 lb			176,400 lb - 992,100 lb			0 lb			176,400 lb - 992,100 lb							
87°/85°			87°/85°			75°			65°		55°		45°		15°	
ft																
1,000 lb																
59.1	465.2*	515.9*	-	-	-	-	-	-	-	-						
65.6	427.7*	511.5*	-	-	-	-	-	-	-	-						
72.2	394.6*	524.7	-	-	-	-	-	507.1	-	-						
78.7	366.0*	524.7	-	-	-	-	-	507.1	-	-						
85.3	340.6*	515.9	-	-	-	-	-	507.1	-	-						
91.9	317.5*	507.1	-	-	-	-	-	507.1	-	-						
98.4	297.6*	498.2	-	-	-	-	-	507.1	-	-						
111.5	264.6*	478.4	-	-	-	-	-	507.1	-	-						
124.7	237.0*	460.8	-	-	-	-	-	507.1	-	-						
137.8	209.4*	445.3	-	-	-	-	-	500.4	-	-						
150.9	166.0	429.9	507.1	-	-	-	-	487.2	-	-						
164.0	-	-	498.2	-	-	-	-	465.2	-	-						
177.2	-	-	467.4	-	-	-	-	436.5	-	-						
190.3	-	-	429.9	-	-	-	-	392.4	-	-						
203.4	-	-	396.8	-	-	-	-	354.9	-	-						
216.5	-	-	-	325.2	-	-	-	321.9	-	-						
229.7	-	-	-	304.2	-	-	-	291.0	-	-						
242.8	-	-	-	285.5	-	-	-	264.6	-	-						
255.9	-	-	-	269.0	-	-	-	240.3	-	-						
269.0	-	-	-	-	-	-	-	219.4	-	-						
282.2	-	-	-	-	204.4	-	-	199.5	-	-						
295.3	-	-	-	-	193.6	-	-	180.8	-	-						
308.4	-	-	-	-	-	164.2	-	164.2	-	-						
321.5	-	-	-	-	-	-	144.4	144.4	-	-						
334.6	-	-	-	-	-	-	125.2	124.6	-	-						
347.8	-	-	-	-	-	-	117.9	106.3	-	-						
360.9	-	-	-	-	-	-	-	88.6	-	-						
374.0	-	-	-	-	-	-	-	79.6	-	-						
387.1	-	-	-	-	-	-	-	62.6	-	-						
65.6	393.5*	418.9*	-	-	-	-	-	-	-	-						
72.2	369.3*	418.9*	-	-	-	-	-	-	-	-						
78.7	342.8*	413.4*	-	-	-	-	-	-	-	-						
85.3	318.6*	425.5	-	-	-	-	-	-	410.1	-						
91.9	297.6*	423.3	-	-	-	-	-	-	410.1	-						
98.4	278.9*	418.9	-	-	-	-	-	-	410.1	-						
111.5	248.0*	406.8	-	-	-	-	-	-	410.1	-						
124.7	221.6*	392.4	-	-	-	-	-	-	410.1	-						
137.8	200.2*	379.2	-	-	-	-	-	-	410.1	-						
150.9	179.5*	366.0	-	-	-	-	-	-	403.4	-						
164.0	158.3*	354.9	416.7	-	-	-	-	-	399.0	-						
177.2	140.2*	342.8	413.4	-	-	-	-	-	388.0	-						
190.3	-	-	401.2	-	-	-	-	-	372.6	-						
203.4	-	-	391.3	-	-	-	-	-	361.6	-						
216.5	-	-	363.8	-	-	-	-	-	328.5	-						
229.7	-	-	338.4	-	-	-	-	-	297.6	-						
242.8	-	-	316.4	275.6	-	-	-	-	271.2	-						
255.9	-	-	-	257.9	-	-	-	-	246.9	-						
269.0	-	-	-	243.6	-	-	-	-	224.9	-						
282.2	-	-	-	229.3	-	-	-	-	205.0	-						
295.3	-	-	-	218.0	-	-	-	-	186.3	-						
308.4	-	-	-	-	172.6	-	-	-	169.8	-						
321.5	-	-	-	-	163.6	-	-	-	154.3	-						
334.6	-	-	-	-	155.6	-	-	-	138.9	-						
347.8	-	-	-	-	-	-	-	-	122.4	-						
360.9	-	-	-	-	-	-	-	-	105.6	-						
374.0	-	-	-	-	-	-	-	-	89.7	-						
387.1	-	-	-	-	-	-	-	-	74.5	-						
400.3	-	-	-	-	-	-	-	-	66.8	-						
413.4	-	-	-	-	-	-	-	-	52.5	-						
426.5	-	-	-	-	-	-	-	-	38.1	-						

* Main boom angle 87°

Main boom angle 87°, 85°, 75°, 65°, 55° and 45°, capacities for intermediate boom positions are calculated by the crane control system IC-1

	0 lb	176,400 lb	352,800 lb	529,200 lb	705,600 lb	882,000 lb	992,100 lb
--	------	------------	------------	------------	------------	------------	------------

Operation

SWSL, SFSL

374,800 – 551,200 lb + 0 – 176,400 lb 49.2–78.7 ft 31.5 ft 32.2 ft/s 360° ASME B30.5												
315.0 ft + 196.9 ft						315.0 ft + 236.2 ft						
SWSL			SFSL			SWSL			SFSL			
0 lb			176,400 lb – 992,100 lb			0 lb			176,400 lb – 992,100 lb			
87°/85°		87°/85°		75°		65°		55°		45° 15°		
1,000 lb						1,000 lb						
ft						ft						
78.7	315.3*	340.6*	-	-	-	85.3	261.2*	274.5*	-	-	-	
85.3	298.7*	337.3*	-	-	-	91.9	253.5*	272.3*	-	-	-	
91.9	278.9*	334.0*	-	-	-	98.4	242.5*	270.1*	-	-	-	
98.4	261.2*	345.0	-	-	-	105.0	228.2*	276.7	-	-	-	
111.5	231.5*	338.4	-	-	-	111.5	213.8*	275.6	-	-	266.8	
124.7	207.0*	330.7	-	-	-	124.7	190.3*	272.3	-	-	266.8	
137.8	186.1*	320.8	-	-	-	137.8	170.4*	266.8	-	-	266.8	
150.9	168.2*	312.0	-	-	-	150.9	153.4*	261.2	-	-	266.8	
164.0	153.0*	302.0	-	-	-	164.0	138.7*	253.5	-	-	266.8	
177.2	139.8*	293.2	-	-	-	177.2	125.9*	246.9	-	-	266.8	
190.3	126.5*	284.4	336.2	-	-	190.3	114.6*	240.3	-	-	266.8	
203.4	112.9*	276.7	331.8	-	-	203.4	104.3*	233.7	266.8	-	262.4	
216.5	87.7	267.9	326.3	-	-	216.5	92.8*	228.2	266.8	-	255.7	
229.7	-	-	316.4	-	-	229.7	82.7*	221.6	263.5	-	244.7	
242.8	-	-	309.7	-	-	242.8	73.6*	215.8	260.1	-	238.1	
255.9	-	-	297.6	-	-	255.9	54.0	209.9	254.6	-	231.5	
269.0	-	-	280.0	239.2	-	269.0	-	-	248.0	-	227.1	
282.2	-	-	-	224.9	-	282.2	-	-	243.6	-	217.2	
295.3	-	-	-	213.4	-	295.3	-	-	239.2	203.5	198.4	
308.4	-	-	-	201.9	-	308.4	-	-	226.0	192.2	181.9	
321.5	-	-	-	191.6	-	321.5	-	-	-	181.9	165.3	
334.6	-	-	-	-	149.9	334.6	-	-	-	172.4	151.0	
347.8	-	-	-	-	142.2	347.8	-	-	-	163.6	137.8	
360.9	-	-	-	-	135.1	360.9	-	-	-	155.6	124.6	
374.0	-	-	-	-	127.9	374.0	-	-	-	-	113.5	
387.1	-	-	-	-	-	387.1	-	-	-	116.0	100.5	
400.3	-	-	-	-	-	400.3	-	-	-	109.1	87.3	
413.4	-	-	-	-	77.4	413.4	-	-	-	102.7	74.3	
426.5	-	-	-	-	72.5	426.5	-	-	-	96.8	61.9	
439.6	-	-	-	-	-	439.6	-	-	-	-	52.0	
452.8	-	-	-	-	-	452.8	-	-	-	54.0	43.0	
465.9	-	-	-	-	-	465.9	-	-	-	50.0	32.8	
					20.1	479.0	-	-	-	-	21.8	

* Main boom angle 87°

Main boom angle 87°, 85°, 75°, 65°, 55° and 45°, capacities for intermediate boom positions are calculated by the crane control system IC-1

	0 lb	176,400 lb	352,800 lb	529,200 lb	705,600 lb	882,000 lb	992,100 lb
--	------	------------	------------	------------	------------	------------	------------

Operation

SWSL, SFSL

																							
																							
SWSL			SFSL			SWSL			SFSL														
0 lb			176,400 lb - 992,100 lb			0 lb			176,400 lb - 992,100 lb														
87°/85°			87°/85°			75°			65°			55°			45°			15°					
ft												1,000 lb											
98.4	213.0*	220.2*	-	-	-	-	-	-	-	-	-	105.0	165.1*	171.3*	-	-	-	-	-	-	-	-	
111.5	200.2*	216.9*	-	-	-	-	-	-	-	-	-	111.5	165.1*	170.6*	-	-	-	-	-	-	-	-	
118.1	188.9*	221.6	-	-	-	-	-	-	-	-	-	124.7	159.4*	171.1	-	-	-	-	-	-	-	-	
124.7	177.7*	221.6	-	-	-	-	-	-	-	-	213.8	137.8	146.4*	170.2	-	-	-	-	-	-	-	165.3	
137.8	158.5*	218.7	-	-	-	-	-	-	-	-	213.8	150.9	130.7*	168.4	-	-	-	-	-	-	-	165.3	
150.9	142.2*	215.4	-	-	-	-	-	-	-	-	213.8	164.0	117.3*	166.2	-	-	-	-	-	-	-	165.3	
164.0	128.3*	211.4	-	-	-	-	-	-	-	-	213.8	177.2	105.4*	163.6	-	-	-	-	-	-	-	165.3	
177.2	115.7*	207.0	-	-	-	-	-	-	-	-	213.8	190.3	94.8*	160.5	-	-	-	-	-	-	-	165.3	
190.3	104.9*	202.2	-	-	-	-	-	-	-	-	213.8	203.4	85.3*	157.2	-	-	-	-	-	-	-	165.3	
203.4	95.2*	197.5	-	-	-	-	-	-	-	-	213.8	216.5	77.2*	154.1	-	-	-	-	-	-	-	164.2	
216.5	86.6*	192.7	212.7	-	-	-	-	-	-	-	213.8	229.7	69.4*	150.8	159.0	-	-	-	-	-	-	164.2	
229.7	78.3*	188.3	212.7	-	-	-	-	-	-	-	211.6	242.8	62.6*	147.5	159.0	-	-	-	-	-	-	163.1	
242.8	69.2*	183.6	211.4	-	-	-	-	-	-	-	202.8	255.9	56.2*	144.4	159.0	-	-	-	-	-	-	157.6	
255.9	61.3*	179.2	211.0	-	-	-	-	-	-	-	197.3	269.0	48.9*	141.3	159.0	-	-	-	-	-	-	153.2	
269.0	54.0*	174.6	207.2	-	-	-	-	-	-	-	191.8	282.2	42.5*	138.2	157.9	-	-	-	-	-	-	148.8	
282.2	47.4*	170.2	205.3	-	-	-	-	-	-	-	188.5	295.3	36.6*	135.1	157.0	-	-	-	-	-	-	145.5	
295.3	31.3	165.6	203.3	-	-	-	-	-	-	-	184.1	308.4	31.1*	132.1	156.3	-	-	-	-	-	-	142.2	
308.4	-	-	197.5	182.3	-	-	-	-	-	-	180.8	321.5	26.0*	128.8	154.3	-	-	-	-	-	-	140.0	
321.5	-	-	194.2	174.4	-	-	-	-	-	-	169.8	334.6	12.1	125.7	152.6	135.6	-	-	-	-	-	136.7	
334.6	-	-	190.9	164.9	-	-	-	-	-	-	154.3	347.8	-	-	150.8	135.6	-	-	-	-	-	133.4	
347.8	-	-	187.6	156.3	-	-	-	-	-	-	141.1	360.9	-	-	149.0	135.6	-	-	-	-	-	131.2	
360.9	-	-	-	148.2	-	-	-	-	-	-	127.9	374.0	-	-	145.1	133.4	-	-	-	-	-	119.0	
374.0	-	-	-	140.7	-	-	-	-	-	-	116.8	387.1	-	-	143.3	126.5	-	-	-	-	-	108.2	
387.1	-	-	-	133.8	-	-	-	-	-	-	105.8	400.3	-	-	-	120.2	-	-	-	-	-	97.9	
400.3	-	-	-	127.4	94.8	-	-	-	-	-	95.5	413.4	-	-	-	114.0	-	-	-	-	-	88.2	
413.4	-	-	-	-	89.1	-	-	-	-	-	83.3	426.5	-	-	-	108.2	75.6	-	-	-	-	78.0	
426.5	-	-	-	-	83.6	-	-	-	-	-	71.4	439.6	-	-	-	103.0	70.5	-	-	-	-	67.0	
439.6	-	-	-	-	78.5	-	-	-	-	-	60.0	452.8	-	-	-	-	65.9	-	-	-	-	56.4	
452.8	-	-	-	-	73.6	-	-	-	-	-	48.9	465.9	-	-	-	-	61.5	-	-	-	-	46.3	
465.9	-	-	-	-	-	-	-	-	-	-	37.9	479.0	-	-	-	-	57.1	-	-	-	-	36.4	
479.0	-	-	-	-	-	-	-	-	-	-	34.6	492.1	-	-	-	-	53.1	-	-	-	-	26.9	
492.1	-	-	-	-	-	-	-	-	-	-	31.5	505.3	-	-	-	-	-	-	-	-	20.1	19.2	
505.3	-	-	-	-	-	-	-	-	-	-	23.1	518.4	-	-	-	-	-	-	-	-	17.2	12.1	
518.4	-	-	-	-	-	-	-	-	-	-	13.4	531.5	-	-	-	-	-	-	-	-	14.6	-	

* Main boom angle 87°

Main boom angle 87°, 85°, 75°, 65°, 55° and 45°, capacities for intermediate boom positions are calculated by the crane control system IC-1

	0 lb	176,400 lb	352,800 lb	529,200 lb	705,600 lb	882,000 lb	992,100 lb
---	------	------------	------------	------------	------------	------------	------------

Operation

SWSL, SFSL

374,800 – 551,200 lb + 0 – 176,400 lb 49.2 – 78.7 ft 31.5 ft 32.2 ft/s 360° ASME B30.5

315.0 ft + 354.3 ft
 SWSL | SFSL
 0 lb | 176,400 lb – 992,100 lb
 87°/85° | 87°/85° | 75° | 65° | 55° | 45° | 15°

ft	1,000 lb						
111.5	125.2*	131.0*	-	-	-	-	-
124.7	125.2*	129.9*	-	-	-	-	-
137.8	124.1*	129.9	-	-	-	-	-
150.9	117.7*	129.2	-	-	-	-	125.7
164.0	106.5*	127.6	-	-	-	-	125.7
177.2	95.2*	125.9	-	-	-	-	125.7
190.3	84.9*	124.1	-	-	-	-	125.7
203.4	76.1*	122.1	-	-	-	-	125.7
216.5	67.7*	119.9	-	-	-	-	124.6
229.7	60.6*	117.7	-	-	-	-	123.5
242.8	53.8*	115.3	-	-	-	-	122.4
255.9	47.8*	113.1	117.1	-	-	-	121.3
269.0	42.3*	110.9	117.1	-	-	-	119.0
282.2	37.3*	108.7	117.1	-	-	-	115.7
295.3	32.0*	106.3	117.1	-	-	-	112.4
308.4	26.5*	104.1	116.8	-	-	-	111.3
321.5	21.4*	101.9	116.8	-	-	-	109.3
334.6	16.8*	99.6	116.0	-	-	-	107.6
347.8	12.6*	97.2	115.7	-	-	-	105.8
360.9	-	95.0	115.5	98.1	-	-	104.1
374.0	-	92.8	115.1	98.1	-	-	102.3
387.1	-	-	113.1	98.1	-	-	100.5
400.3	-	-	112.4	97.2	-	-	98.5
413.4	-	-	112.0	97.2	-	-	90.2
426.5	-	-	111.3	97.2	-	-	80.9
439.6	-	-	-	96.3	-	-	72.5
452.8	-	-	-	91.3	58.4	-	62.2
465.9	-	-	-	86.2	54.0	-	52.2
479.0	-	-	-	81.1	49.8	-	42.8
492.1	-	-	-	-	45.9	-	33.5
518.4	-	-	-	-	38.6	-	15.9
531.5	-	-	-	-	35.1	-	-

* Main boom angle 87°

Main boom angle 87°, 85°, 75°, 65°, 55° and 45°, capacities for intermediate boom positions are calculated by the crane control system IC-1

	0 lb	176,400 lb	352,800 lb	529,200 lb
	705,600 lb	882,000 lb	992,100 lb	

FIXED FLY JIB WITH SL



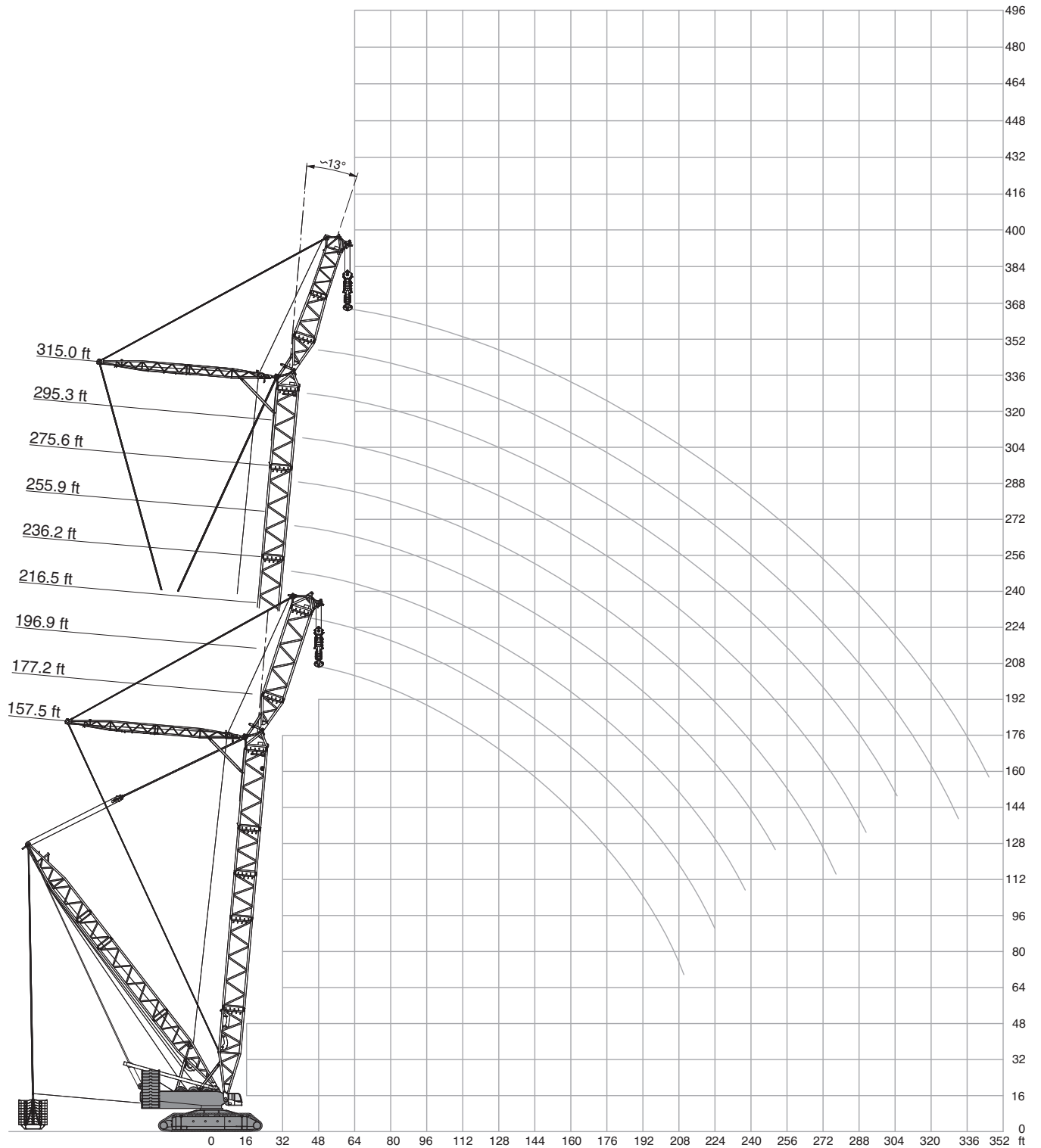

Operation

SFVL, LFVL

374,800-551,200 lb+ 0-176,400 lb 49.2-78.7 ft 59 ft 13° 31.5 ft 32.2 ft/s 360° ASME B30.5														
157.5 ft		177.2 ft		196.9 ft		216.5 ft		236.2 ft		255.9 ft	275.6 ft	295.3 ft	315.0 ft	
LFVL		SFVL		LFVL		SFVL		LFVL		SFVL		LFVL		
ft	1,000 lb													ft
45.9	1115.5	-	-	-	-	-	-	-	-	-	-	-	-	45.9
49.2	1115.5	1657.9	1115.5	1496.9	1115.5	-	-	-	-	-	-	-	-	49.2
52.5	1115.5	1638.0	1115.5	1496.9	1115.5	1366.9	1115.5	1236.8	1115.5	-	-	-	-	52.5
55.8	1115.5	1600.6	1115.5	1479.3	1115.5	1349.2	1115.5	1236.8	1115.5	1111.1	1009.7	908.3	-	55.8
59.1	1115.5	1547.6	1115.5	1479.3	1115.5	1349.2	1115.5	1236.8	1115.5	1111.1	1009.7	908.3	817.9	59.1
62.3	1115.5	1496.9	1115.5	1457.3	1115.5	1329.4	1115.5	1217.0	1115.5	1111.1	1009.7	908.3	817.9	62.3
65.6	1115.5	1450.6	1115.5	1417.6	1115.5	1329.4	1115.5	1217.0	1115.5	1095.7	1009.7	908.3	817.9	65.6
72.2	1115.5	1342.6	1115.5	1333.8	1115.5	1311.8	1115.5	1197.1	1115.5	1091.3	1009.7	908.3	817.9	72.2
78.7	1115.5	1221.4	1115.5	1212.5	1115.5	1203.7	1115.5	1179.5	1091.3	1075.9	994.3	906.1	817.9	78.7
85.3	1104.5	1117.7	1111.1	1108.9	1104.5	1100.1	1115.5	1091.3	1073.7	1058.2	978.9	892.9	817.9	85.3
91.9	1058.2	1029.6	1049.4	1020.7	1042.8	1011.9	1036.2	1003.1	1027.4	994.3	967.8	879.6	804.7	91.9
98.4	978.9	952.4	972.2	943.6	963.4	932.6	956.8	925.9	950.2	914.9	941.4	870.8	793.7	98.4
111.5	853.2	824.5	844.4	815.7	835.6	804.7	828.9	798.1	822.3	787.1	813.5	806.9	784.8	111.5
124.7	751.8	723.1	743.0	714.3	734.1	705.5	727.5	696.7	718.7	685.6	712.1	703.3	696.7	124.7
137.8	650.4	619.5	661.4	632.7	652.6	621.7	646.0	615.1	637.1	604.1	630.5	621.7	615.1	137.8
150.9	557.8	529.1	593.0	564.4	584.2	555.6	577.6	546.7	568.8	535.7	562.2	553.4	544.5	150.9
164.0	485.0	465.2	518.1	487.2	526.9	498.2	520.3	489.4	511.5	478.4	504.9	496.0	487.2	164.0
177.2	427.7	401.2	449.7	418.9	476.2	443.1	469.6	440.9	463.0	429.9	454.2	445.3	438.7	177.2
190.3	363.8	339.5	392.4	372.6	414.5	383.6	425.5	396.8	418.9	390.2	412.3	403.4	396.8	190.3
203.4	321.9	297.6	348.3	321.9	361.6	330.7	377.0	346.1	381.4	352.7	374.8	368.2	359.4	203.4
216.5	-	-	295.4	271.2	321.9	299.8	330.7	299.8	343.9	310.9	343.9	335.1	326.3	216.5
229.7	-	-	-	-	280.0	253.5	291.0	269.0	302.0	269.0	310.9	306.4	297.6	229.7
242.8	-	-	-	-	-	-	260.1	233.7	262.4	235.9	275.6	280.0	273.4	242.8
255.9	-	-	-	-	-	-	-	-	238.1	212.7	240.3	246.9	249.1	255.9
269.0	-	-	-	-	-	-	-	-	206.1	178.6	215.0	217.2	220.5	269.0
282.2	-	-	-	-	-	-	-	-	-	-	190.7	190.7	194.0	282.2
295.3	-	-	-	-	-	-	-	-	-	-	-	172.0	167.6	295.3
308.4	-	-	-	-	-	-	-	-	-	-	-	-	153.2	308.4
321.5	-	-	-	-	-	-	-	-	-	-	-	-	130.1	321.5
334.6	-	-	-	-	-	-	-	-	-	-	-	-	112.4	334.6

	0 lb	176,400 lb	352,800 lb	529,200 lb	705,600 lb	882,000 lb	992,100 lb
--	------	------------	------------	------------	------------	------------	------------

Notes to Lifting Capacity

Ratings are in compliance with EN 13000. They do not exceed 75% of tipping load, according to ASME B30.5.

Weight of hook blocks and slings is part of the load, and is to be deducted from the capacity ratings.
Consult operation manual for further details.

Note: Data published herein is intended as a guide only and shall not be construed to warrant applicability for lifting purposes.
Crane operation is subject to the computer charts and operation manual both supplied with the crane.

In some instances the superlift counterweight does not lift off the ground with the indicated load.

TECHNICAL DESCRIPTION



Technical Description

Crawler carrier

3-section carrier comprising of carbody with folded outriggers for the transport and two crawlers. Hydraulic pin connections between crawlers and carbody provide for easy assembly and removal to minimise width and weight for transportation.

Center pot	Bending- and torsion-resistant welded structure fabricated from high-strength fine grain structural steel.
Crawler side frames	Bending-resistant welded structure fabricated from high-strength fine grain structural steel. Centralized lubrication included as standard.
Crawlers	15 track rollers with hardened rolling surfaces. Raised position for both drive sprockets and idler wheels, drive sprockets and idler wheels provide load bearing capacity for erection, adjustable track tension. Each crawler is infinitely variable controlled, both independently and in opposite direction.
Power train	The tracks are powered by two hydraulic motors each through closed planetary gear units running in oil bath, equipped with spring-applied hydraulically released holding brakes. The gear units are of extremely compact design to fit within the width of the crawlers. Each crawler is infinitely variable controlled, both independently and in opposite direction. Quadro-Drive as standard.
Central ballast	176,400 lb.

Superstructure

Counterweight	551,200 lb.
Frame	Bending- and torsion-resistant welded structure fabricated from high-strength fine grain structural steel.
Drive EU Stage V / EPA Tier 4f	Two Mercedes-Benz diesel engines, type OM470LA, 6 cylinder, 2 x 320 kW (2 x 429 HP) at 1600 1/min, torque 2100 Nm at 1300 1/min. The engines comply with emission standard EU Stage V / EPA Tier 4f. Two pump distributions gearboxes with overall six variable displacement axial piston pumps and additional gear pumps. Stainless steel exhaust system with particle filter, SCR catalyzer and spark arrestor certificate. Engine cover for sound insulation. Fuel: 1 x 396 gallons, AdBlue: 2 x 22.5 gallons.
Rope drums	The standard superstructure equipment includes three rope drums – hoist 1, hoist 2 and boom hoist. The drums are powered by hydraulic motors through closed planetary gear units running in oil bath. All rope drums have spring-applied, hydraulically released multi-disk brakes and non-wearing hydraulic braking for load lowering. Rope ends H 1, 2, 3 and W 1, 2 equipped with quick-connect rope end fittings. Hoists H 1 and H 2 and A-frame with boom hoist are removable to minimise weight for transportation.
A-frame	Cylinders on superstructure to raise A-frame are included as standard.
Slew units	Powered by four hydraulic motors through closed, planetary gear unit running in oil bath. Spring-applied, hydraulically released holding brake and non-wearing hydraulic braking.
Control system	IC-1: Electronic proportional valve pilot control integrated in stored-program control system incl. diagnostics. Two colour monitors, load indicator operated via a touchscreen. Working speeds infinitely variable controlled by the lever position. Automatic power control for optimal utilisation of engine output. Standard working range limitation, ground pressure indicator as well as outrigger loading indicator.
Cabin	Comfortable cab with large windscreen and air-conditioning. Laminated glass all around, roof window, self-contained hot air heater, full instrumentation and crane controls. The cab can be tilted back for improved operator view of boom point. A camera system is installed to monitor the rope drums. For transportation, the cab swings in front of the superstructure to minimise width.
Electrical equipment	24 V system (2 batteries 12 V / 180 Ah).
Quick-connection	Hydraulic quick-disconnect fittings on carrier and superstructure facilitate removal to minimise weight for transportation as standard.

Optional equipment

Hydraulic cylinder A-frame	For self-assembly of crawlers.
Sideways outriggers	For erection of long boom systems.
Counterweight carrier	Total weight max. 992,100 lb, in combination with SL telescopic system.
PC outriggers	Outrigger base 45.9 ft x 45.9 ft. Alternatively to the crawlers.

Further options on request!

Technical Description

Boom configurations S and L	
SH:	Main boom: foot section 39.4 ft, inserts 19.7 ft, 34.5 ft and 39.4 ft (type 3328), boom head 4.9 ft. Main boom lengths: 118.1-315.0 ft.
SH / LH: (SGL variable)	Main boom: foot sections 39.4 ft, inserts 19.7 ft, 34.5 ft and 39.4 ft (type 3328), tapered insert, extended by inserts 19.7 ft and 39.4 ft (type 2822), top section 24.6 ft. Main boom lengths: 157.5-354.3 ft.
LH:	Main boom: foot section 39.4 ft, insert 34.5 ft (type 3328), tapered insert, extended by inserts 19.7 ft and 39.4 ft (type 2822), top section 24.6 ft. Main boom lengths: 157.5-374.0 ft.
SW:	Main boom: same as SH. Offset 87° to 65°. Luffing fly jib: foot section 14.8 ft, insert 39.4 ft (type 3328), tapered insert, insert 19.7 ft and inserts 39.4 ft (type 2822), top section 24.6 ft. Main boom lengths: 137.8-196.9 ft. Fly jib lengths: 98.4-315.0 ft.
SSL:	Main boom: same as SH. Superlift equipment. Main boom lengths: 137.8-315.0 ft.
SSL / LSL: (SGL 310 ft)	Main boom: foot section 39.4 ft, inserts 19.7 ft, 34.5 ft and 39.4 ft (type 2822), tapered insert, extended by inserts 19.7 ft and 39.4 ft (type 2822), top section 24.6 ft. Superlift equipment. Main boom lengths: 334.6-492.1 ft.
SSL / LSL S1:	Main boom: same as SSL, extended by boom power-kit + jib top section. Main boom lengths: 216.5-511.8 ft.
SWSL / SFSL:	Main boom: same as SH. Offset 87° to 45°. Luffing fly jib: same as SW. Superlift equipment. Main boom lengths: 157.5-315.0 ft. Fly jib lengths: 98.4-354.3 ft.
SFVL:	Main boom: same as SH. Superlift equipment. Fixed jib: foot section 14.8 ft, insert 39.4 ft (type 3328), additional SFVL-head included. Main boom lengths: 157.5-236.2 ft. Fly jib length: 59.0 ft.
LFVL:	Main boom: same as SH. Superlift equipment. Fixed jib: foot section 14.8 ft, tapered insert, top section 24.6 ft. Main boom lengths: 157.5-315.0 ft. Fly jib length: 59.0 ft.
+LF:	In addition to main boom configuration SH, SSL, SH/LH, SSL/LSL, SSL/LSL S1. Fly jib lengths: 49.2 ft, 68.9 ft, 88.6 ft, 108.3 ft. Fly jib offset: 15°, 20°, 30°. Runner on LF max. 52,900 lb as standard.
Pinning of boom	Hydraulic assisted pinning of boom sections is standard.
Reeving winch	Mounted on superstructure.
Operator aids	Electronic load indicator, hoist limit switch for boom movements, hydraulic boom backstops, anemometer.
Optional equipment	
Engine EU Stage IIIA / EPA Tier 3	Optional for non-regulated markets: Two Mercedes-Benz diesel engines, type OM460LA, 6 cylinder, 2 x 315 kW (2 x 422 HP) at 1800 1/min, torque 2000 Nm at 1300 1/min. The engines comply with emission standard EU Stage IIIA / EPA Tier 3. Stainless steel exhaust system with spark arrestor. Fuel: 1 x 396 gallons.
Power-kit for main boom S1	Consisting of max. 3 additional boom sections (2 of main boom, 1 of jib); Standard main boom 315.0 ft required.
Standard Superlift equipment	Mast 132.9 ft (type 2322), counterweight tray for max. 992,100 lb. Superlift radii 49.2 ft, 59.0 ft, 68.9 ft, 78.7 ft.
Variable Superlift equipment	Mast 132.9 ft (type 2322), counterweight tray for max 992,100 lb. Superlift radius infinitely variable during operation 49.2 to 78.7 ft. Vertical cylinder and stabilising system for Superlift counterweight.
Superlift with counterweight carrier	Mast 132.9 ft (type 2322), counterweight carrier for max. 992,100 lb. Superlift radius infinitely variable during operation 59.0 to 78.7 ft.
Add on SL radius	78.7 ft – 98.4 ft (tray and carrier), only SSL, SSL/LSL and SSL/LSL S1.
Hoist H3	Additional rope drum on main boom (for LF or runner operation). Line pull same as H1, rope length 2297 ft.
Runnet 101,400 lb	Approx. 6.6 ft for installation on boom head or top section.
Fall protection	Fall protection system for main boom, fly jib and superlift mast.
S3-boom-kit LF3	For wind power applications without Superlift, hook heights from 367.5 ft – 433.1 ft.

fac.sales@tadano.com
www.tadanoamericas.com

Tadano Europe Holdings GmbH

Dinglerstraße 24, 66482 Zweibrücken, Germany
Phone +49 6332 830

Tadano America Corporation

4242 West Greens Road, Houston, TX 77066
Phone: +1 (281) 869-00300 · Fax: +1 (281) 869-0040



Lifting your dreams

